

Teoria maszyn i podstawy automatyki

zima 2019/2020

Przykład wyznaczania prędkości i przyspieszeń mechanizmu płaskiego metodą wykreślną

Dane: geometria mechanizmu (wymiary elementów, ich położenie i orientacja) oraz stała prędkość kątowa ω elementu napędowego

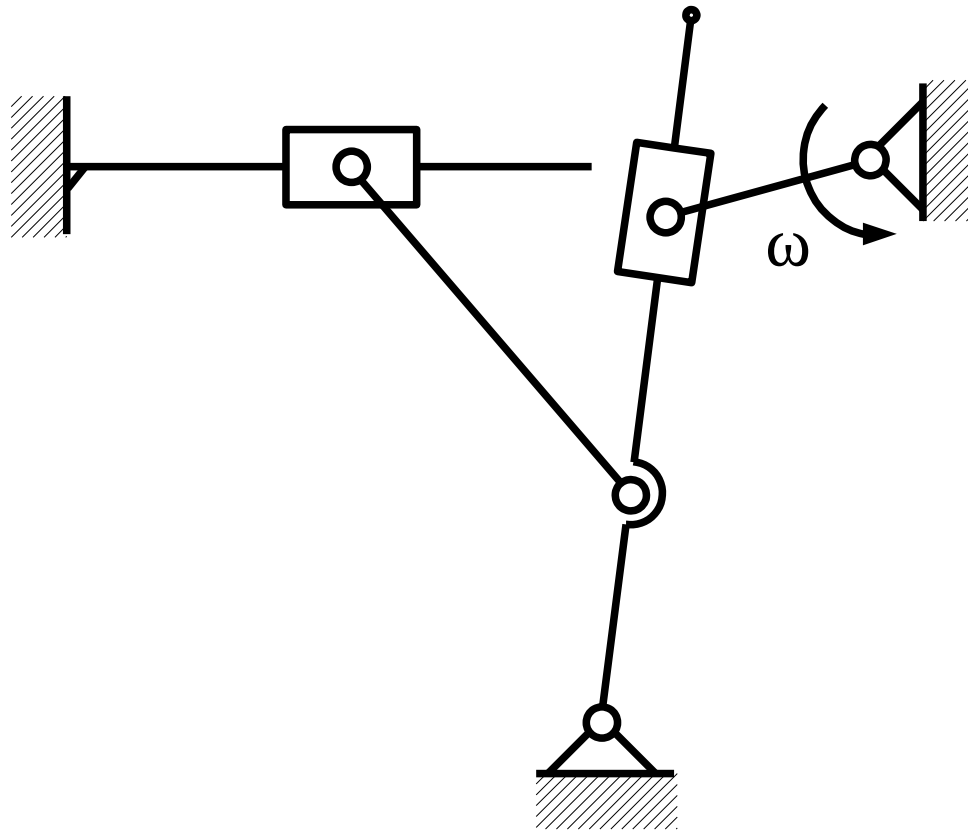

Jak pracuje ten mechanizm?

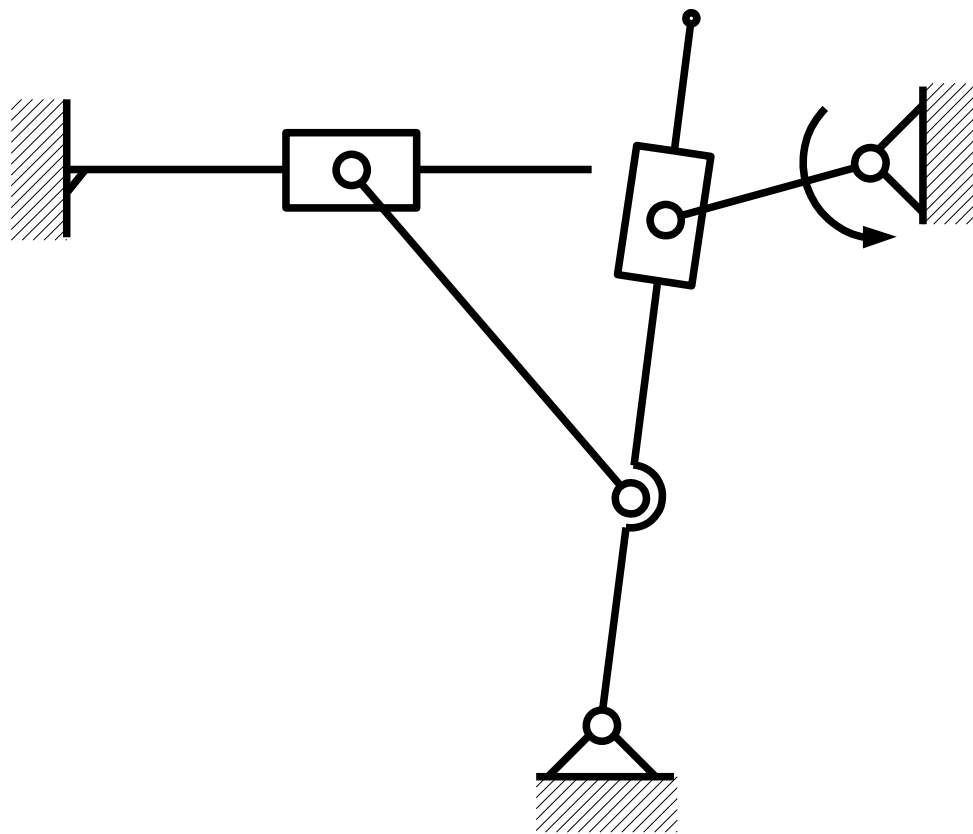

Jak pracuje ten mechanizm?

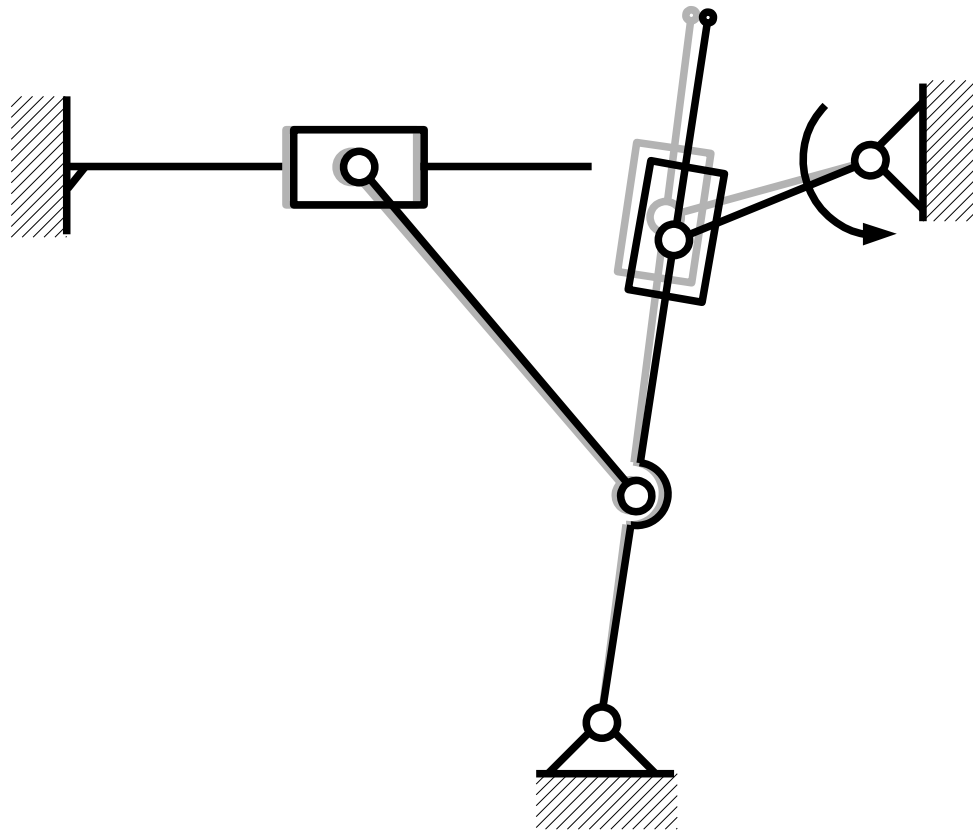

Jak pracuje ten mechanizm?

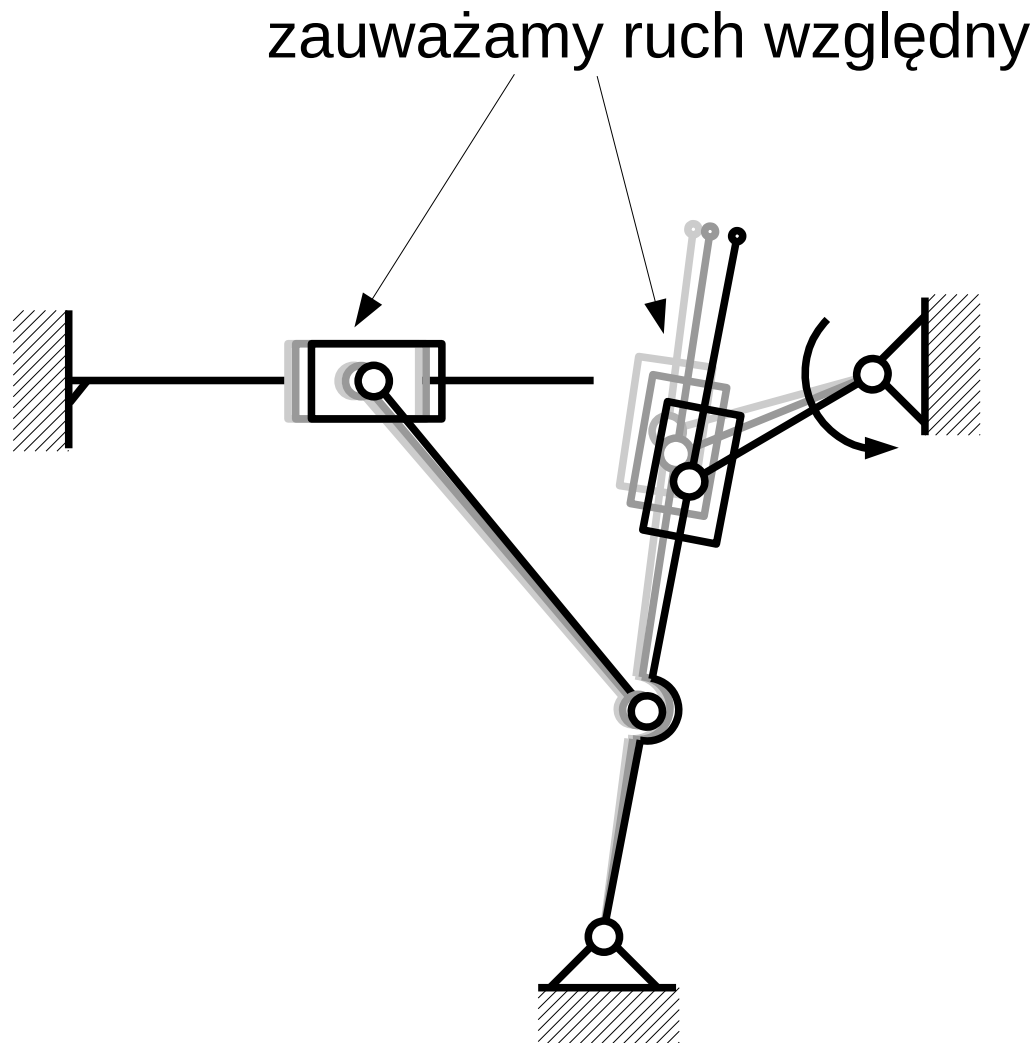

Wracamy do rozważanego położenia mechanizmu,
numerujemy człony i nazywamy punkty

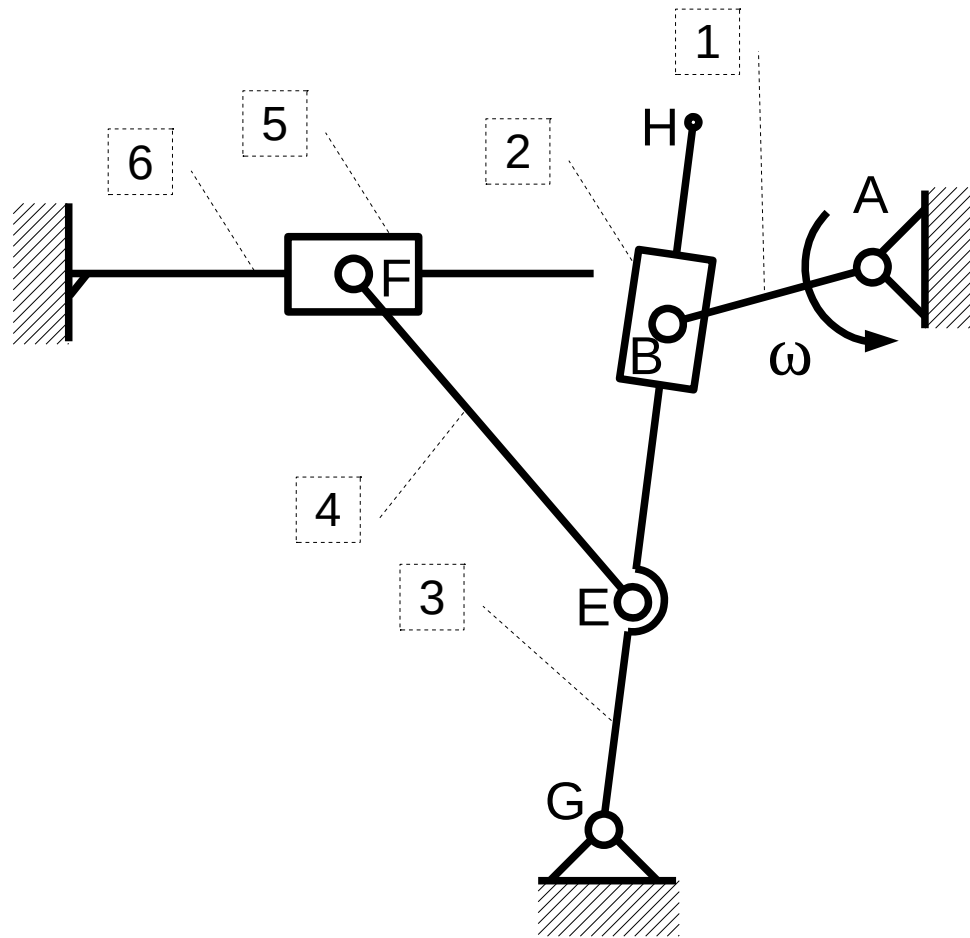

Ze względu na ruch względny suwaka 2 po pręcie 3 wprowadzamy oznaczenia punktów B_2 i B_3

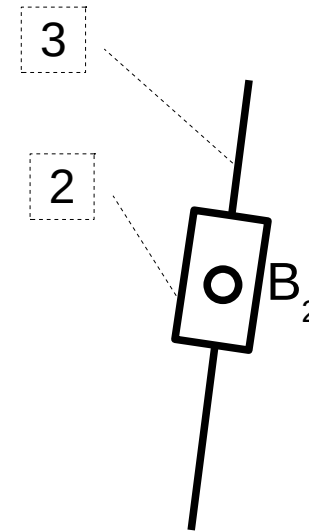
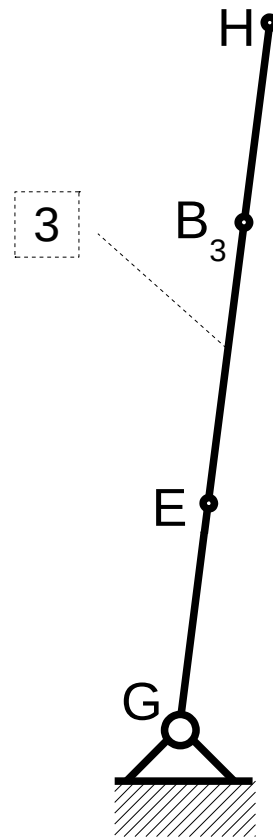
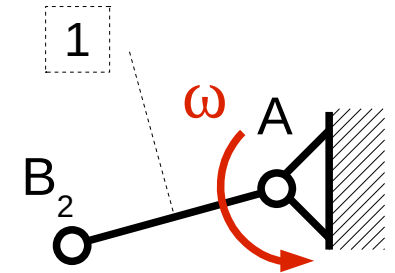
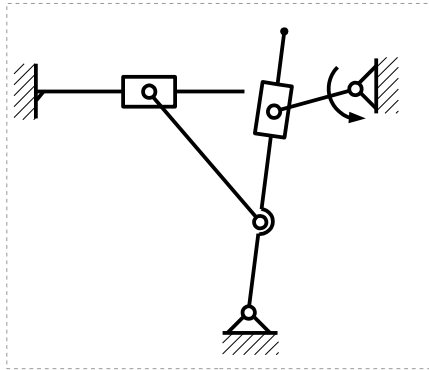

Wyznaczamy prędkość końca członu 1

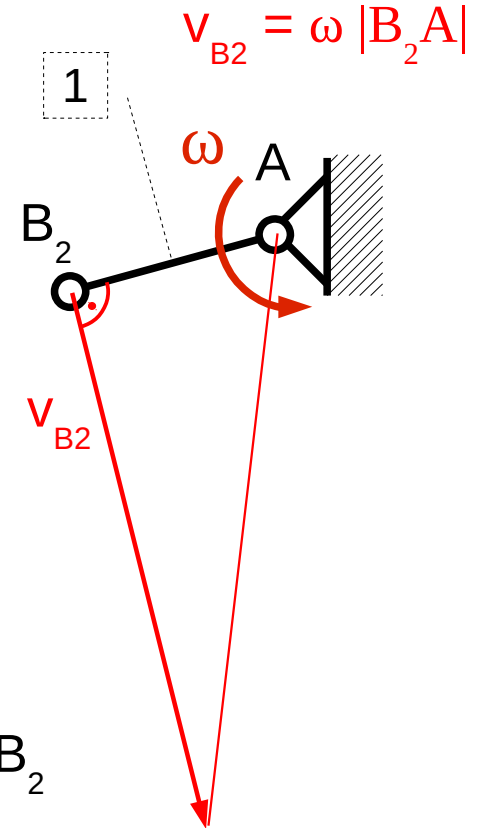
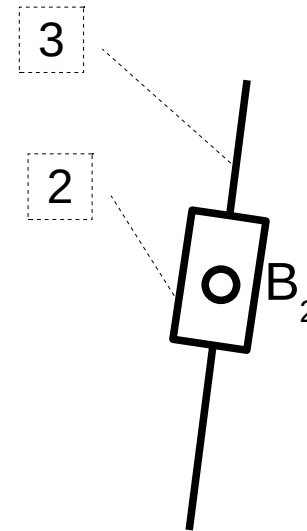
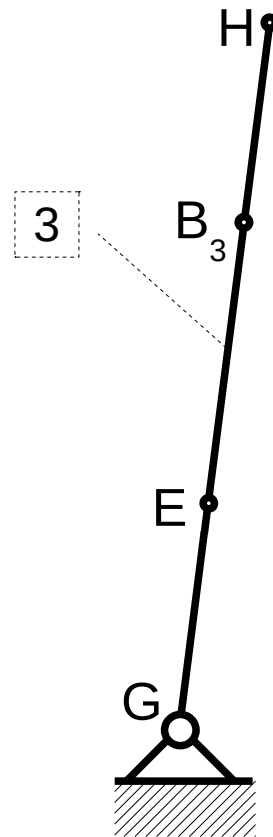
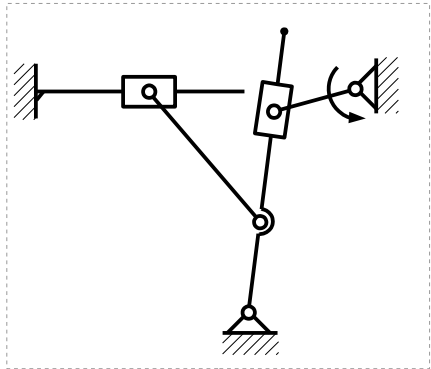

Przyjmujemy, że ruchem złożonym porusza się suwak 2,
 ruchem unoszenia jest zatem ruch pręta 3,
 a ruchem względnym - ruch suwaka wzdłuż pręta

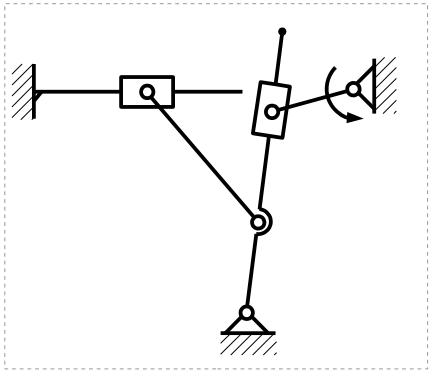

$$V_{B2} = V_{B3} + V_{B2B3}$$

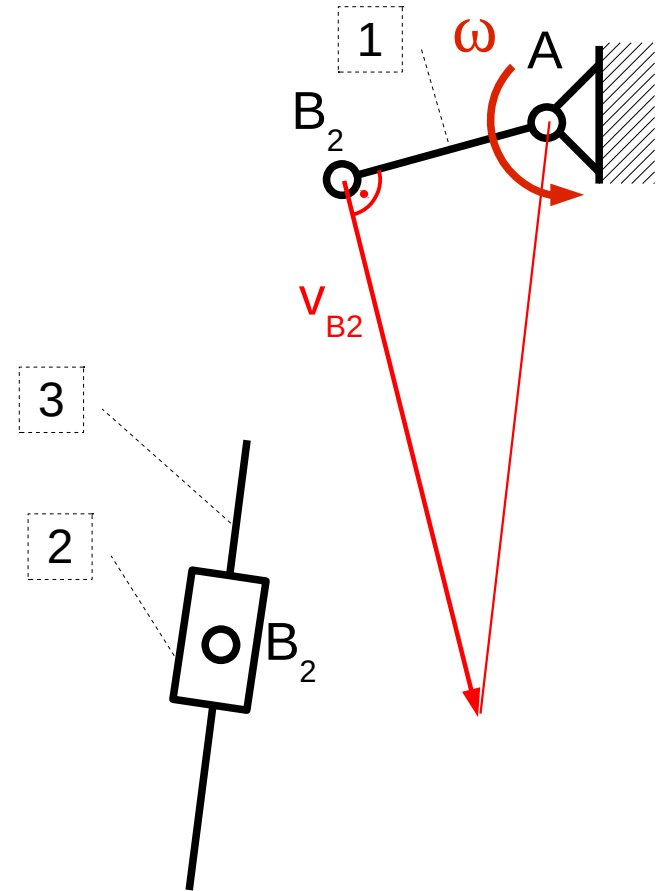
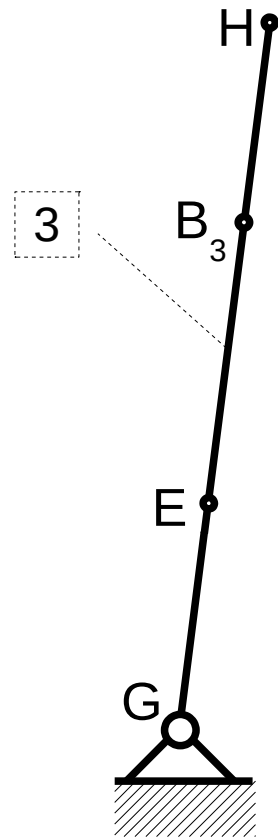

Określamy kierunki prędkości w równaniu ruchu względnego

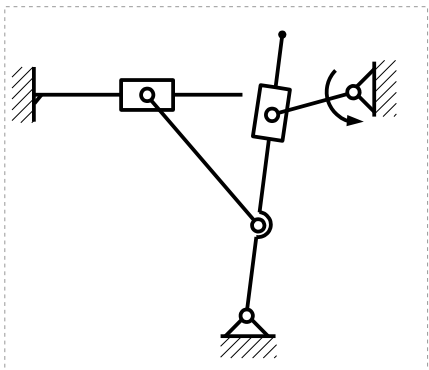

$$\frac{V_{B2}}{\perp 1} = \frac{V_{B3}}{\perp 3} + \frac{V_{B2B3}}{\parallel 3}$$

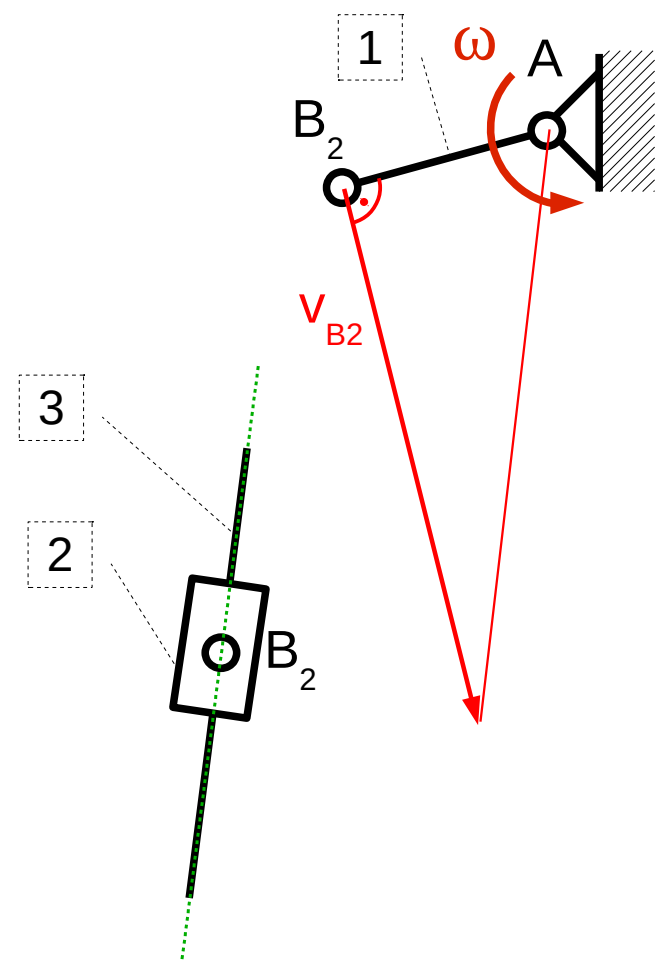
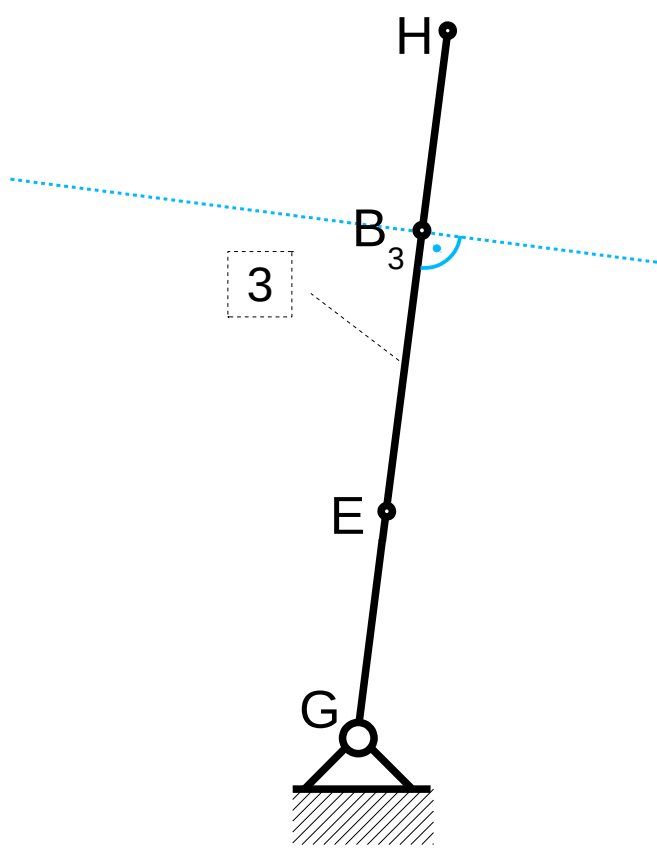

Plan prędkości

$$\underline{\underline{V_{B2}}} = \frac{V_{B3}}{\perp 3} + \frac{V_{B2B3}}{\parallel 3}$$



Plan prędkości

$$\underline{\underline{V_{B2}}} = \frac{V_{B3}}{\perp 3} + \frac{V_{B2B3}}{\parallel 3}$$

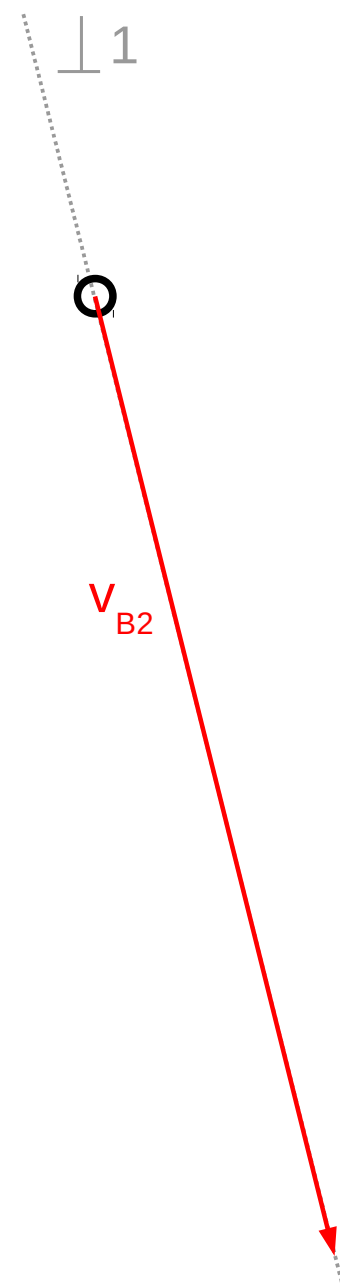

Plan prędkości

$$\underline{\underline{v_{B2}}} = \underline{\underline{v_{B3}}} + \frac{v_{B2B3}}{\parallel 3}$$

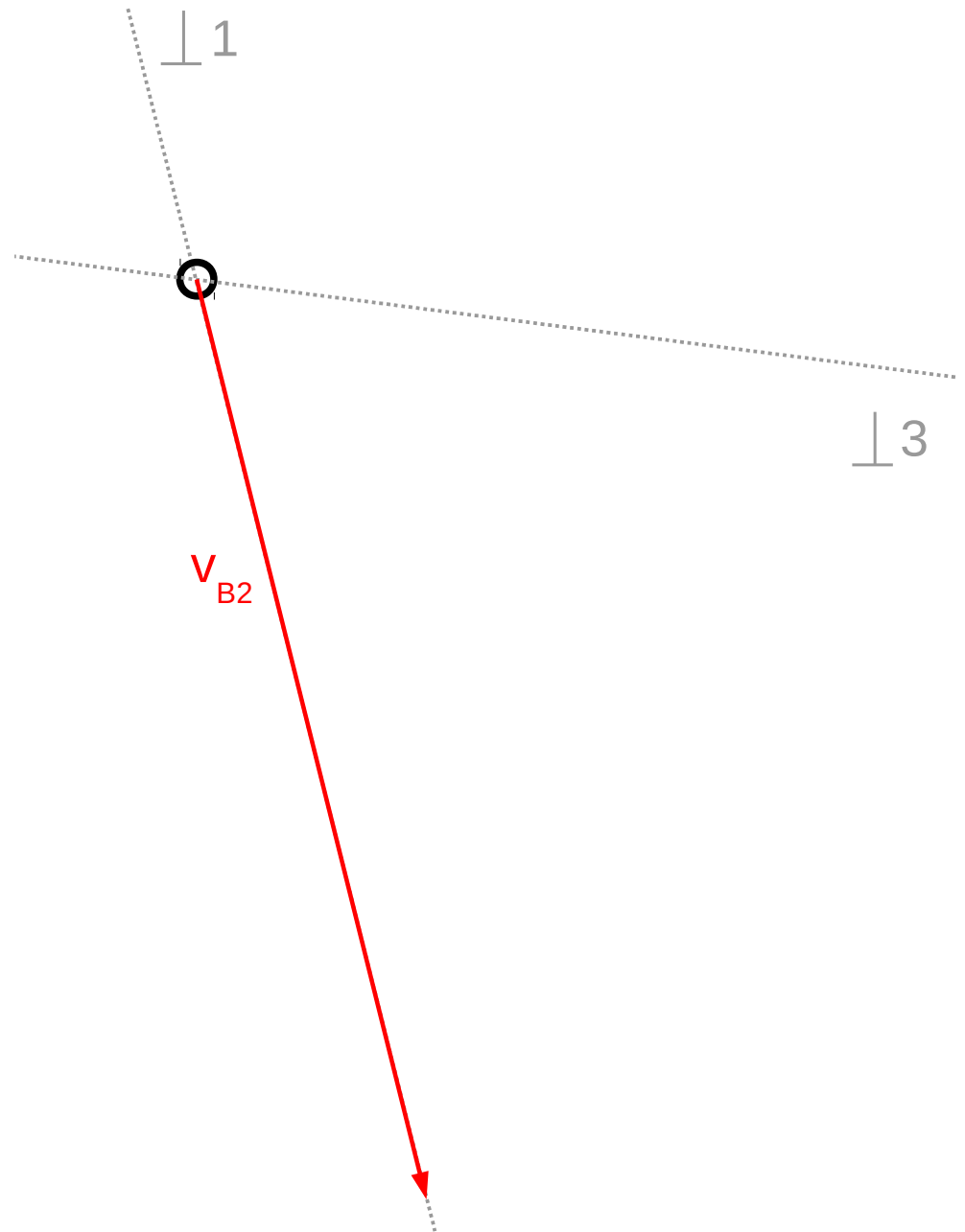

Plan prędkości

$$\underline{\underline{v_{B2}}} = \frac{v_{B3}}{\perp 3} + \frac{v_{B2B3}}{\parallel 3}$$

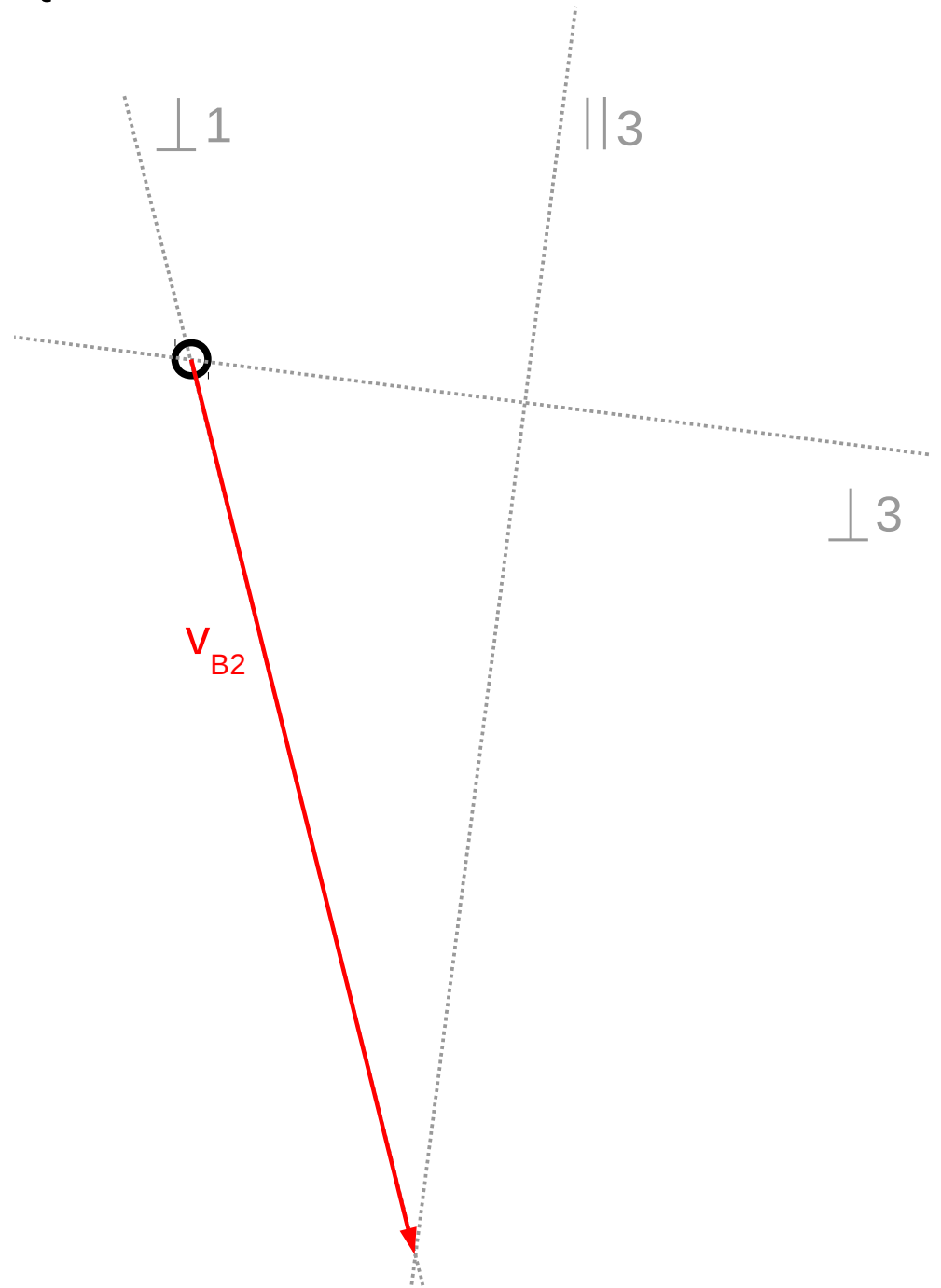

Plan prędkości

$$\underline{\underline{v_{B2}}} = \underline{\underline{v_{B3}}} + \underline{\underline{v_{B2B3}}}$$

The equation shows the decomposition of velocity v_{B2} into components v_{B3} and v_{B2B3} . The first term is enclosed in a red oval, the second in a blue oval, and the third in a dashed grey oval.

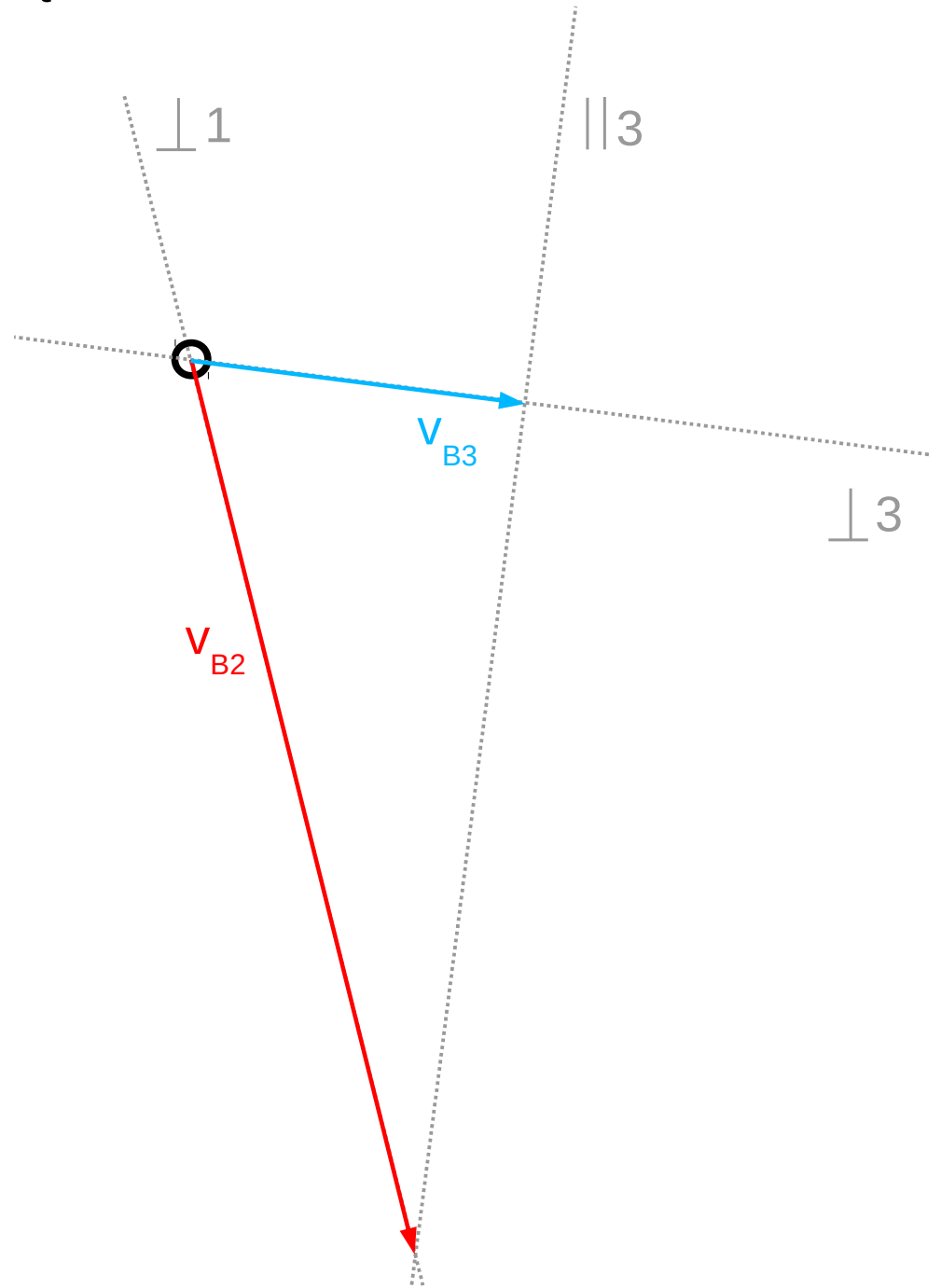

Plan prędkości

$$\underline{\underline{v_{B2}}} = \underline{\underline{v_{B3}}} + \underline{\underline{v_{B2B3}}}$$

The equation shows the decomposition of velocity v_{B2} into components v_{B3} and v_{B2B3} . The terms are enclosed in colored ovals: red for v_{B2} , blue for v_{B3} , and green for v_{B2B3} . The components are also labeled with their orientations relative to a reference axis: v_{B3} is perpendicular (\perp) to axis 3, and v_{B2B3} is parallel (\parallel) to axis 3.

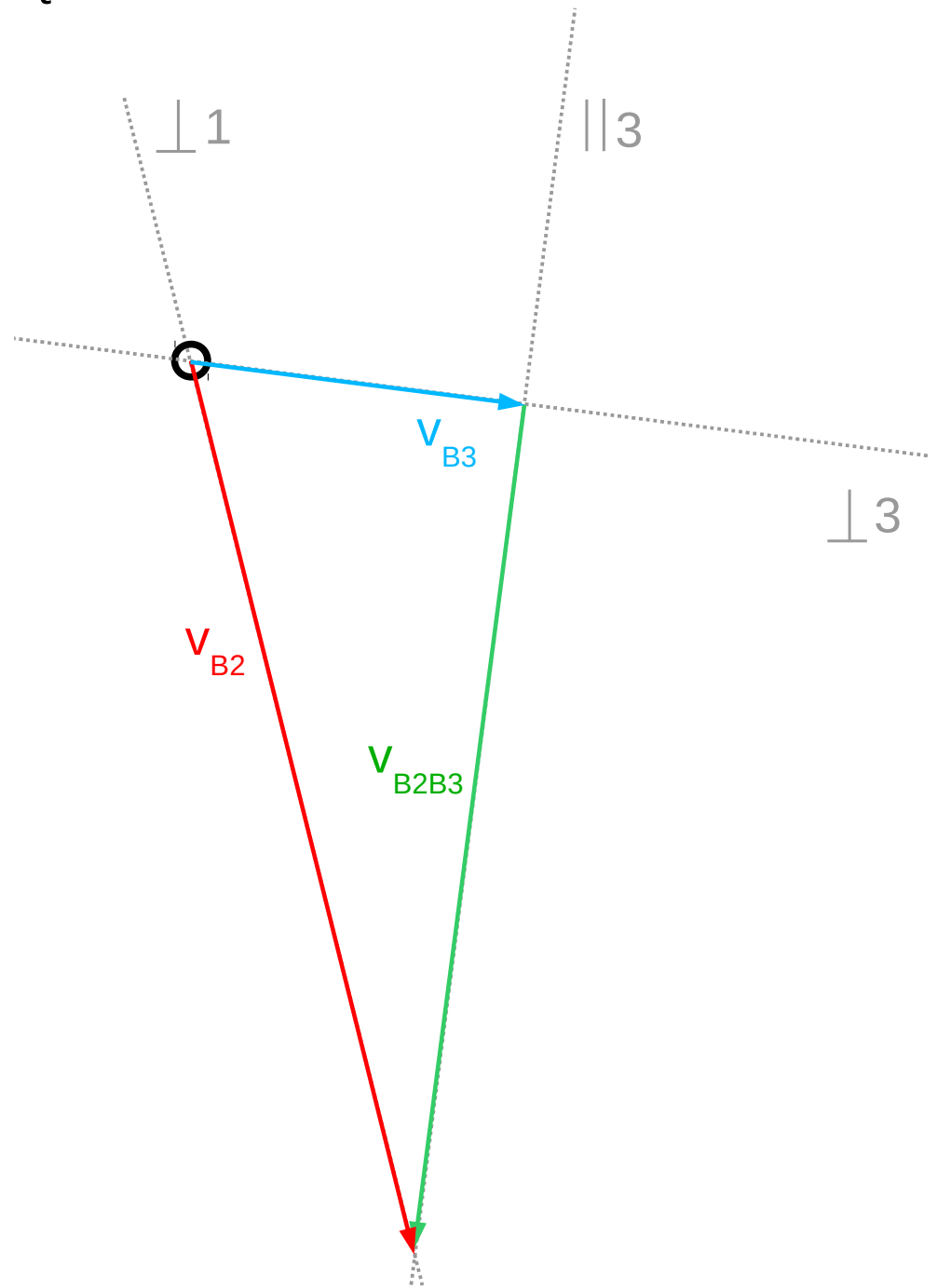

Wyznaczona prędkość punktu B_3 i prędkość względną

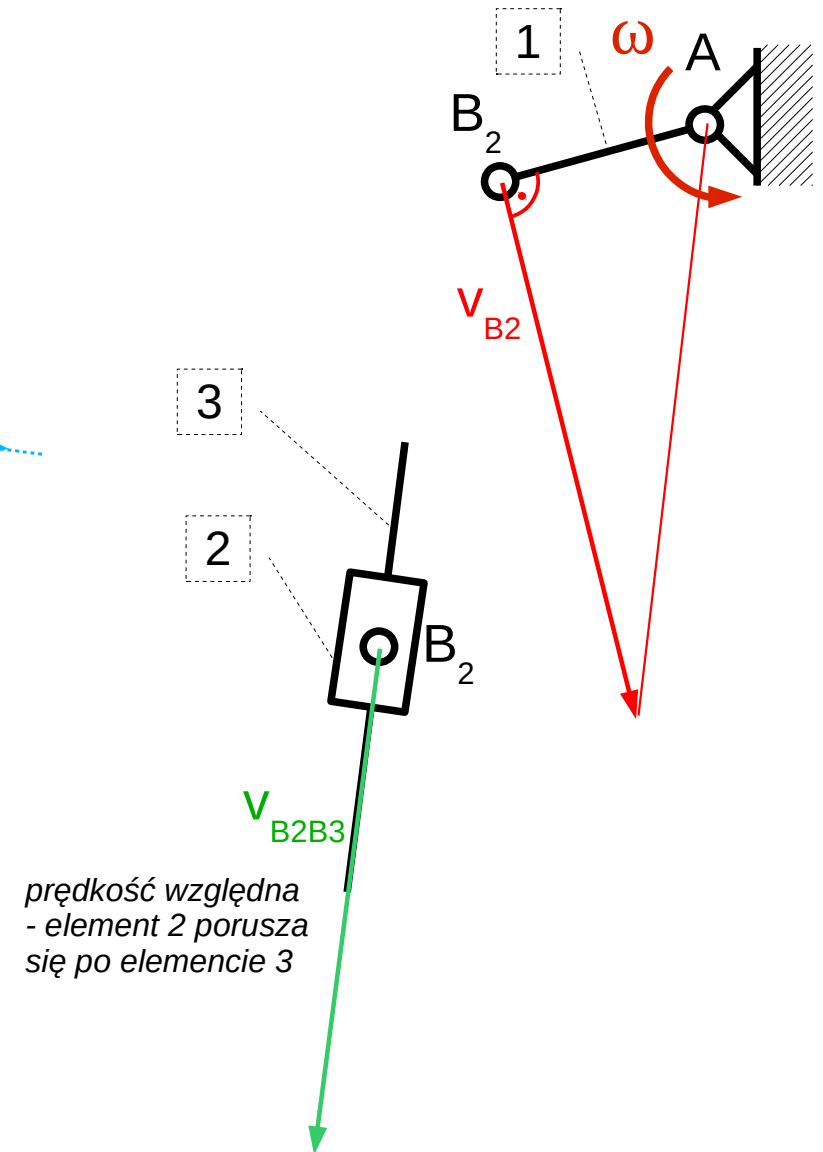
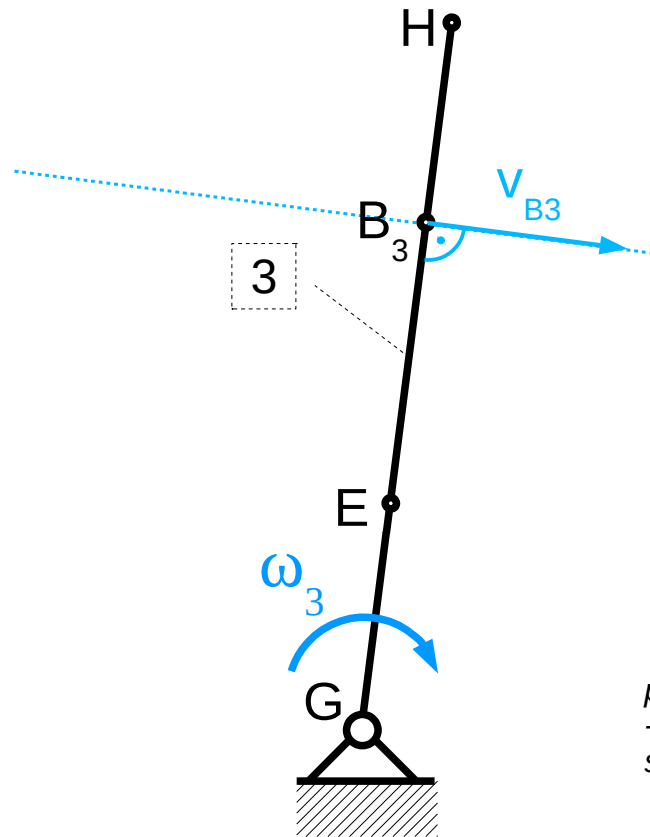
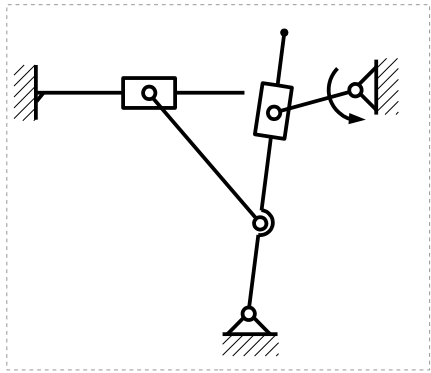

Z wyznaczonej prędkości punktu B_3 określamy prędkość kątową członu 3

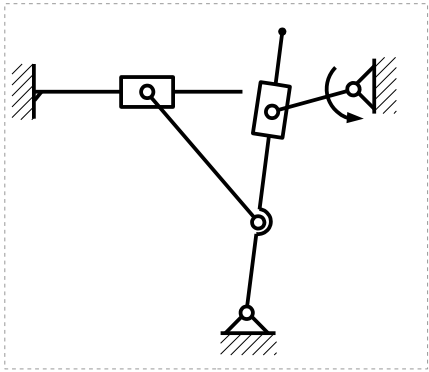

$$\omega_3 = \frac{v_{B3}}{|B_3G|}$$

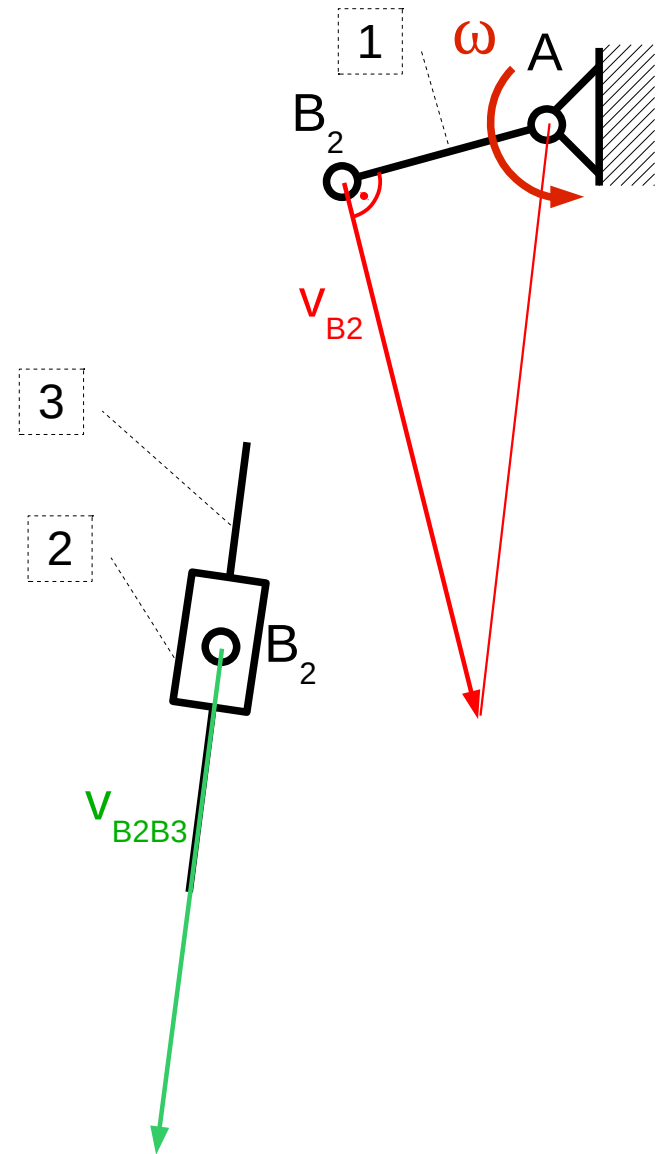
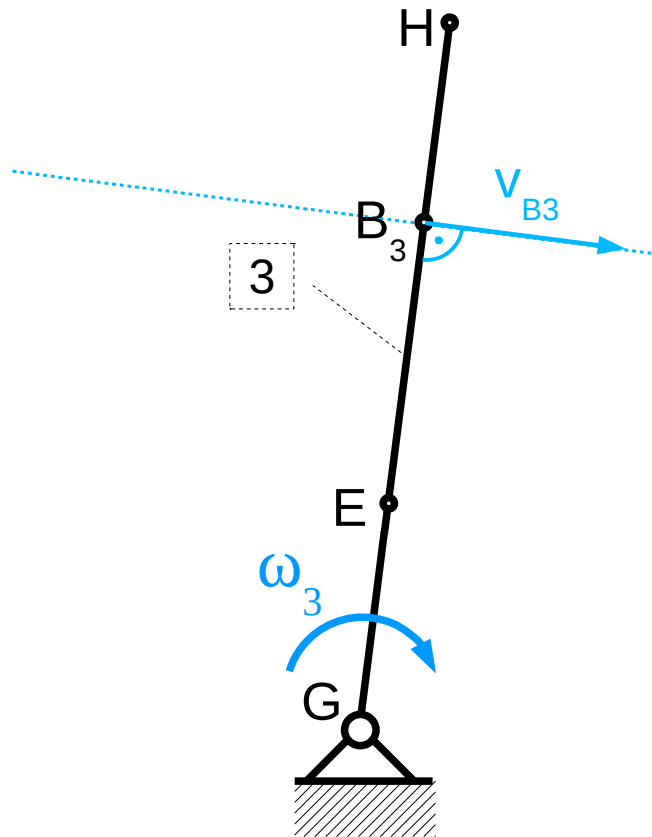

Dzięki wyznaczeniu prędkość kątową członu 3 znajdziemy teraz prędkość dowolnego punktu członu 3, np. punktu E i H

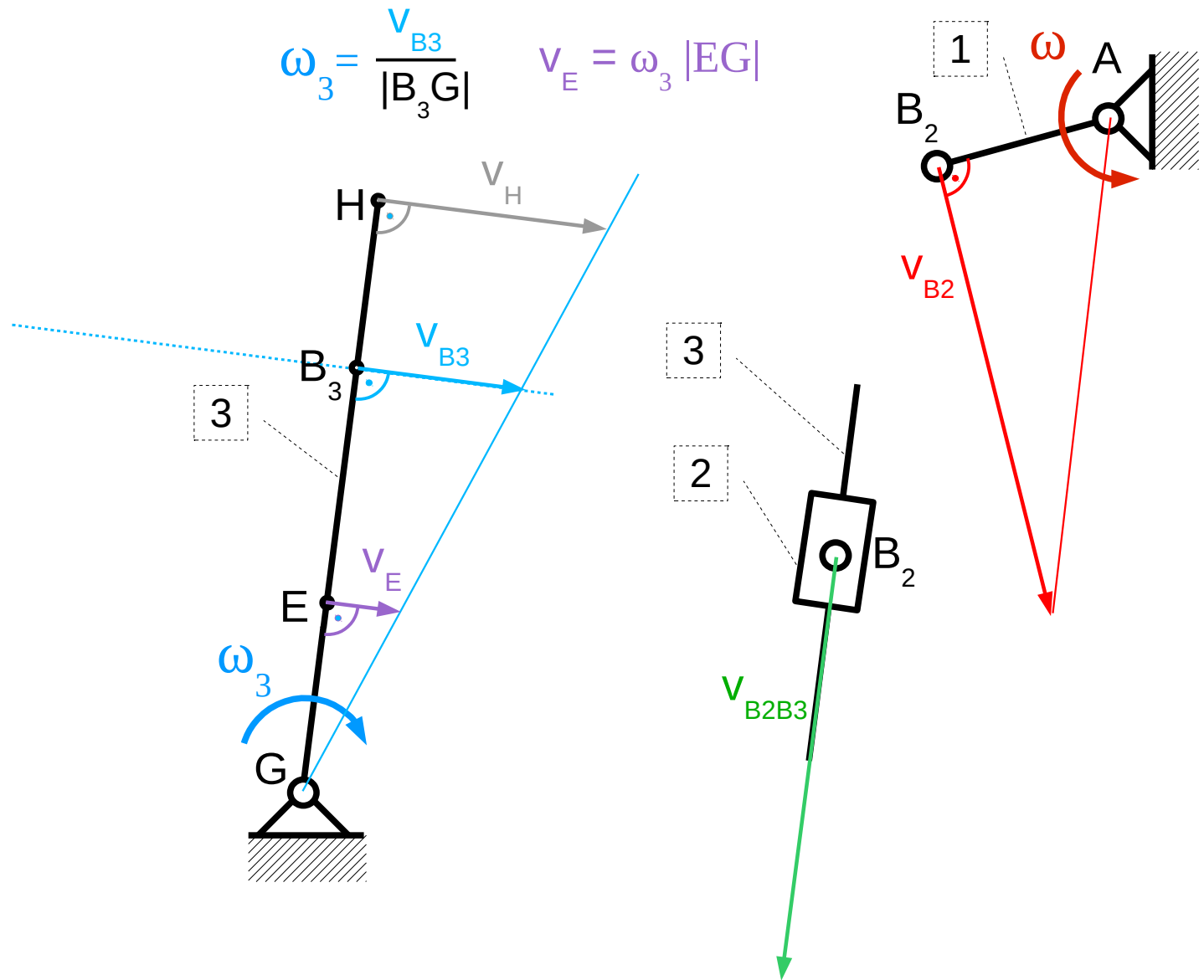
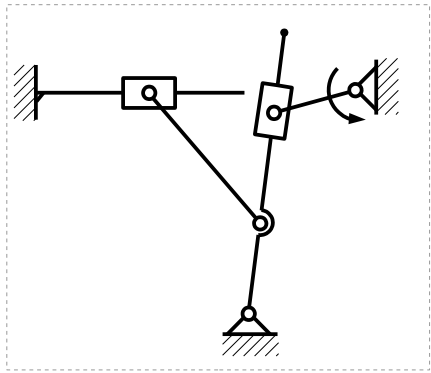

Prędkość punktu E oznaczmy też na planie prędkości

$$\underline{\underline{v_{B2}}} = \frac{v_{B3}}{\perp 3} + \frac{v_{B2B3}}{\parallel 3}$$

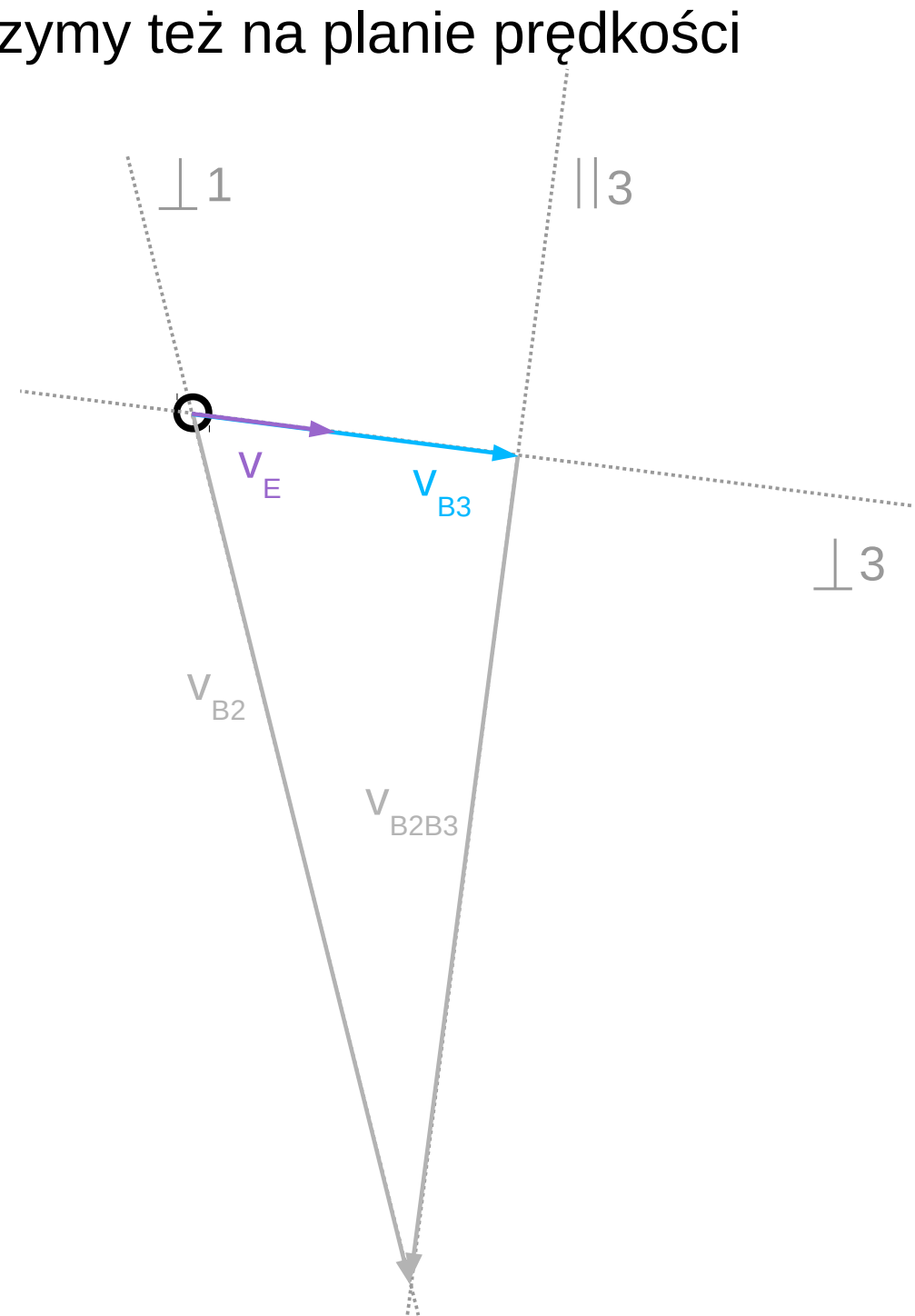

Z proporcji długości odcinków BG i BA oraz długości wektorów V_{B_3} i V_{B_2} wynika, że

$$\omega > \omega_3$$

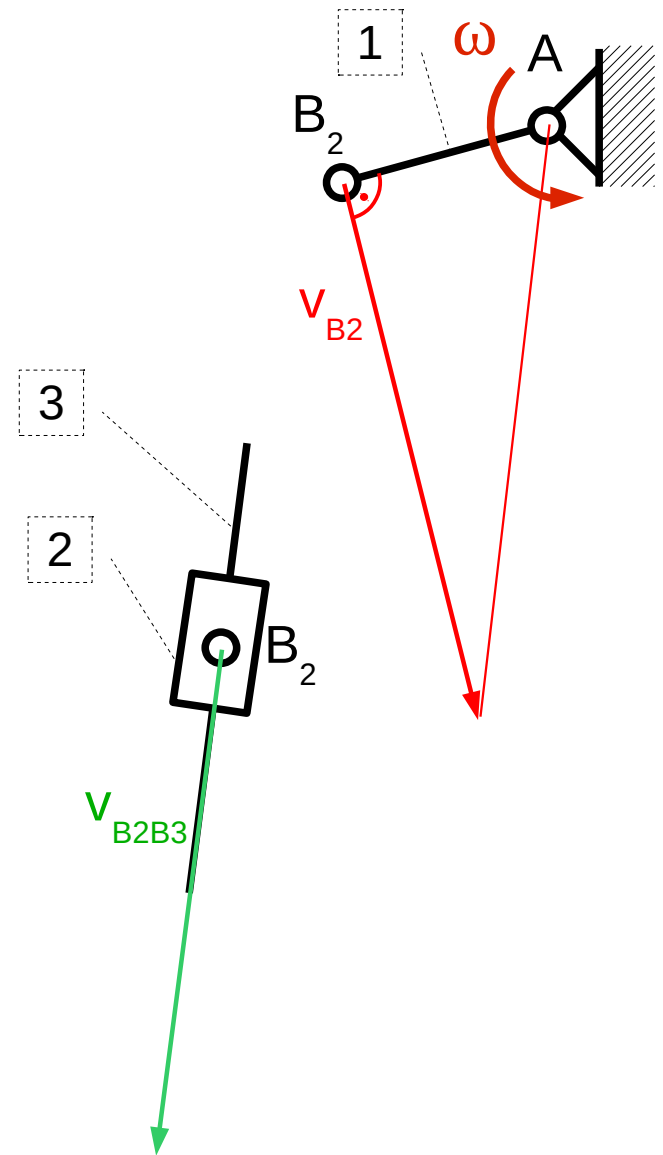
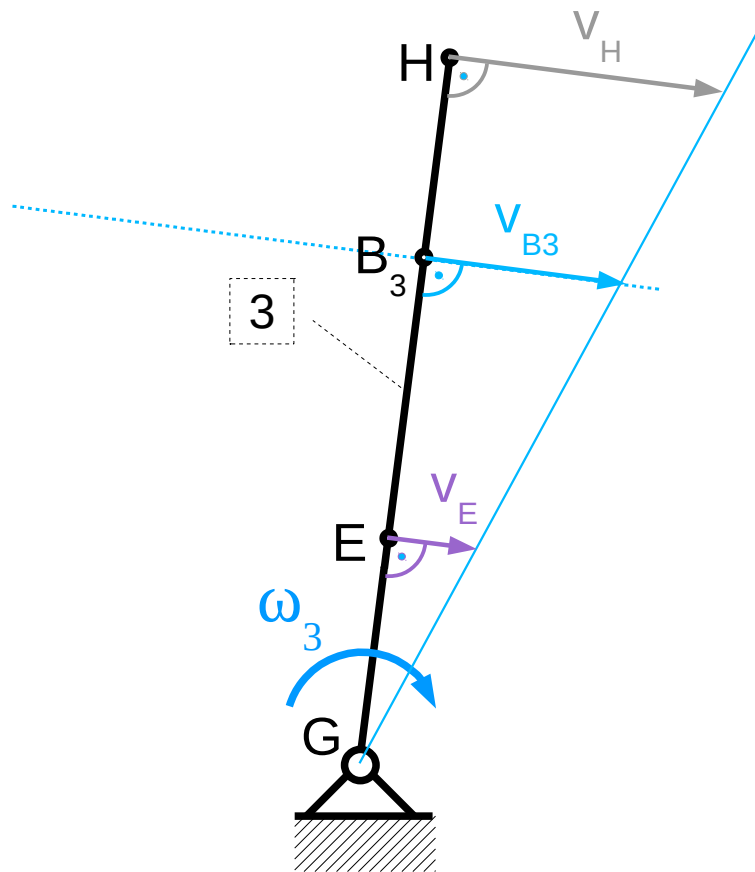
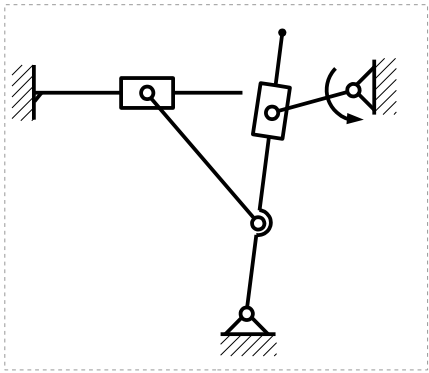

Rozważmy teraz ruch członu 4.

Prędkość punktu F wyznaczymy ze znajomości prędkości punktu E

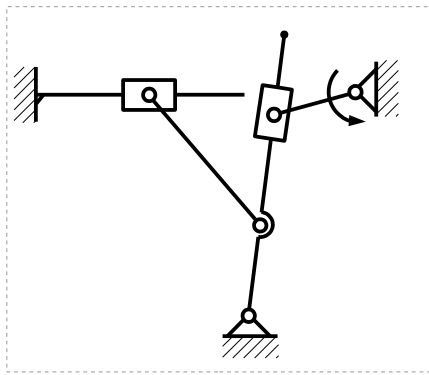

$$V_F = V_E + V_{FE}$$

$$\parallel 6 \perp 3 \perp 4$$

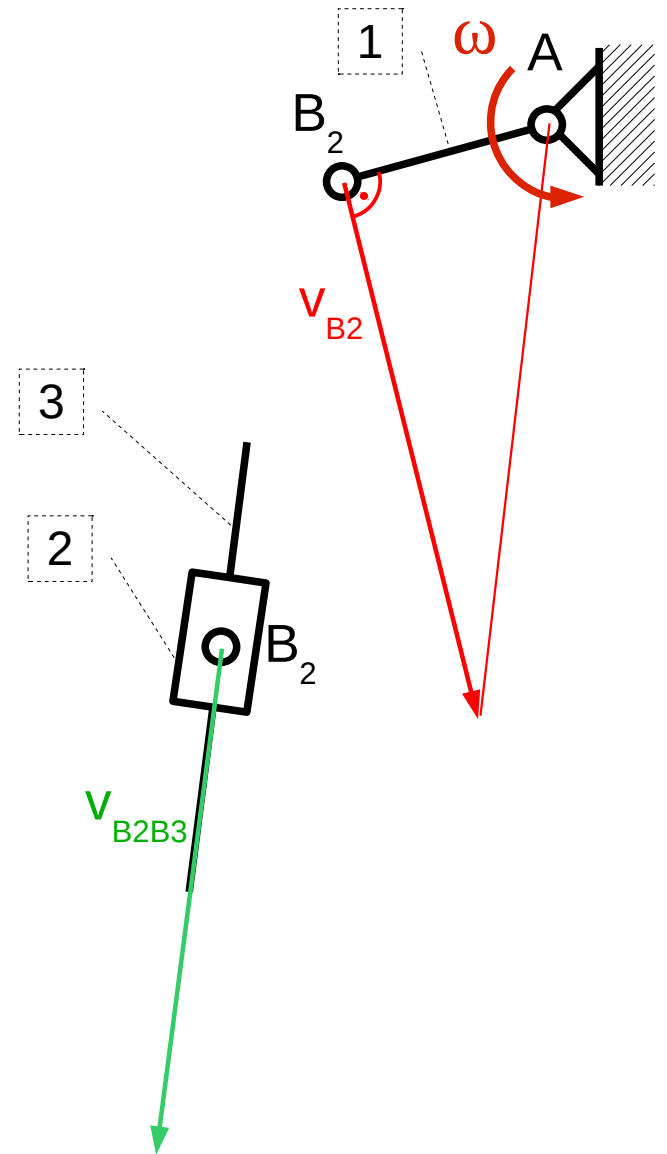
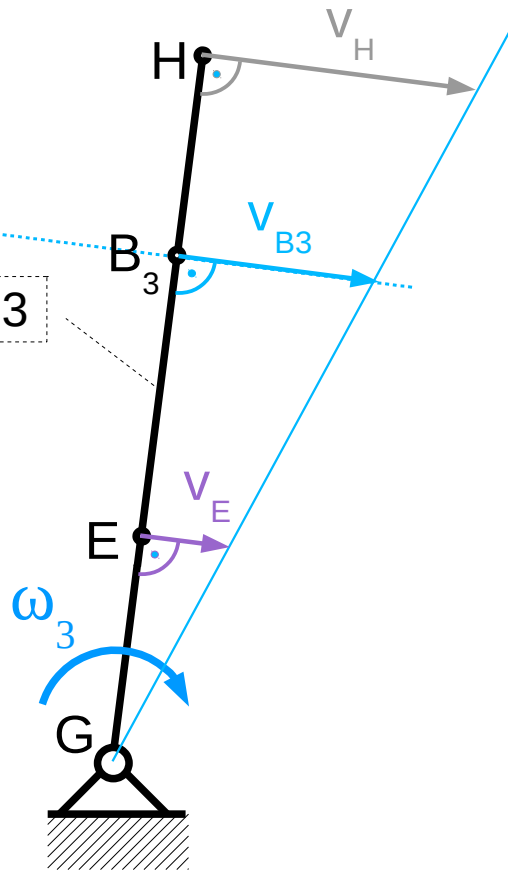
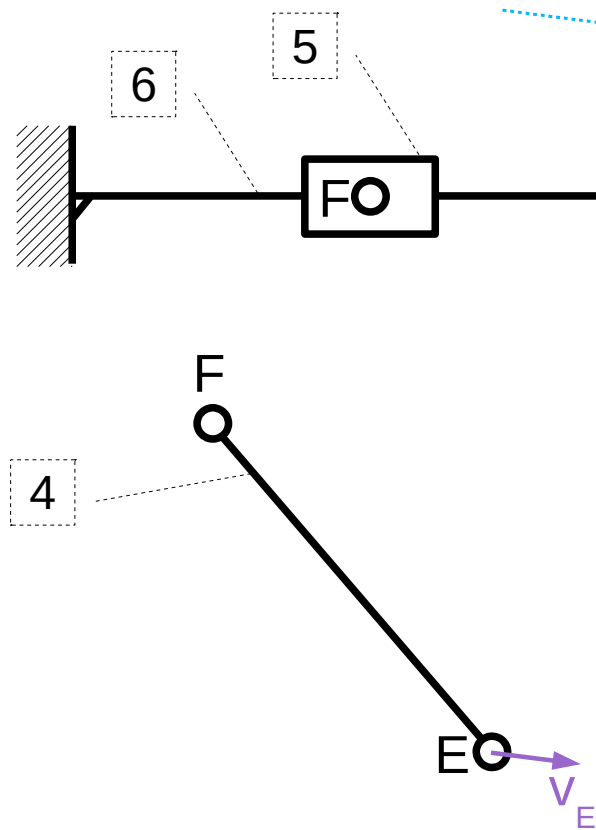

Plan prędkości

$$\frac{V_F}{\parallel 6} = \frac{V_E}{\perp 3} + \frac{V_{FE}}{\perp 4}$$

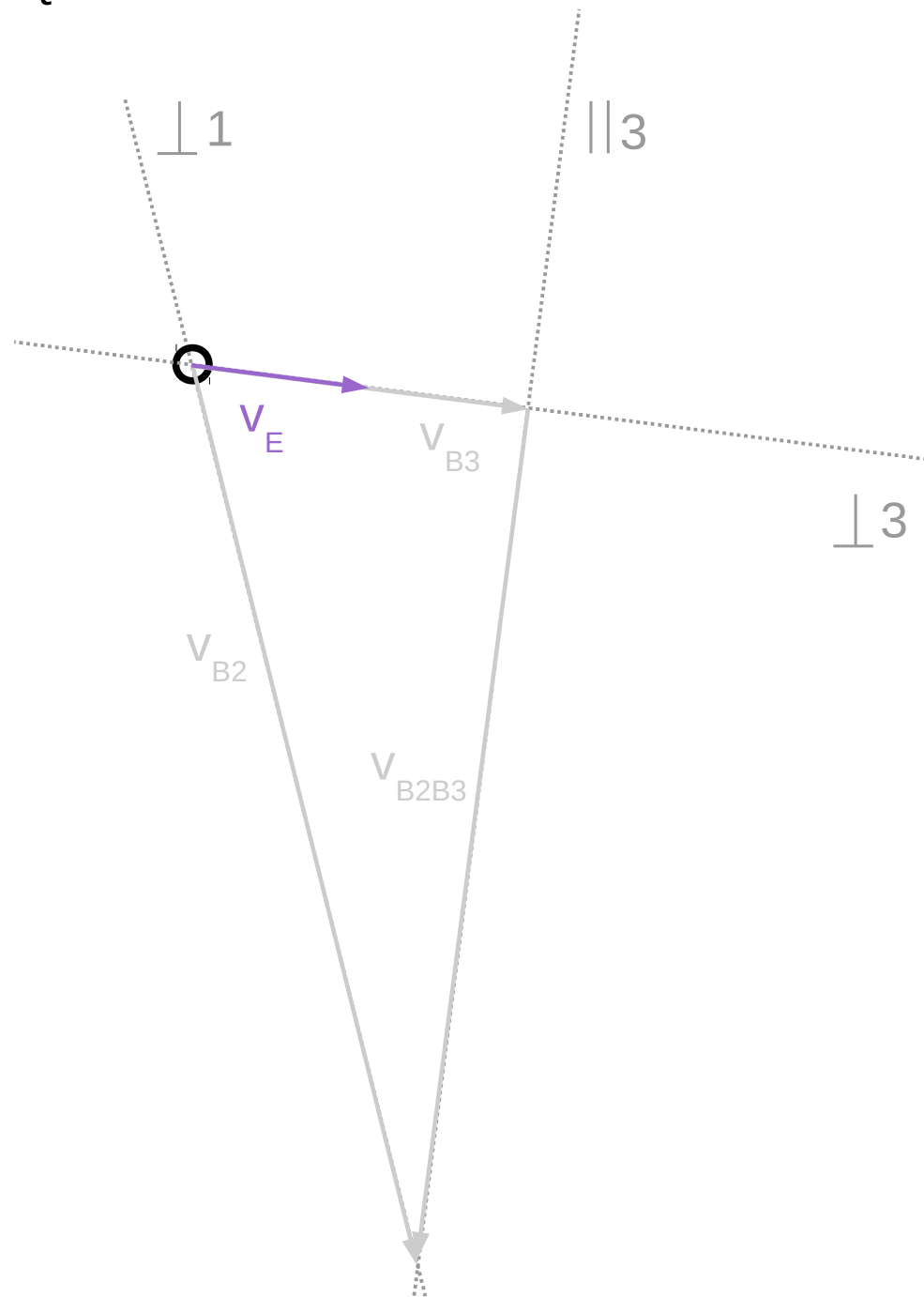

Plan prędkości

$$\frac{v_F}{\parallel 6} = \frac{v_E}{\perp 3} + \frac{v_{FE}}{\perp 4}$$

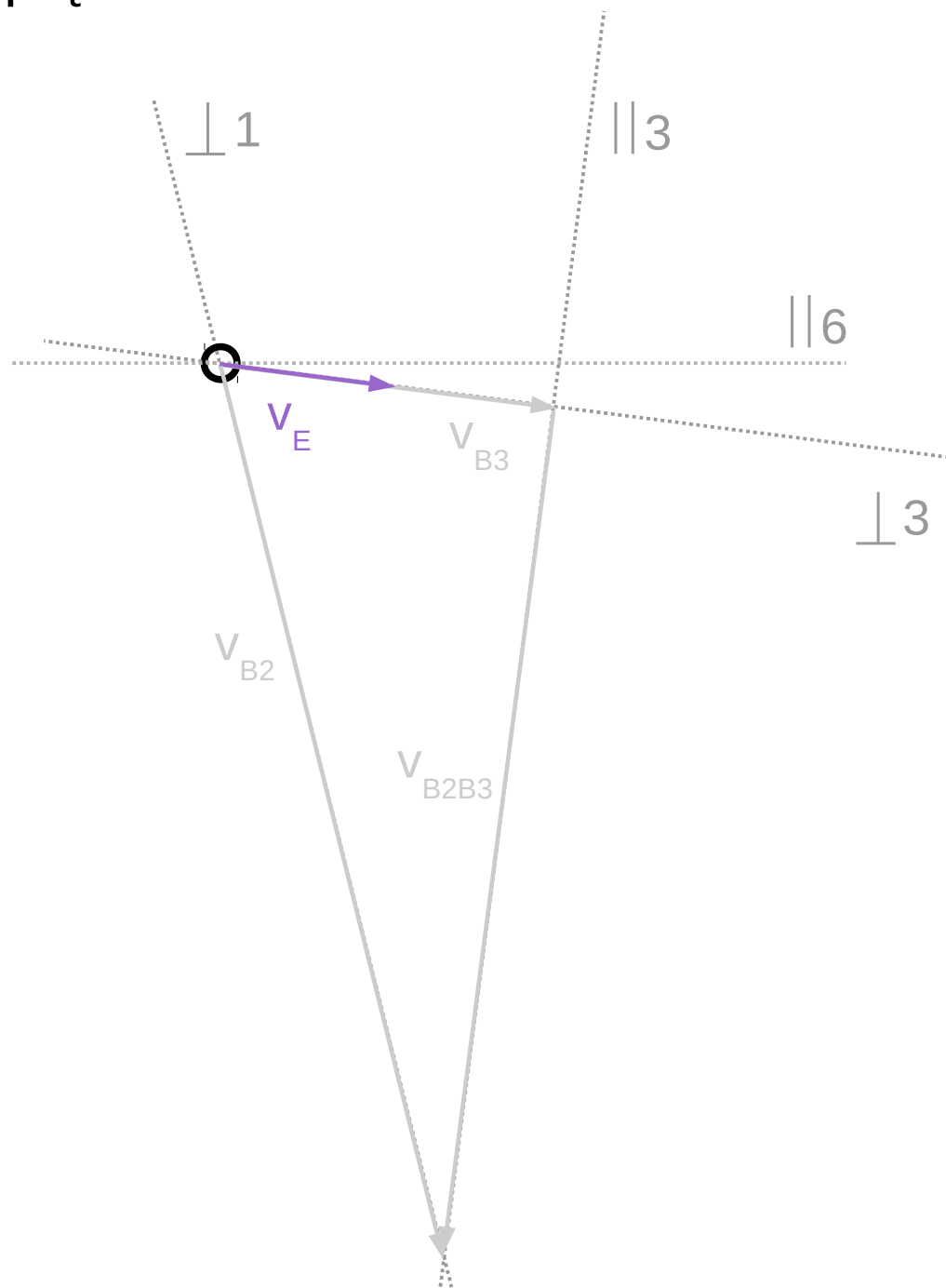

Plan prędkości

$$\frac{v_F}{\parallel 6} = \frac{v_E}{\perp 3} + \frac{v_{FE}}{\perp 4}$$

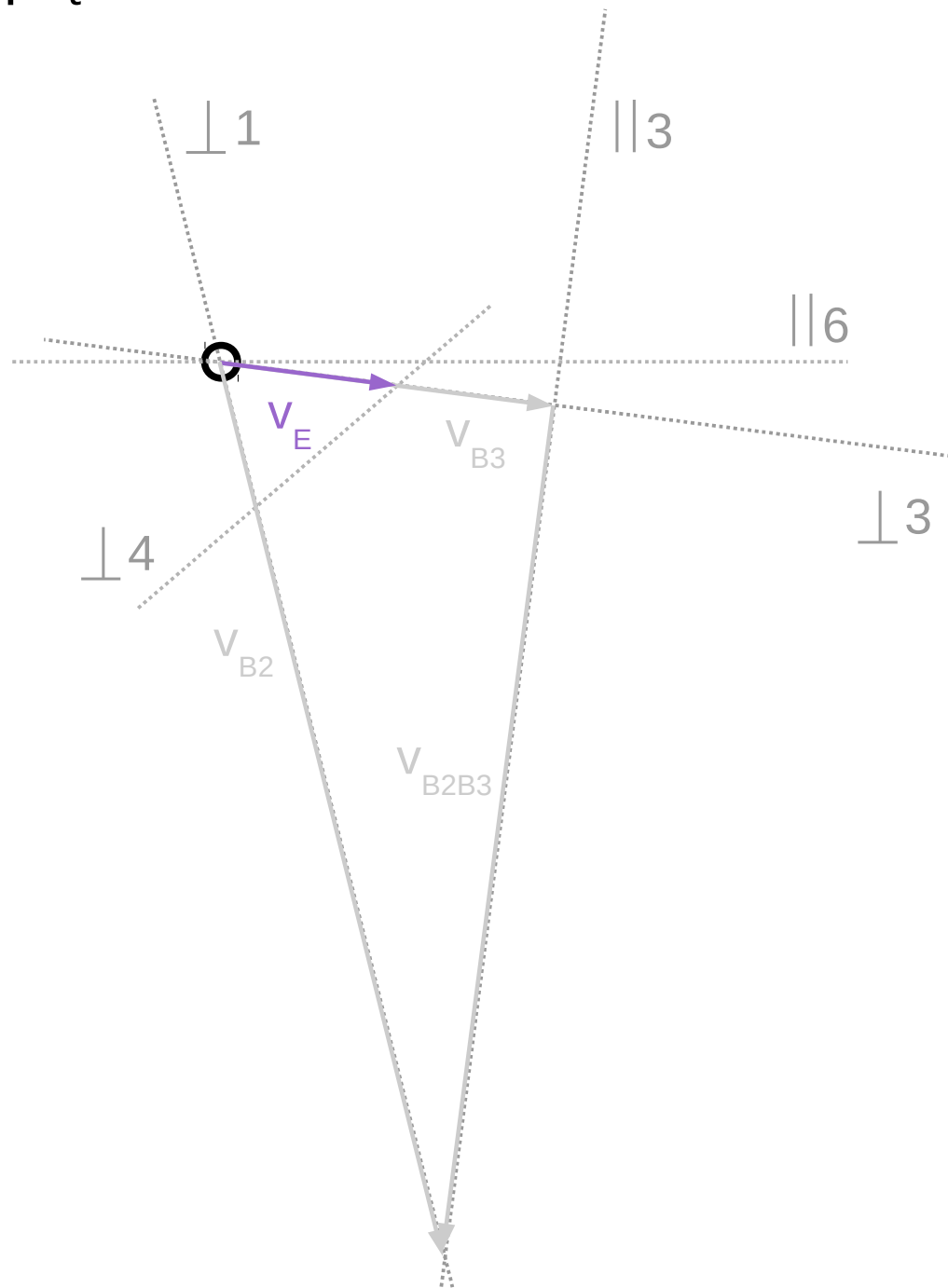

Plan prędkości

$$\frac{v_F}{\parallel 6} = \frac{v_E}{\perp 3} + \frac{v_{FE}}{\perp 4}$$

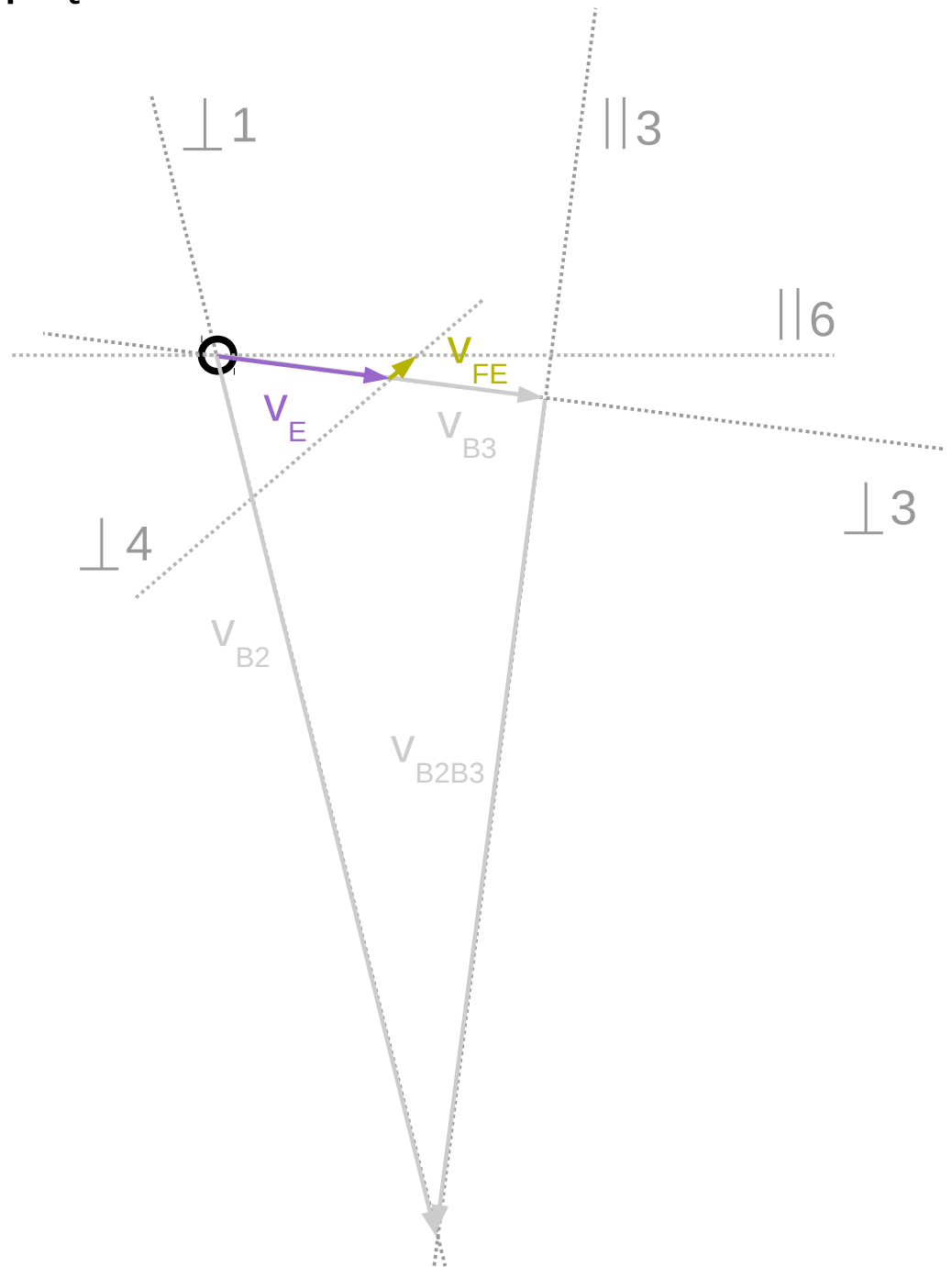

Plan prędkości

$$\frac{v_F}{\parallel 6} = \frac{v_E}{\perp 3} + \frac{v_{FE}}{\perp 4}$$

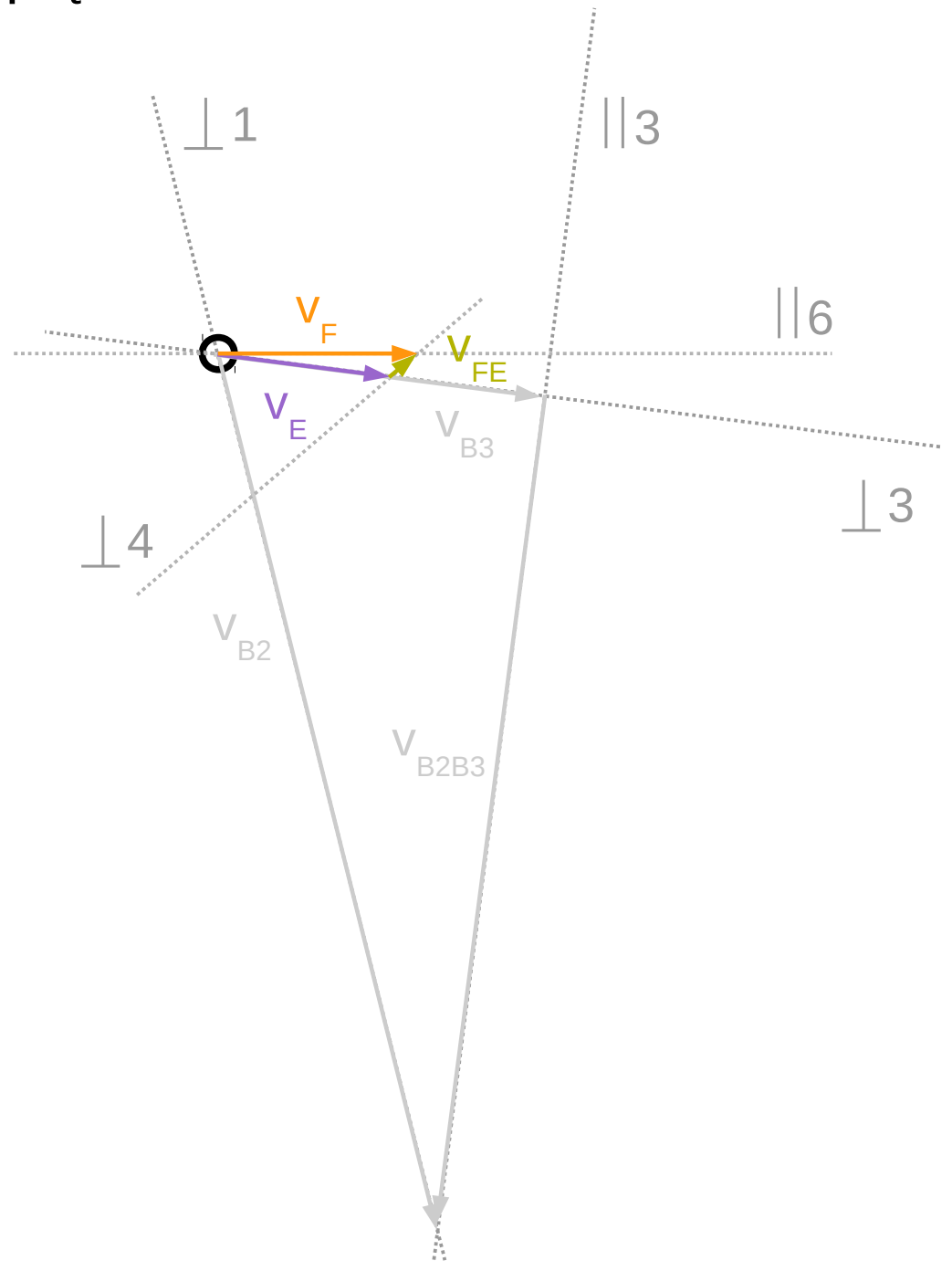

Na zakończenie znajdziemy prędkość kątową elementu 4, jej zwrot wynika ze zwrotu prędkości V_{FE} a jej wartość liczymy

$$\omega_4 = \frac{V_{FE}}{|FE|}$$

$$\omega > \omega_3 > \omega_4$$

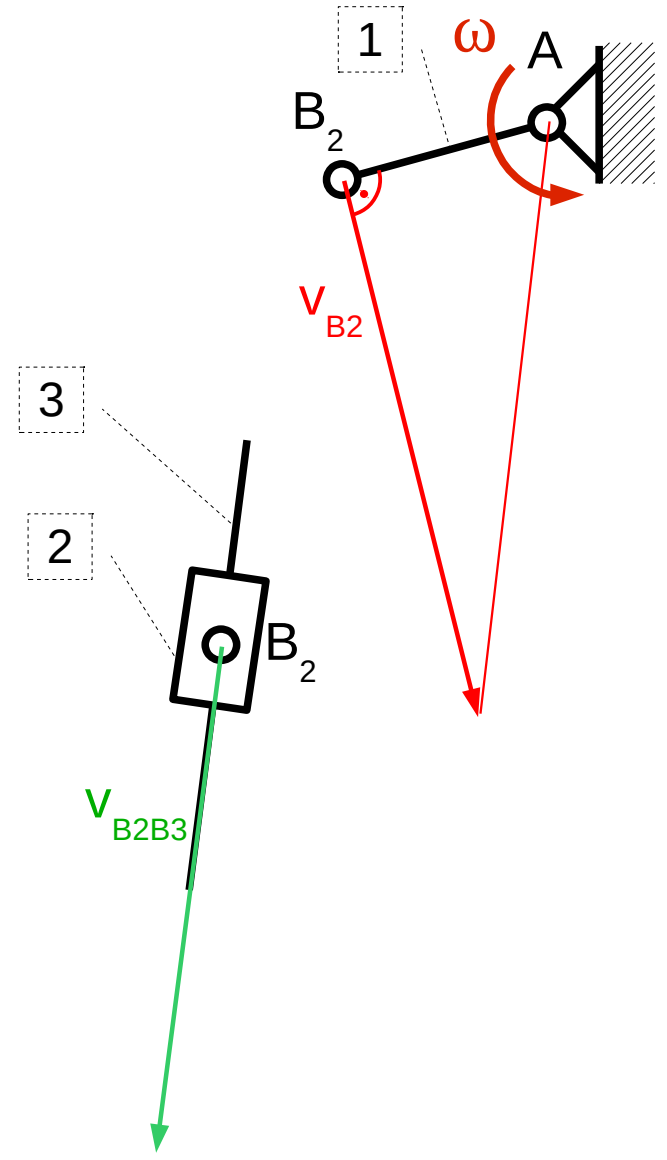
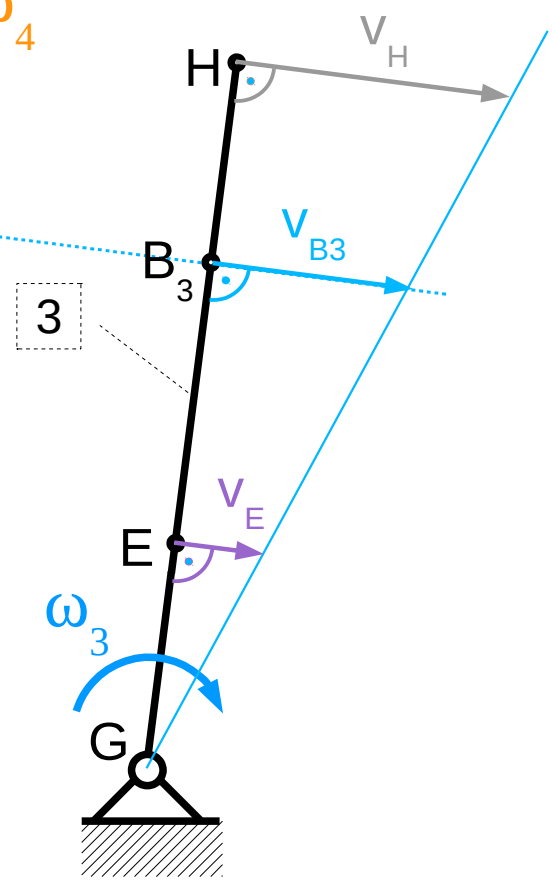
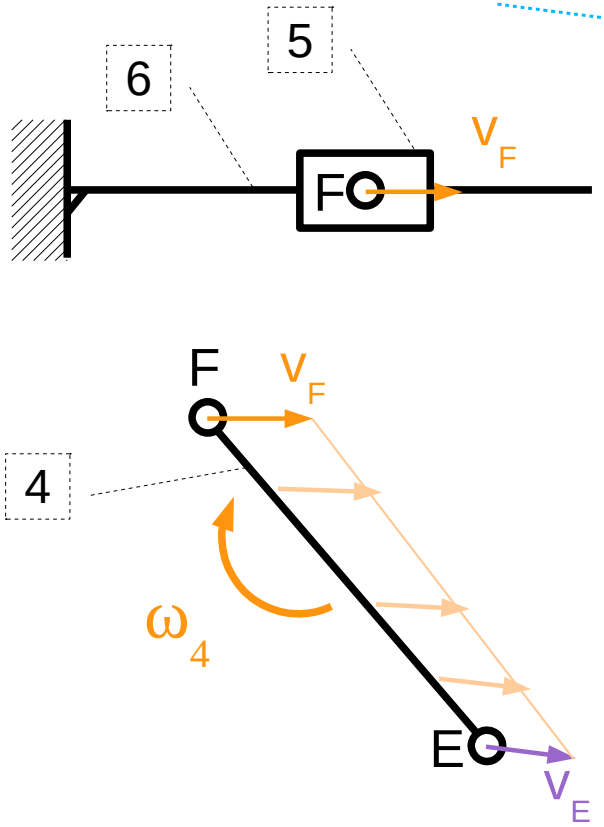
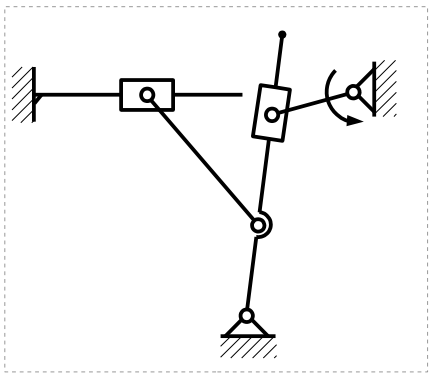

Rozpocznijmy analizę przyspieszeń od członu napędowego

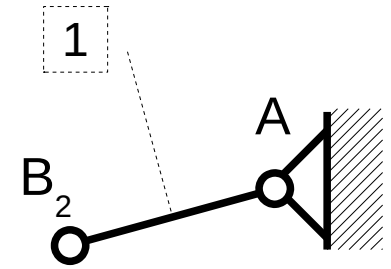
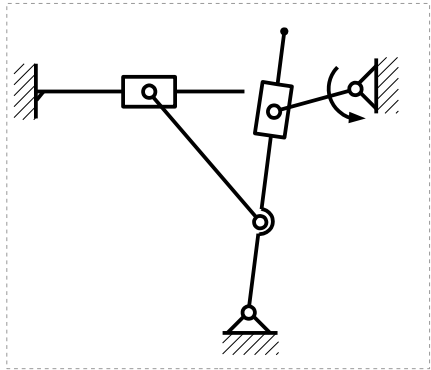

Rozpocznijmy analizę przyspieszeń od członu napędowego

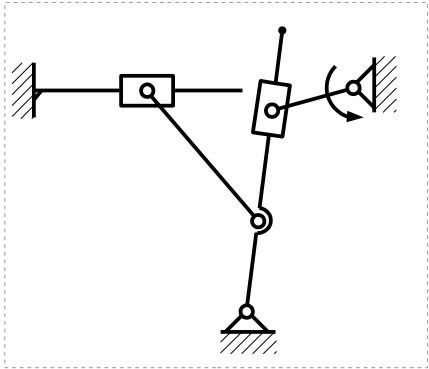

$$p_{B_2} = p_A + p_{B_2A}^n + p_{B_2A}^t$$

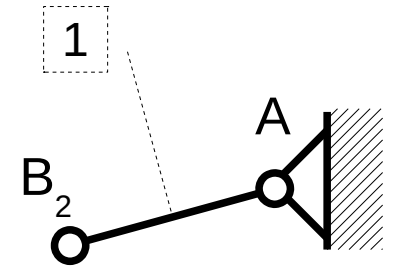

Rozpocznijmy analizę przyspieszeń od członu napędowego

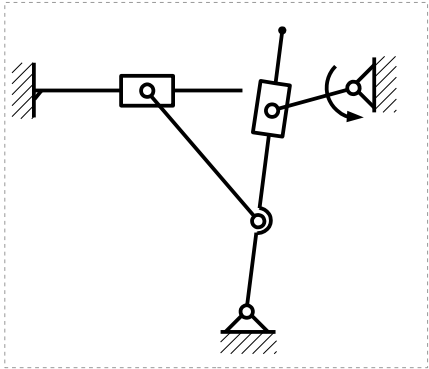

$$\underline{p_{B_2}} = \underline{p_A} + \underline{p_{B_2A}^n} + \underline{p_{B_2A}^t}$$

$$= 0 \quad || 1$$

$$|p_{B_2A}^n| = \omega^2 |B_2A|$$

$$|p_{B_2A}^t| = \varepsilon |B_2A| = 0$$

$$\varepsilon = \frac{d\omega}{dt} = 0$$

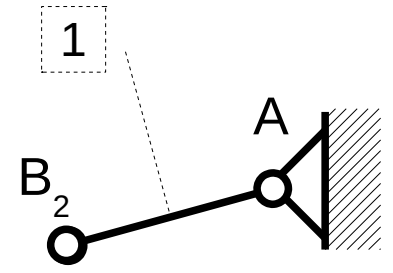

ω z założenia stałe

Rozpocznijmy analizę przyspieszeń od członu napędowego

$$p_{B_2} = \underline{\underline{p_{B_2A}^n}}$$
$$||1$$
$$|p_{B_2A}^n| = \omega^2 |B_2A|$$

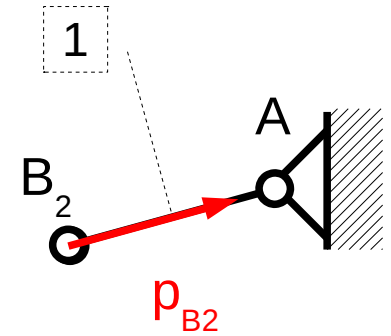

Rozpatrzmy ruch obrotowy elementu trzeciego

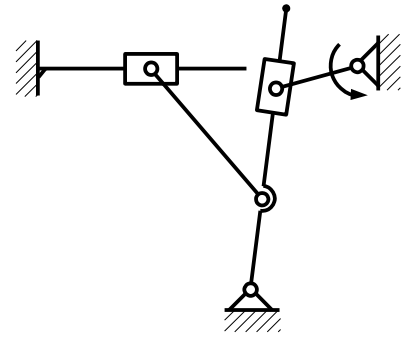

$$p_{B_2} = \underline{\underline{p_{B_2A}^n}}$$

$\parallel 1$

$$|p_{B_2A}^n| = \omega^2 |B_2A|$$

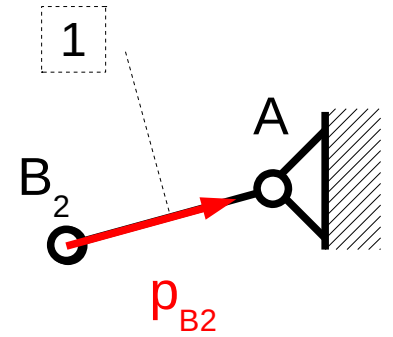

$$p_{B_3} = \underline{\underline{p_G}} + \underline{\underline{p_{B_3G}^n}} + \underline{\underline{p_{B_3G}^t}}$$

$= 0 \quad \parallel 3 \quad \perp 3$

$$|p_{B_3G}^n| = \omega_3^2 |B_3G|$$

z planu prędkości

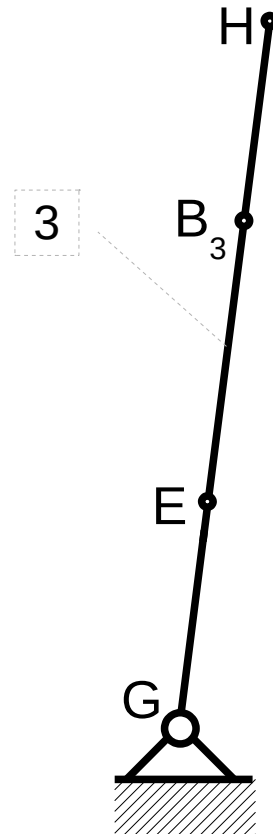

Rozpatrzmy ruch obrotowy elementu trzeciego

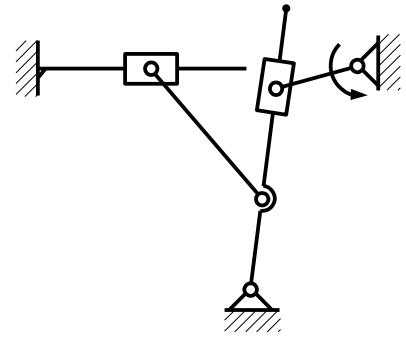

$$p_{B2} = \underline{\underline{p_{B2A}^n}}$$

$\parallel 1$

$$|p_{B2A}^n| = \omega^2 |B_2A|$$

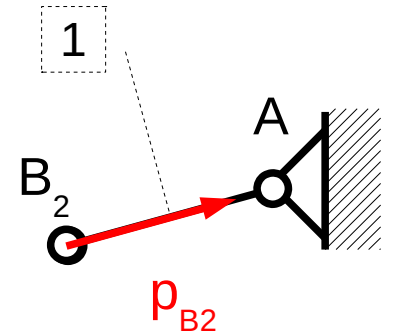

$$p_{B3} = \underline{\underline{p_G}} + \underline{\underline{p_{B3G}^n}} + \underline{\underline{p_{B3G}^t}}$$

$= 0 \quad \parallel 3 \quad \perp 3$

$$|p_{B3G}^n| = \omega_3^2 |B_3G|$$

z planu prędkości

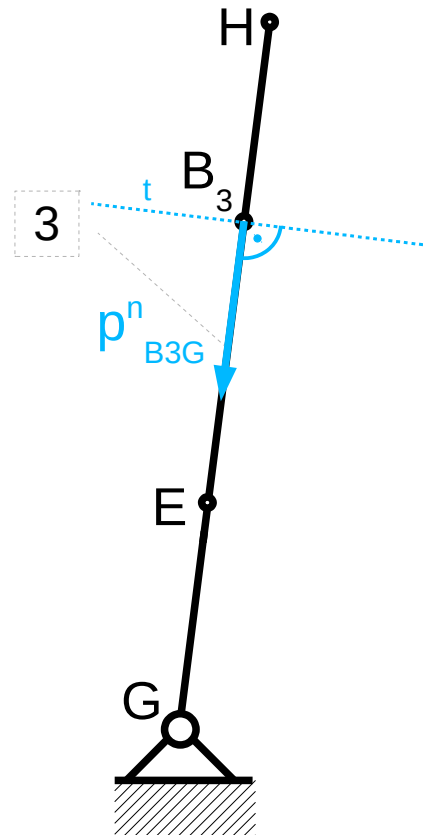

Rozpatrzmy ruch obrotowy elementu trzeciego

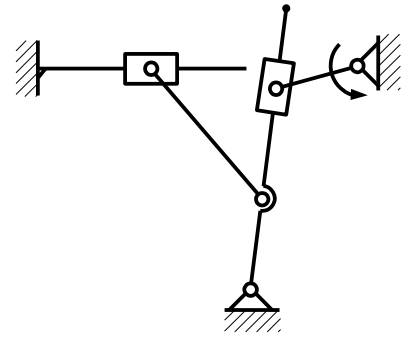

$$p_{B_2} = \underline{\underline{p_{B_2A}^n}}$$

$\parallel 1$

$$|p_{B_2A}^n| = \omega^2 |B_2A|$$

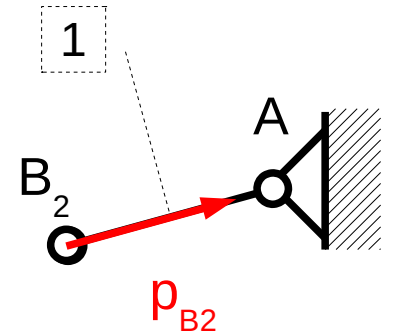

$$p_{B_3} = \underline{\underline{p_{B_3G}^n}} + \underline{\underline{p_{B_3G}^t}}$$

$\parallel 3 \quad \perp 3$

$$|p_{B_3G}^n| = \omega_3^2 |B_3G|$$

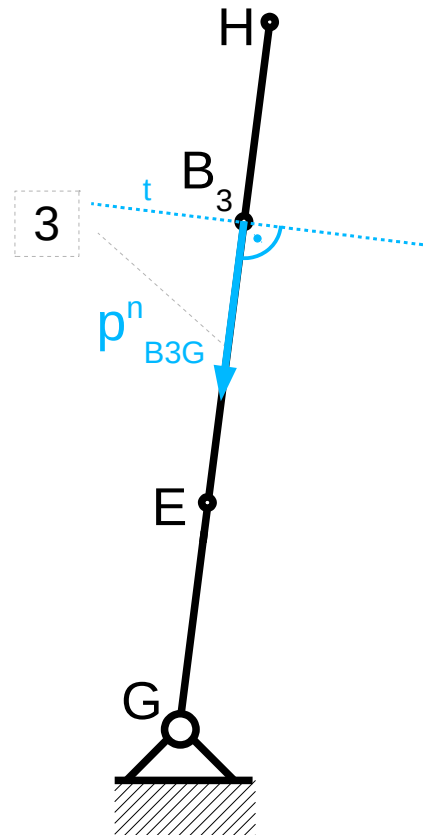

Rozpatrzmy ruch względny elementów 2 i 3

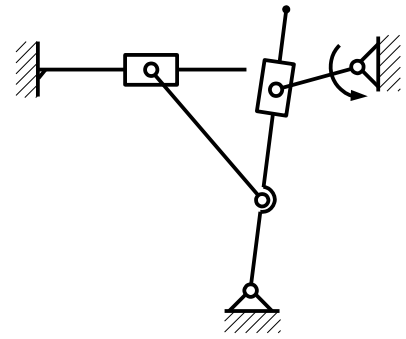

$$p_{B_2} = \underline{\underline{p_{B_2A}^n}}$$

$$\parallel 1$$

$$|p_{B_2A}^n| = \omega^2 |B_2A|$$

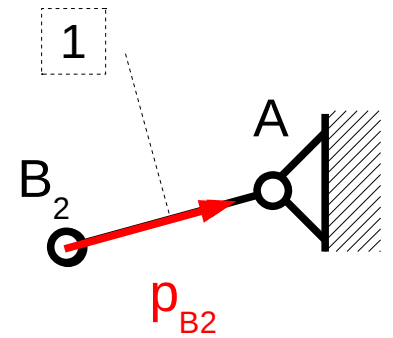

$$p_{B_3} = \underline{\underline{p_{B_3G}^n}} + \underline{\underline{p_{B_3G}^t}}$$

$\parallel 3 \quad \perp 3$

$$|p_{B_3G}^n| = \omega_3^2 |B_3G|$$

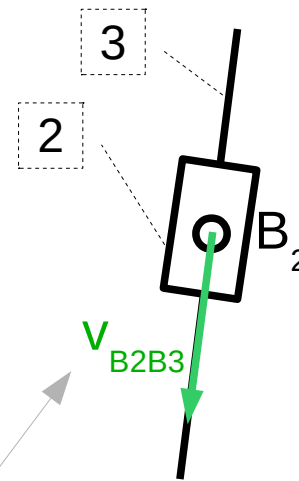
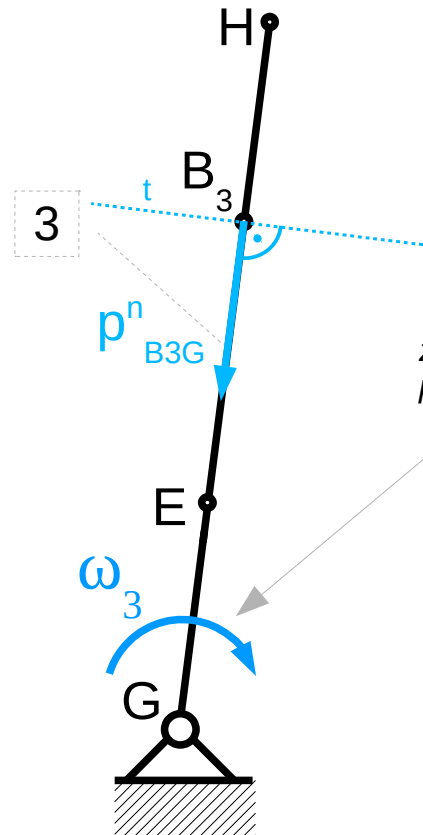

z planu prędkości

Rozpatrzmy ruch względny elementów 2 i 3

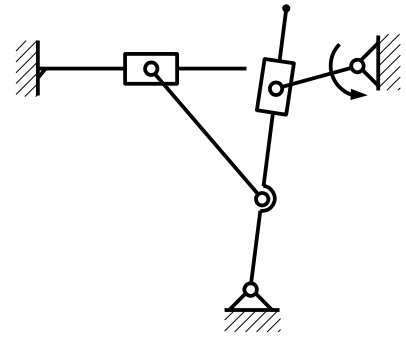

$$p_{B2} = \underline{\underline{p_{B2A}^n}}$$

$$\parallel 1$$

$$|p_{B2A}^n| = \omega^2 |B_2A|$$

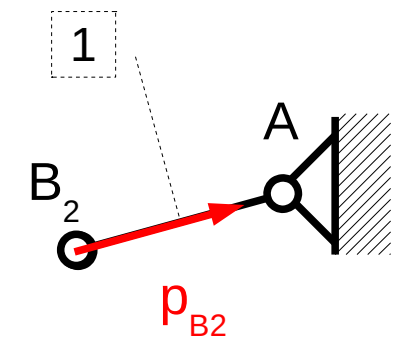

$$p_{B3} = \underline{\underline{p_{B3G}^n}} + \underline{\underline{p_{B3G}^t}}$$

$\parallel 3 \quad \perp 3$

$$|p_{B3G}^n| = \omega_3^2 |B_3G|$$

RUCH UNOSZENIA: ruch elementu 3
RUCH WZGLĘDNY: ruch elementu 2
wzdłuż elementu 3

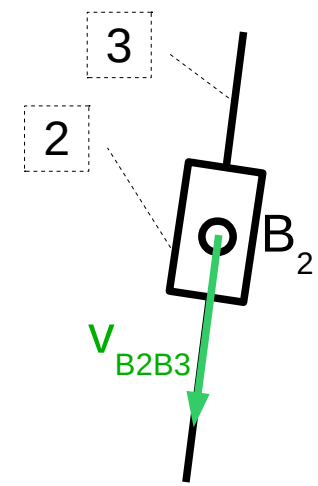
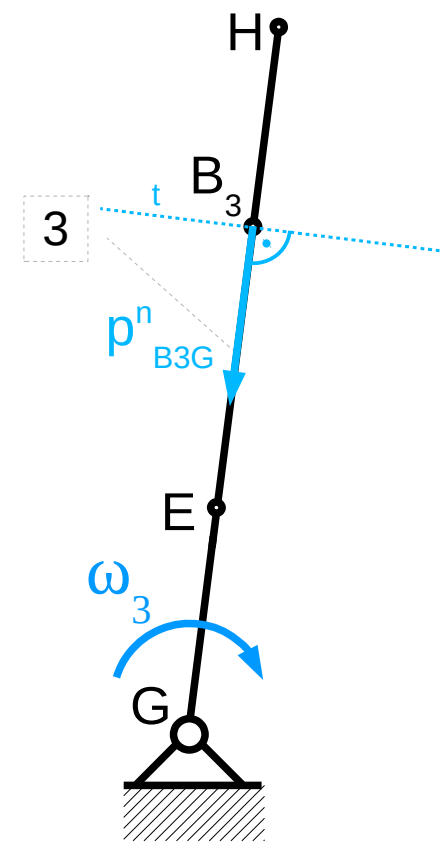

Rozpatrzmy ruch względny elementów 2 i 3

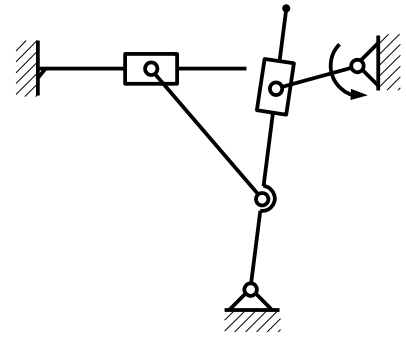

$$p_{B2} = \underline{\underline{p_{B2A}^n}}$$

$$\parallel 1$$

$$|p_{B2A}^n| = \omega^2 |B_2A|$$

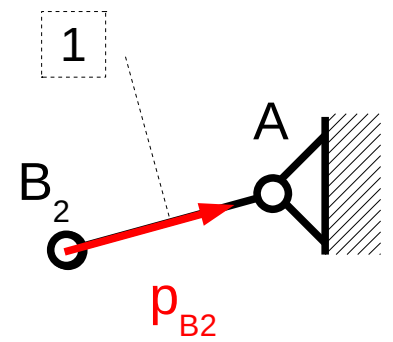

$$p_{B3} = \underline{\underline{p_{B3G}^n}} + \underline{\underline{p_{B3G}^t}}$$

$\parallel 3 \quad \perp 3$

$$|p_{B3G}^n| = \omega_3^2 |B_3G|$$

RUCH UNOSZENIA: ruch elementu 3
RUCH WZGLĘDNY: ruch elementu 2
wzdłuż elementu 3

RÓWNANIE RUCHU WZGLĘDNEGO:

$$p_{B2} = p_{B3}^u + p^w + p^c$$

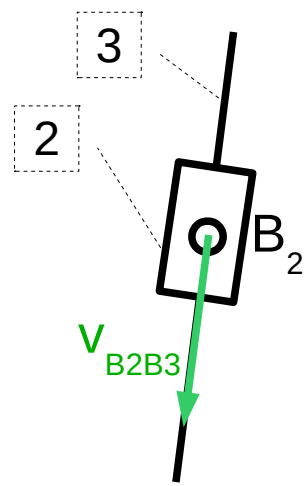
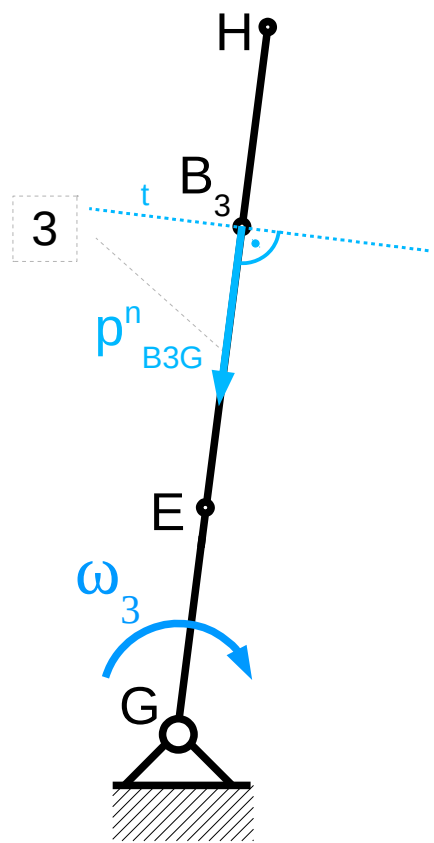

Rozpatrzmy ruch względny elementów 2 i 3

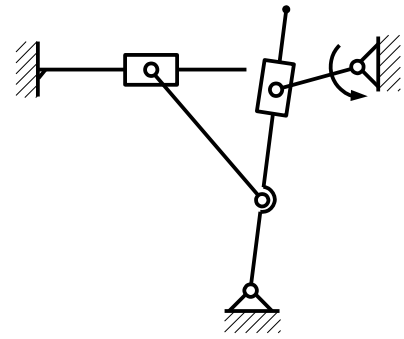

$$p_{B_2} = \underline{\underline{p_{B_2A}^n}}$$

$$\parallel 1$$

$$|p_{B_2A}^n| = \omega^2 |B_2A|$$

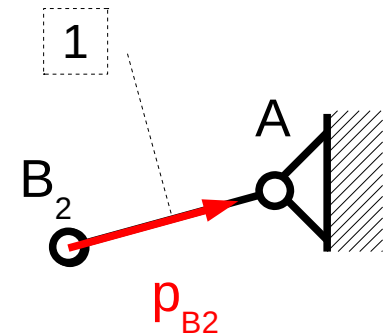

$$p_{B_3} = \underline{\underline{p_{B_3G}^n}} + \underline{\underline{p_{B_3G}^t}}$$

$\parallel 3 \quad \perp 3$

$$|p_{B_3G}^n| = \omega_3^2 |B_3G|$$

RUCH UNOSZENIA: ruch elementu 3
RUCH WZGLĘDNY: ruch elementu 2
wzdłuż elementu 3

RÓWNANIE RUCHU WZGLĘDNEGO:

$$p_{B_2} = p_{B_3}^u + p_{B_3}^w + p^c$$

$$p_{B_2A}^n = p_{B_3G}^n + p_{B_3G}^t + p_{B_2B_3}^w + p^c$$

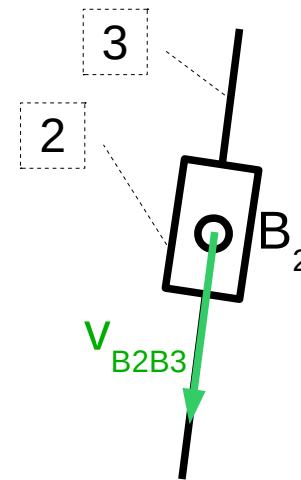
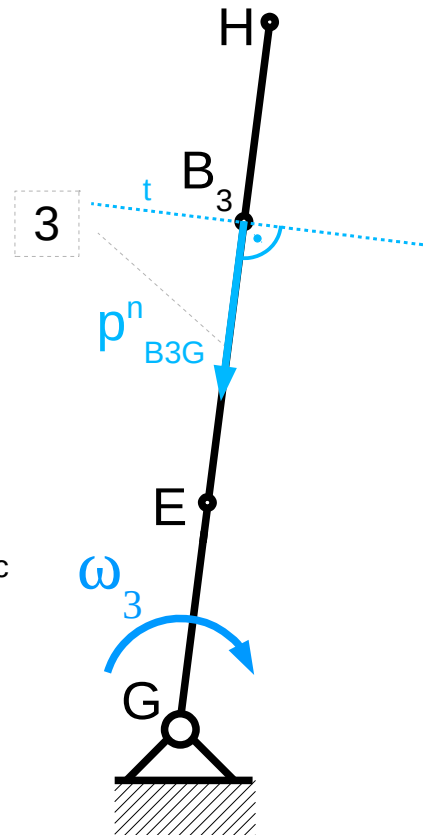

Rozpatrzmy ruch względny elementów 2 i 3

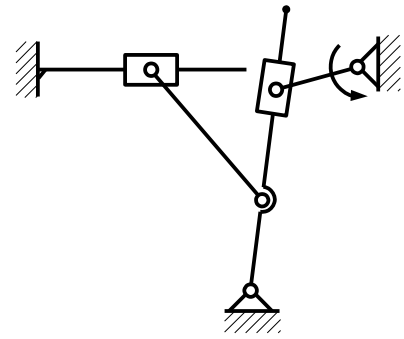

$$p_{B2} = \underline{\underline{p_{B2A}^n}}$$

$$\parallel 1$$

$$|p_{B2A}^n| = \omega^2 |B_2A|$$

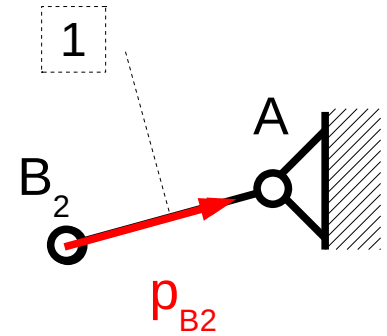

$$p_{B3} = \underline{\underline{p_{B3G}^n}} + \underline{\underline{p_{B3G}^t}}$$

$\parallel 3 \quad \perp 3$

$$|p_{B3G}^n| = \omega_3^2 |B_3G|$$

RUCH UNOSZENIA: ruch elementu 3
RUCH WZGLĘDNY: ruch elementu 2
wzdłuż elementu 3

RÓWNANIE RUCHU WZGLĘDNEGO:

$$p_{B2} = p_{B3}^u + p_{B3}^w + p^c$$

$$\underline{\underline{p_{B2A}^n}} = \underline{\underline{p_{B3G}^n}} + \underline{\underline{p_{B3G}^t}} + \underline{\underline{p_{B2B3}^w}} + p^c$$

$\parallel 1 \quad \parallel 3 \quad \perp 3 \quad \parallel 3$

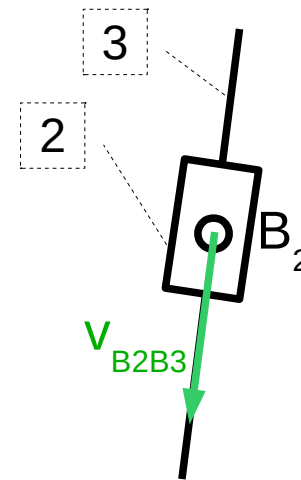
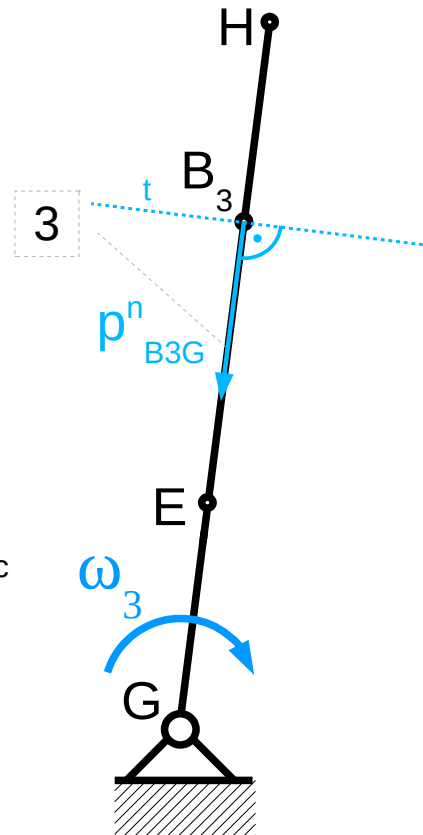

Przyspieszenie Coriolisa

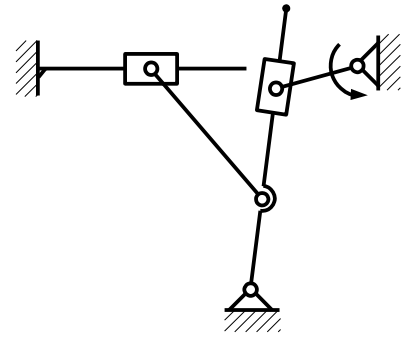

$$p_{B_2} = p_{B_3}^u + p_{B_3}^w + p^c$$

$$\overline{\overline{p_{B_2A}^n}} = \overline{\overline{p_{B_3G}^n}} + \overline{\overline{p_{B_3G}^t}} + \overline{\overline{p_{B_2B_3}^w}} + p^c$$

$\parallel 1$ $\parallel 3$ $\perp 3$ $\parallel 3$

$$p^c = 2\omega_3 \times V_{B_2B_3}$$

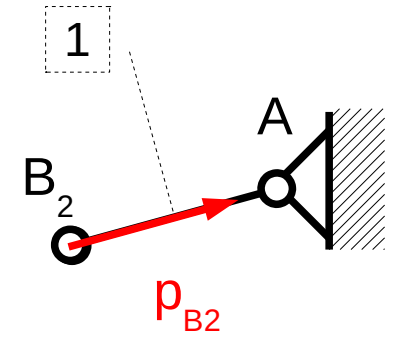
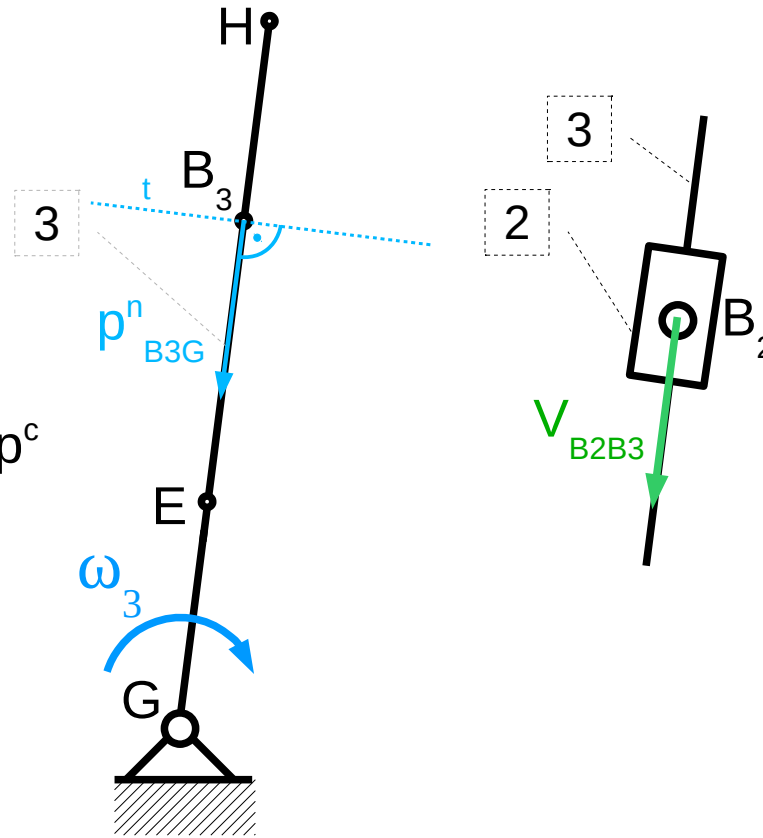

Przyspieszenie Coriolisa

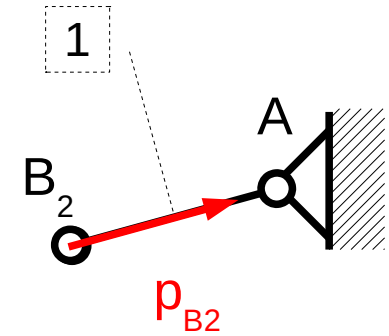
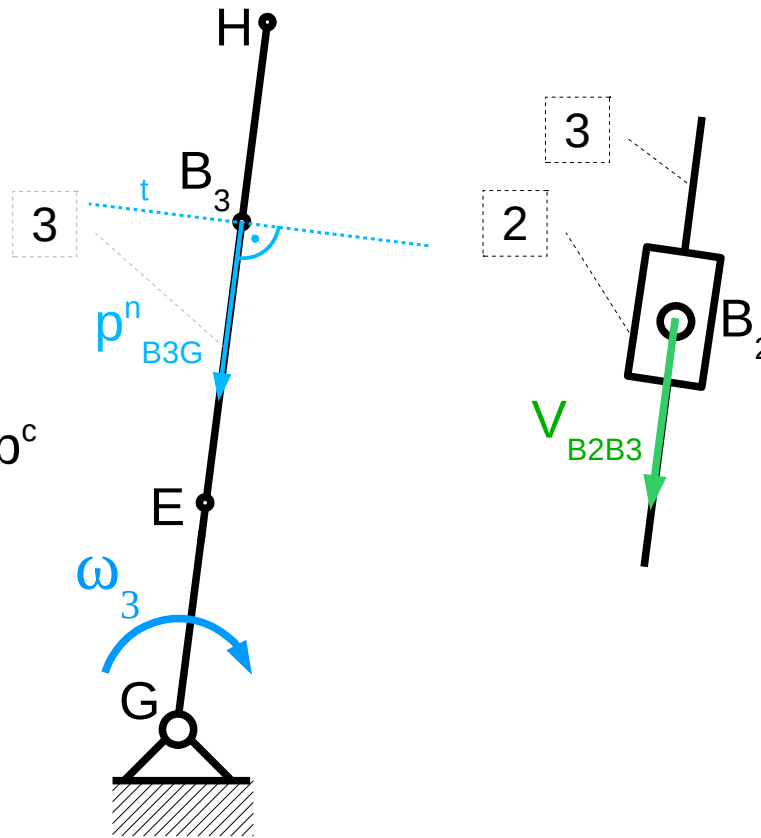
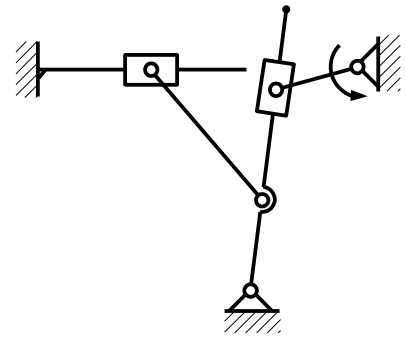

$$p_{B2} = p_{B3}^u + p_{B3}^w + p^c$$

$$\overline{\overline{p_{B2A}^n}} = \overline{\overline{p_{B3G}^n}} + \overline{\overline{p_{B3G}^t}} + \overline{\overline{p_{B2B3}^w}} + p^c$$

$\parallel 1 \quad \parallel 3 \quad \perp 3 \quad \parallel 3$

$$p^c = 2\omega_3 \times V_{B2B3}$$

$$|p^c| = 2|\omega_3| |V_{B2B3}| \sin(\angle(\omega_3, V_{B2B3}))$$

Przyspieszenie Coriolisa

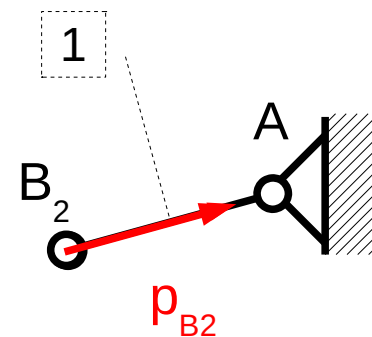
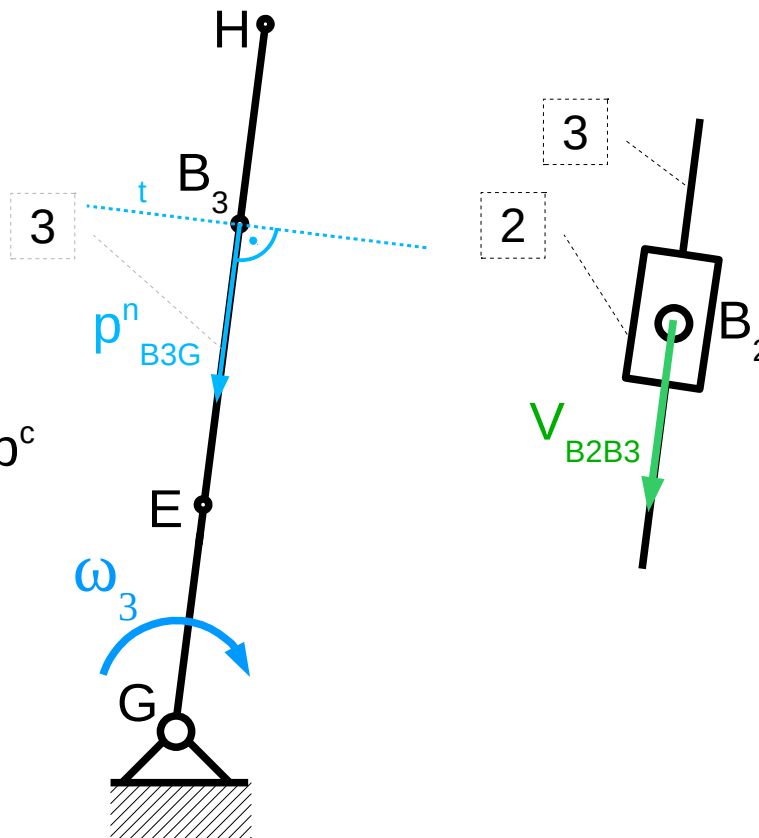
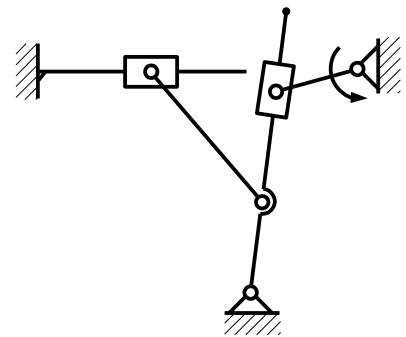

$$\underline{p}_{B2} = \underline{p}_{B3}^u + \underline{p}_{B3}^w + \underline{p}^c$$

$$\underline{p}_{B2A}^n = \underline{p}_{B3G}^n + \underline{p}_{B3G}^t + \underline{p}_{B2B3}^w + \underline{p}^c$$

$\parallel 1$ $\parallel 3$ $\perp 3$ $\parallel 3$

$$\underline{p}^c = 2\omega_3 \times V_{B2B3}$$

$$|p^c| = 2|\omega_3| |V_{B2B3}| \sin(\angle(\omega_3, V_{B2B3}))$$

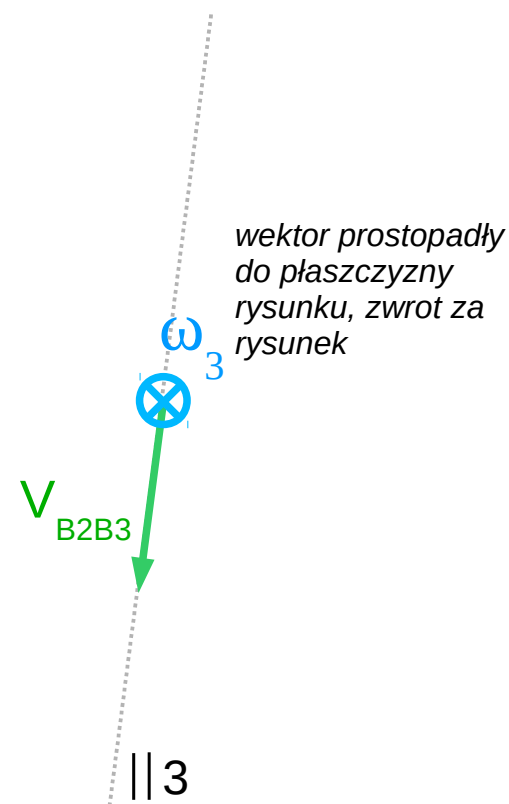

Przyspieszenie Coriolisa

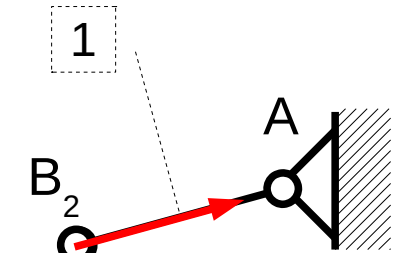
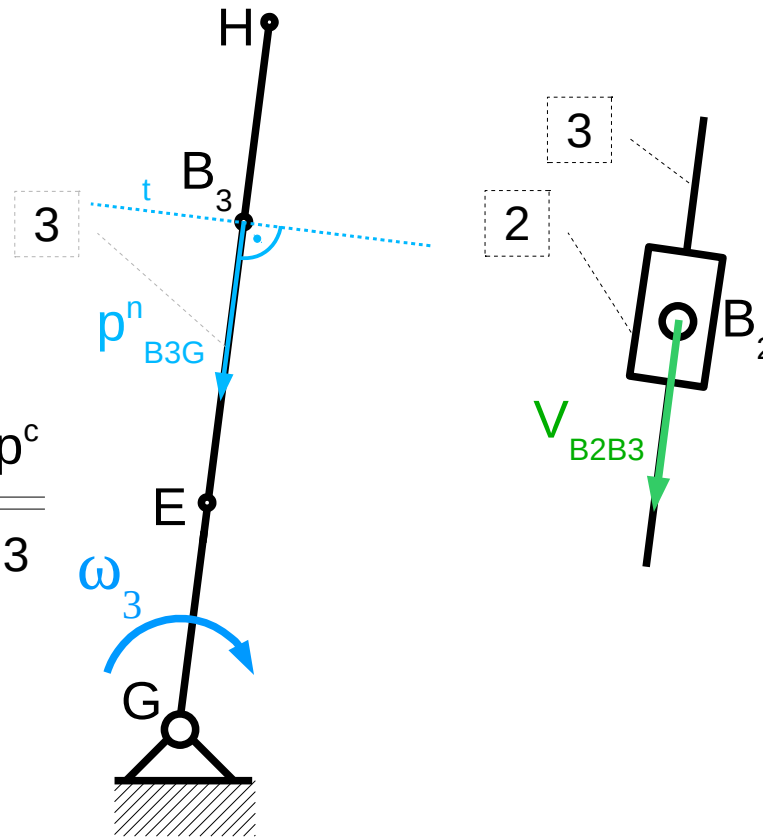
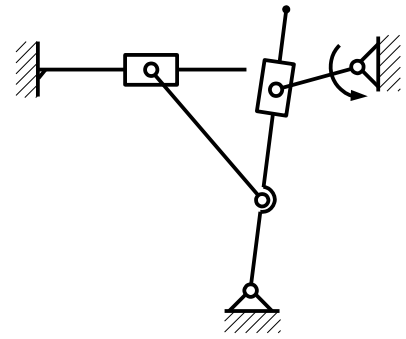

$$p_{B2} = p_{B3}^u + p_{B3}^w + p^c$$

$$\overline{\overline{p_{B2A}^n}} = \overline{\overline{p_{B3G}^n}} + \overline{\perp 3 p_{B3G}^t} + \overline{\overline{p_{B2B3}^w}} + \overline{\perp 3 p^c}$$

||1 ||3 ⊥3 ||3 ⊥3

$$p^c = 2\omega_3 \times V_{B2B3}$$

$$|p^c| = 2|\omega_3| |V_{B2B3}| \sin(\angle(\omega_3, V_{B2B3})) = 2|\omega_3| |V_{B2B3}|$$

kąt prosty

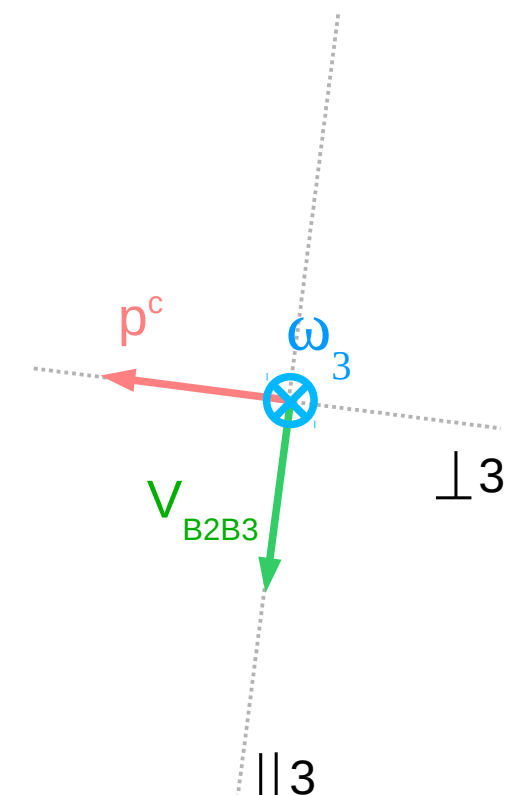

Plan przyspieszeń

$$\begin{array}{ccccccccc} \underline{\underline{p^n}}_{B2A} & = & \underline{\underline{p^n}}_{B3G} & + & \underline{\underline{p^t}}_{B3G} & + & \underline{\underline{p^w}}_{B2B3} & + & \underline{\underline{p^c}} \\ ||1 & & ||3 & & \perp 3 & & ||3 & & \perp 3 \end{array}$$

$$\begin{array}{ccccccccc} \underline{\underline{p^n}}_{B2A} & - & \underline{\underline{p^c}} & - & \underline{\underline{p^w}}_{B2B3} & = & \underline{\underline{p^n}}_{B3G} & + & \underline{\underline{p^t}}_{B3G} \\ ||1 & & \perp 3 & & || 3 & & || 3 & & \perp 3 \end{array}$$

Plan przyspieszeń

$$\begin{array}{ccccc} \underline{\underline{p^n}}_{B2A} & - & \underline{\underline{p^c}} & - & \underline{\underline{p^w}}_{B2B3} & = & \underline{\underline{p^n}}_{B3G} & + & \underline{\underline{p^t}}_{B3G} \\ ||1 & & \perp 3 & & || 3 & & || 3 & & \perp 3 \end{array}$$

○

Plan przyspieszeń

$$\frac{\underline{\underline{p^n_{B2A}}}}{\parallel 1} - \frac{\underline{\underline{p^c}}}{\perp 3} - \frac{\underline{\underline{p^w_{B2B3}}}}{\parallel 3} = \frac{\underline{\underline{p^n_{B3G}}}}{\parallel 3} + \frac{\underline{\underline{p^t_{B3G}}}}{\perp 3}$$

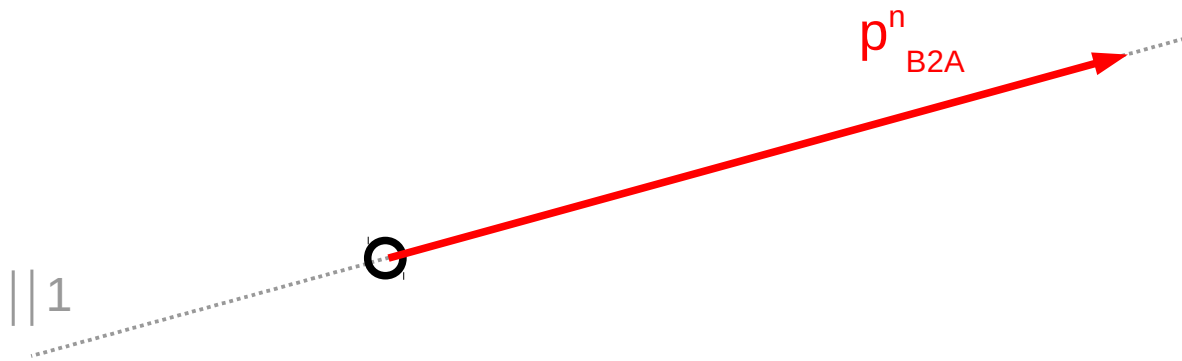

Plan przyspieszeń

$$\frac{\underline{\underline{p^n_{B2A}}}}{\parallel 1} - \frac{\underline{\underline{-p^c}}}{\perp 3} - \frac{p^w_{B2B3}}{\parallel 3} = \frac{\underline{\underline{p^n_{B3G}}}}{\parallel 3} + \frac{p^t_{B3G}}{\perp 3}$$

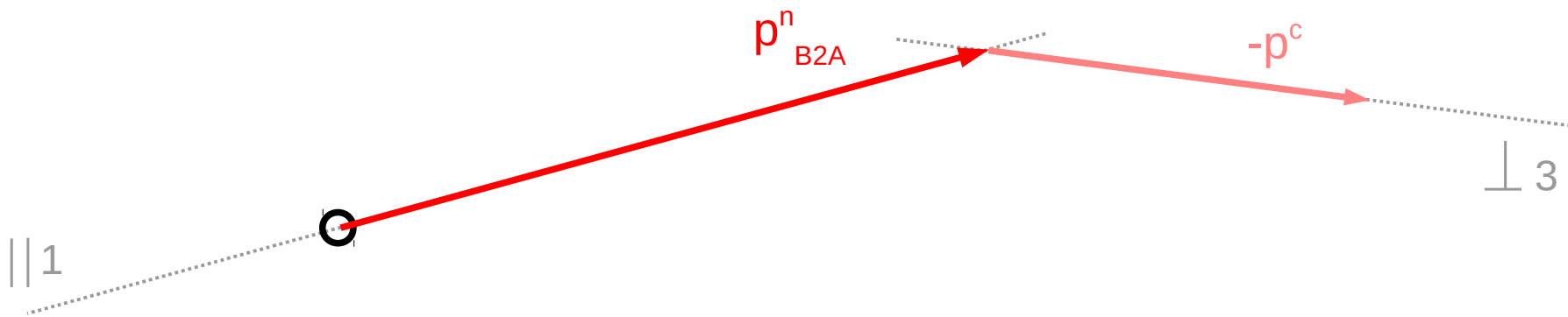

Plan przyspieszeń

$$\frac{\underline{\underline{p^n_{B2A}}}}{\parallel 1} - \frac{\underline{\underline{-p^c}}}{\perp 3} - \frac{-p^w_{B2B3}}{\parallel 3} = \frac{\underline{\underline{p^n_{B3G}}}}{\parallel 3} + \frac{\underline{\underline{p^t_{B3G}}}}{\perp 3}$$

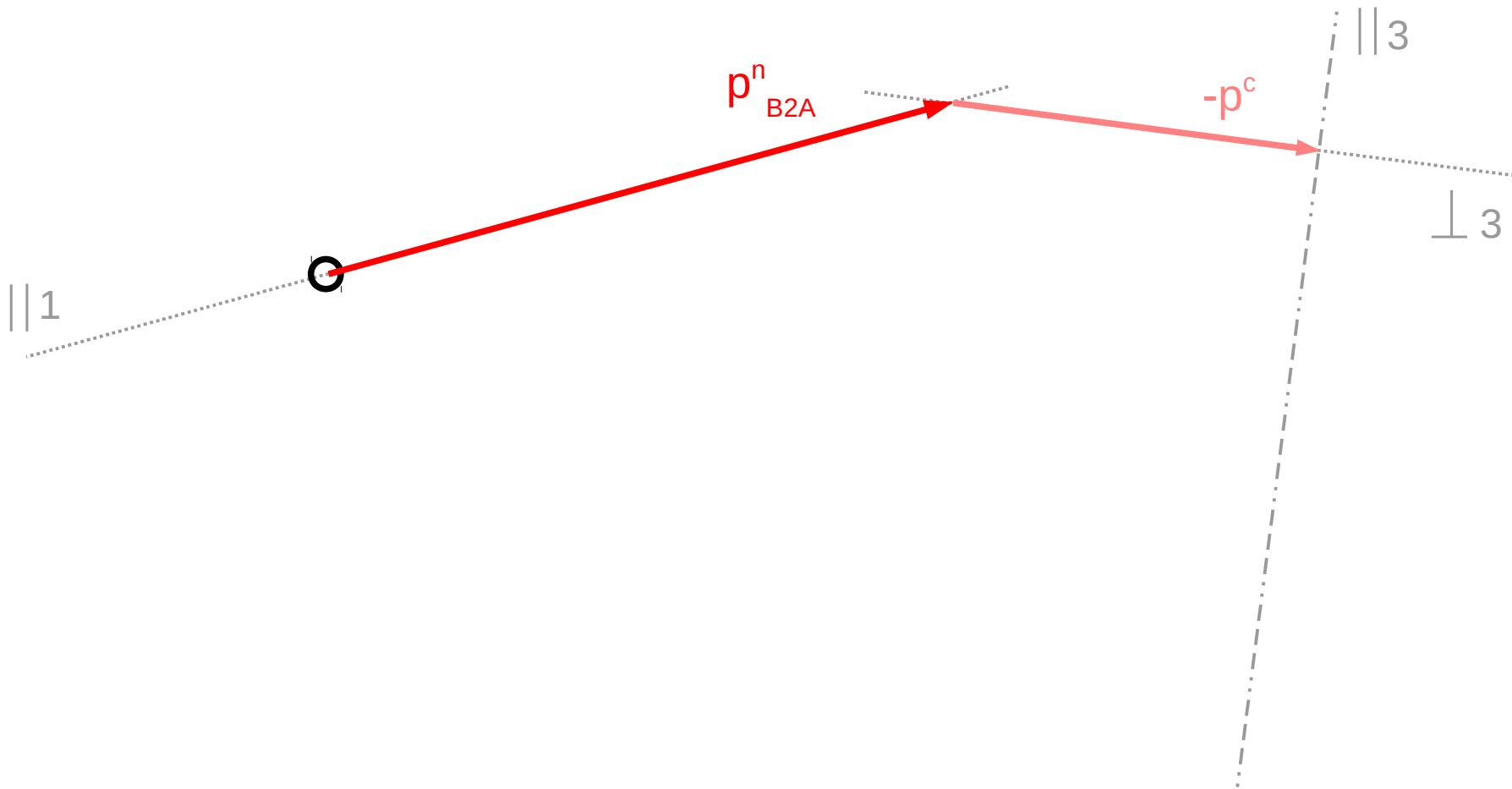

Plan przyspieszeń

$$\frac{\underline{p}_{B2A}^n}{\parallel 1} - \frac{p^c}{\perp 3} - \frac{p^w_{B2B3}}{\parallel 3} = \frac{\underline{p}_{B3G}^n}{\parallel 3} + \frac{p^t_{B3G}}{\perp 3}$$

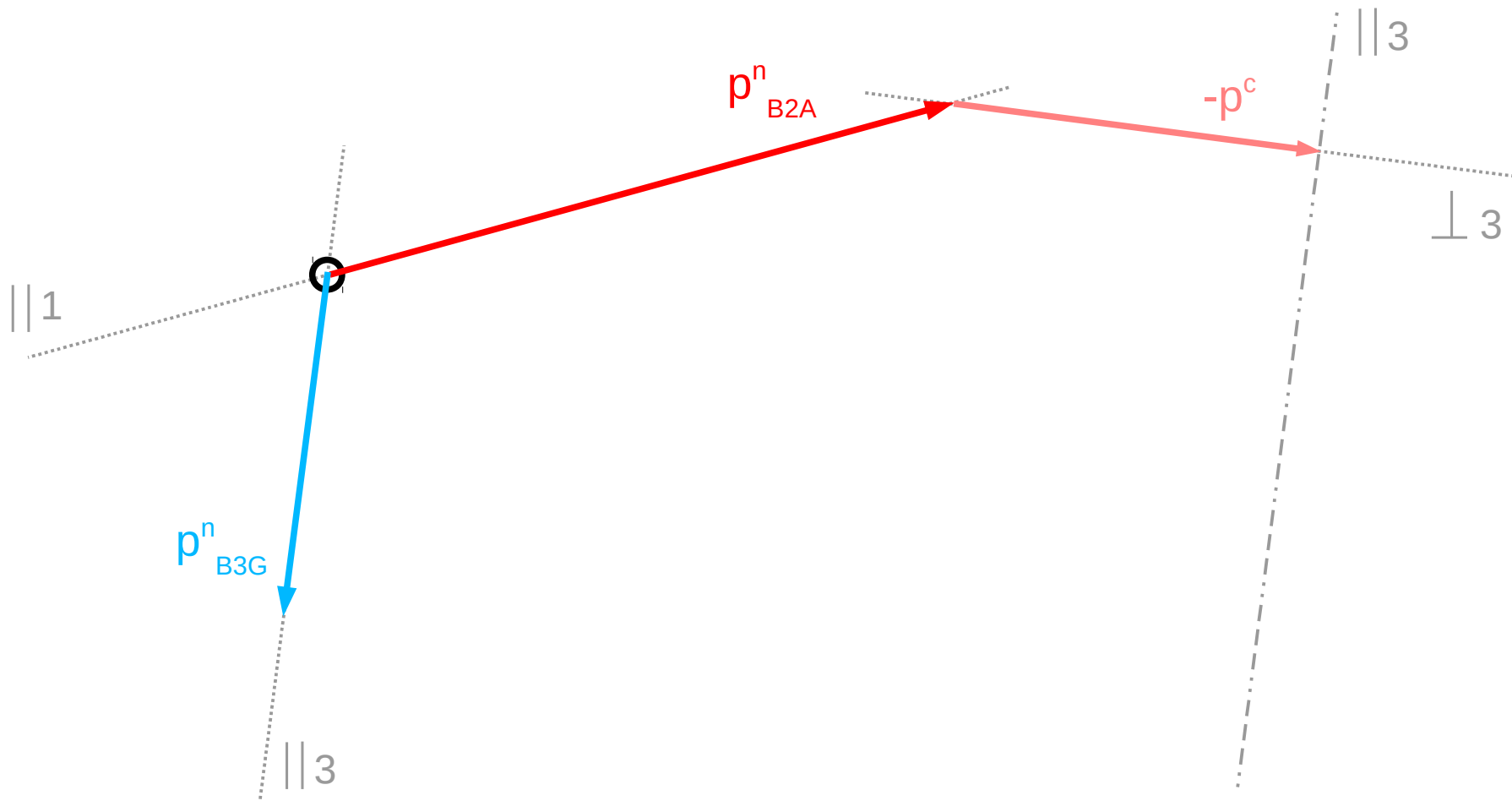

Plan przyspieszeń

$$\frac{\underline{p}_{B2A}^n}{\parallel 1} - \frac{p^c}{\perp 3} - \frac{p^w_{B2B3}}{\parallel 3} = \frac{\underline{p}_{B3G}^n}{\parallel 3} + \frac{p^t_{B3G}}{\perp 3}$$

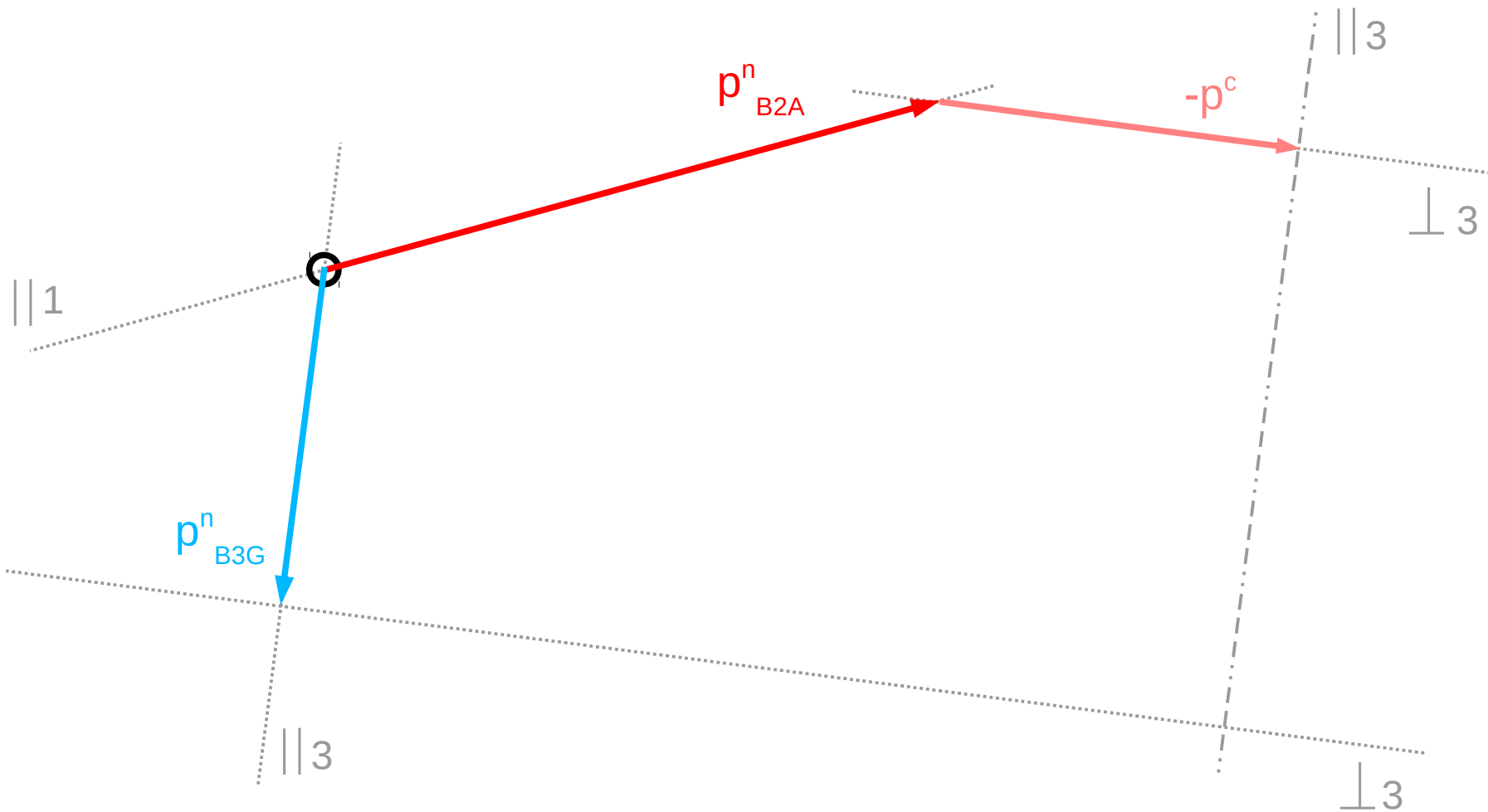

Plan przyspieszeń

$$\frac{\underline{p}_{B2A}^n}{\parallel 1} - \frac{p^c}{\perp 3} = \frac{-p_{B2B3}^w}{\parallel 3} = \frac{p_{B3G}^n}{\parallel 3} + \frac{p_{B3G}^t}{\perp 3}$$

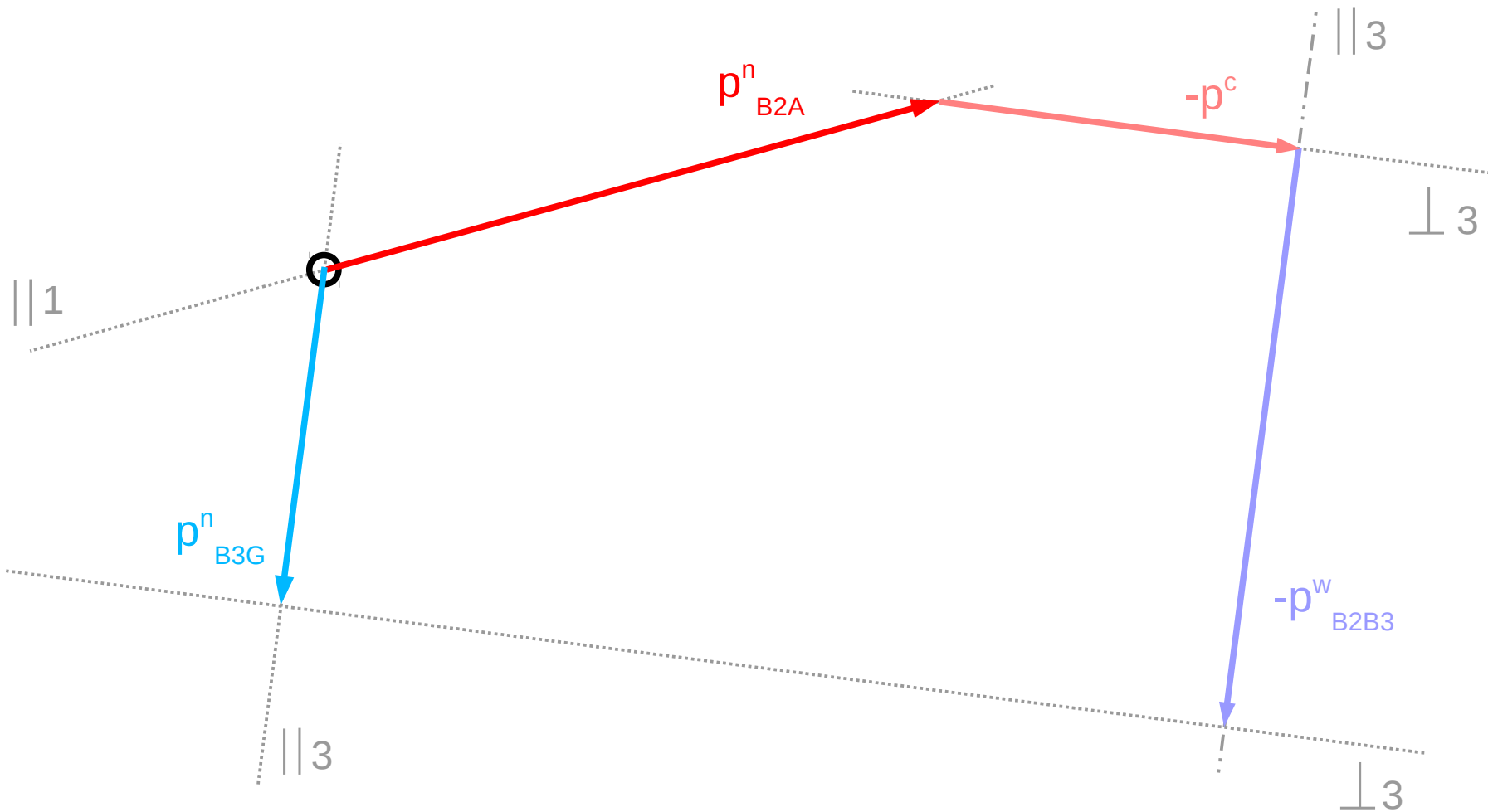

Plan przyspieszeń

$$\frac{\underline{p}_{B2A}^n}{\parallel 1} - \frac{p^c}{\perp 3} = \frac{-p_{B2B3}^w}{\parallel 3} = \frac{p_{B3G}^n}{\parallel 3} + \frac{p_{B3G}^t}{\perp 3}$$

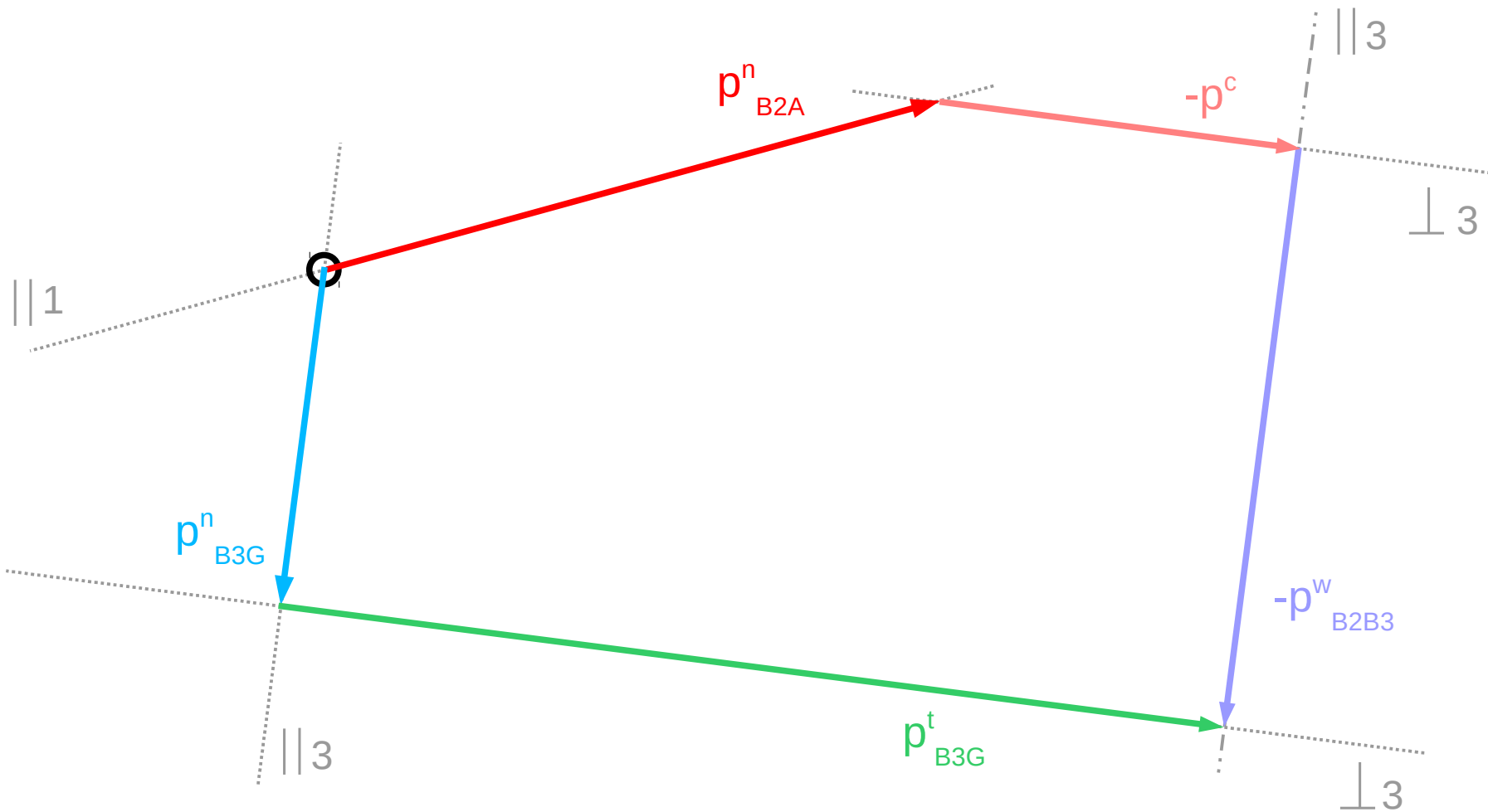

Plan przyspieszeń

$$\begin{array}{c} \underline{\underline{p^n_{B2A}}} \quad \underline{\underline{-p^c}} \quad \underline{\underline{-p^w_{B2B3}}} = \underline{\underline{p^n_{B3G}}} \quad \underline{\underline{+p^t_{B3G}}} \\ \parallel 1 \quad \perp 3 \quad \parallel 3 \quad \parallel 3 \quad \perp 3 \end{array}$$

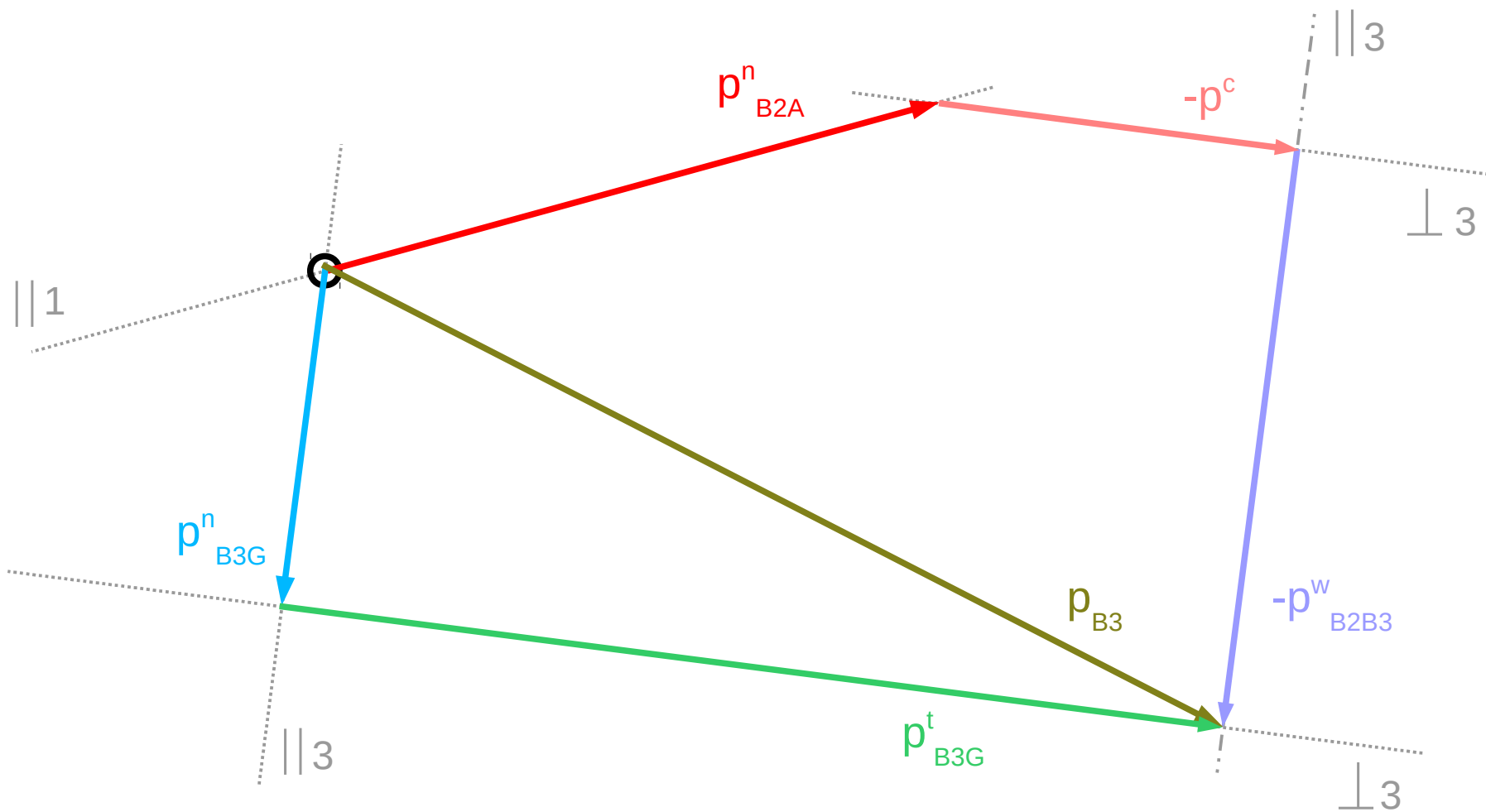

Przyspieszenia dla elementu 3

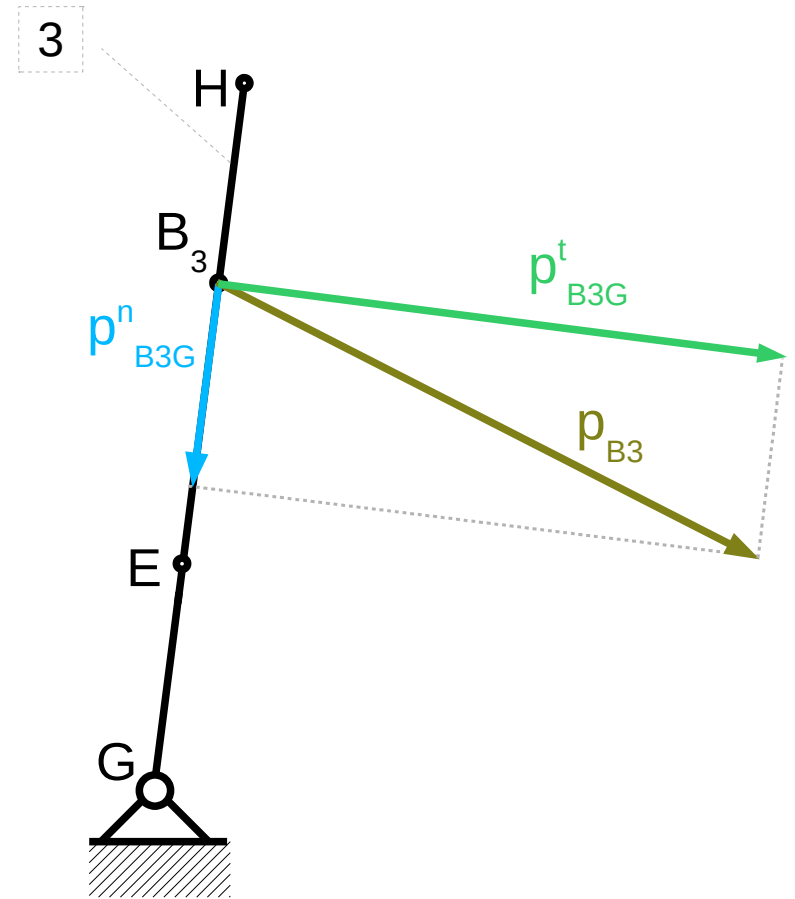
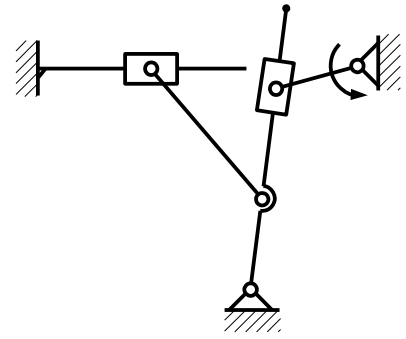

Przyspieszenia dla elementu 3

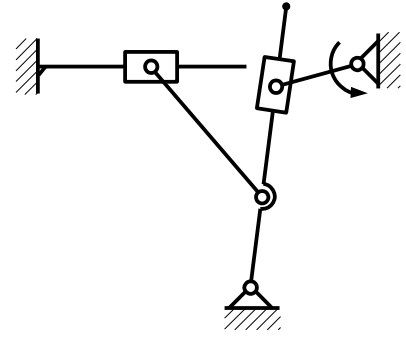

$$\varepsilon_3 = \frac{|p_{B_3G}^t|}{|B_3G|}$$

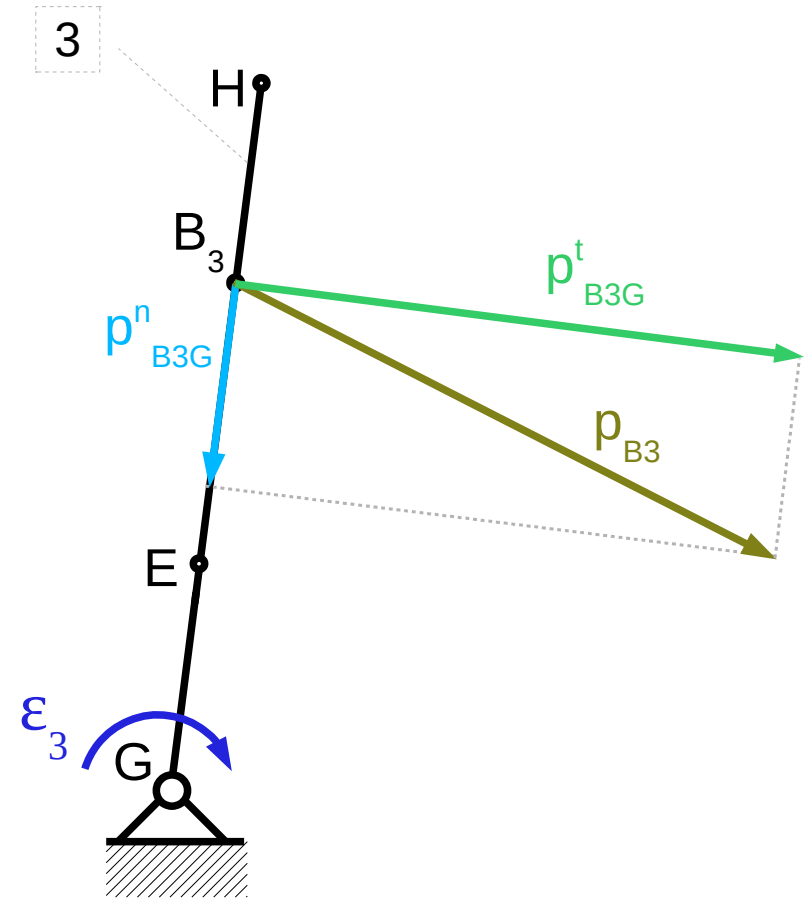

Przyspieszenia dla punktu E

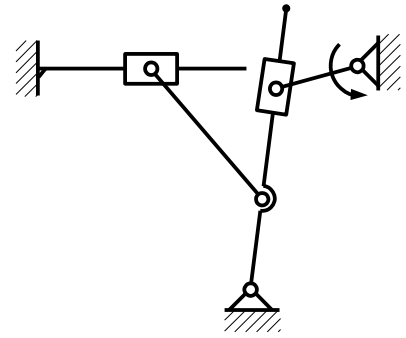

$$\mathbf{p}_E = \mathbf{p}_G + \mathbf{p}_{EG}^n + \mathbf{p}_{EG}^t$$

$$|\mathbf{p}_{EG}^n| = \omega_3^2 |EG|$$

$$|\mathbf{p}_{EG}^t| = \varepsilon_3 |EG|$$

$$\varepsilon_3 = \frac{|\mathbf{p}_{B_3G}^t|}{|B_3G|}$$

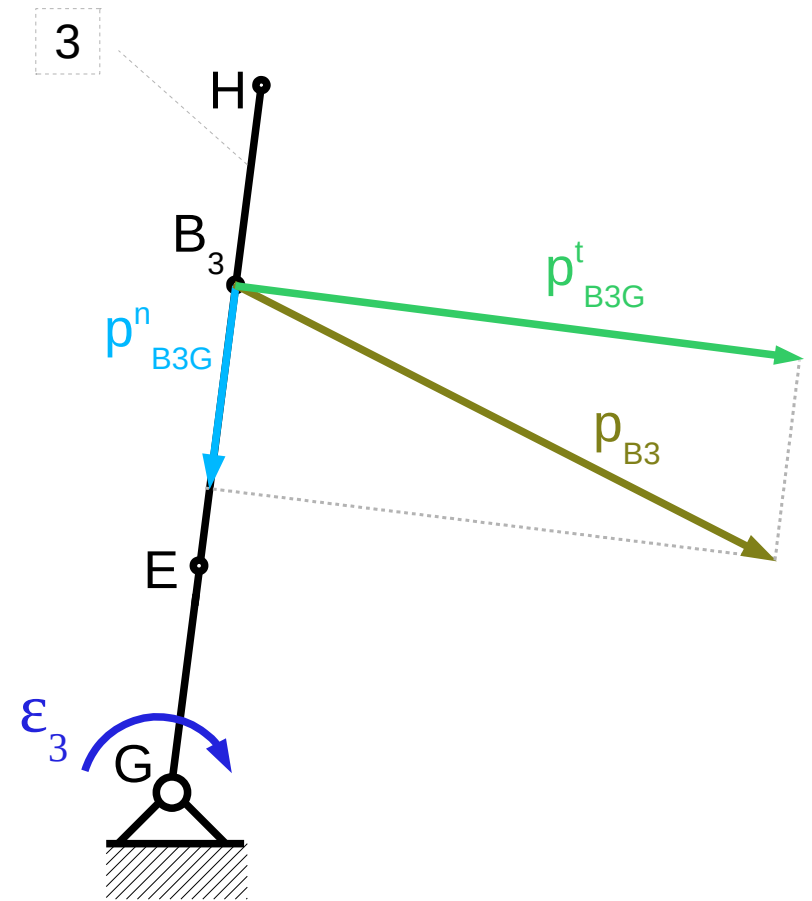

Przyspieszenia dla punktu E

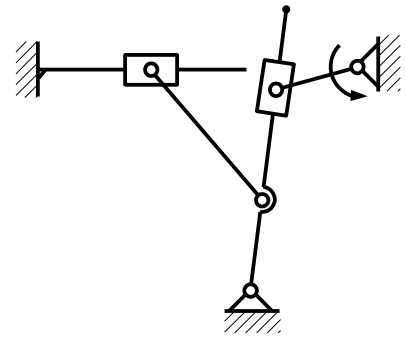

$$\varepsilon_3 = \frac{|p_{B_3G}^t|}{|B_3G|}$$

$$p_E = p_G + p_{EG}^n + p_{EG}^t$$

$$|p_{EG}^n| = \omega_3^2 |EG|$$

$$|p_{EG}^t| = \varepsilon_3 |EG|$$

*podstawiamy
zależności*

$$|p_{B_3G}^n| = \omega_3^2 |B_3G|$$

$$|p_{B_3G}^t| = \varepsilon_3 |B_3G|$$

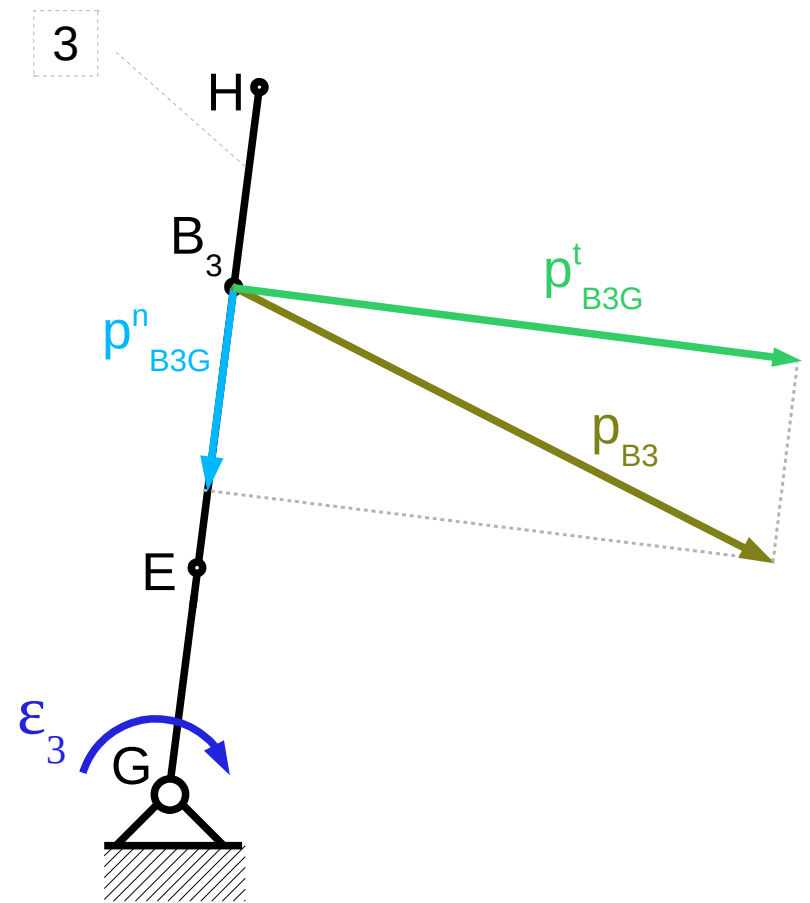

Przyspieszenia dla punktu E

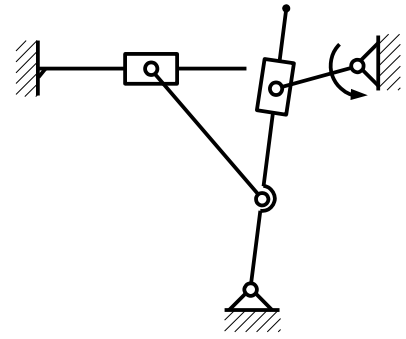

$$\varepsilon_3 = \frac{|p_{B_3G}^t|}{|B_3G|}$$

$$p_E = p_G + p_{EG}^n + p_{EG}^t$$

$$|p_{EG}^n| = \omega_3^2 |EG| = |p_{B_3G}^n| \frac{|EG|}{|B_3G|}$$

$$|p_{EG}^t| = \varepsilon_3 |EG| = |p_{B_3G}^t| \frac{|EG|}{|B_3G|}$$

*podstawiamy
zależności*

$$|p_{B_3G}^n| = \omega_3^2 |B_3G|$$

$$|p_{B_3G}^t| = \varepsilon_3 |B_3G|$$

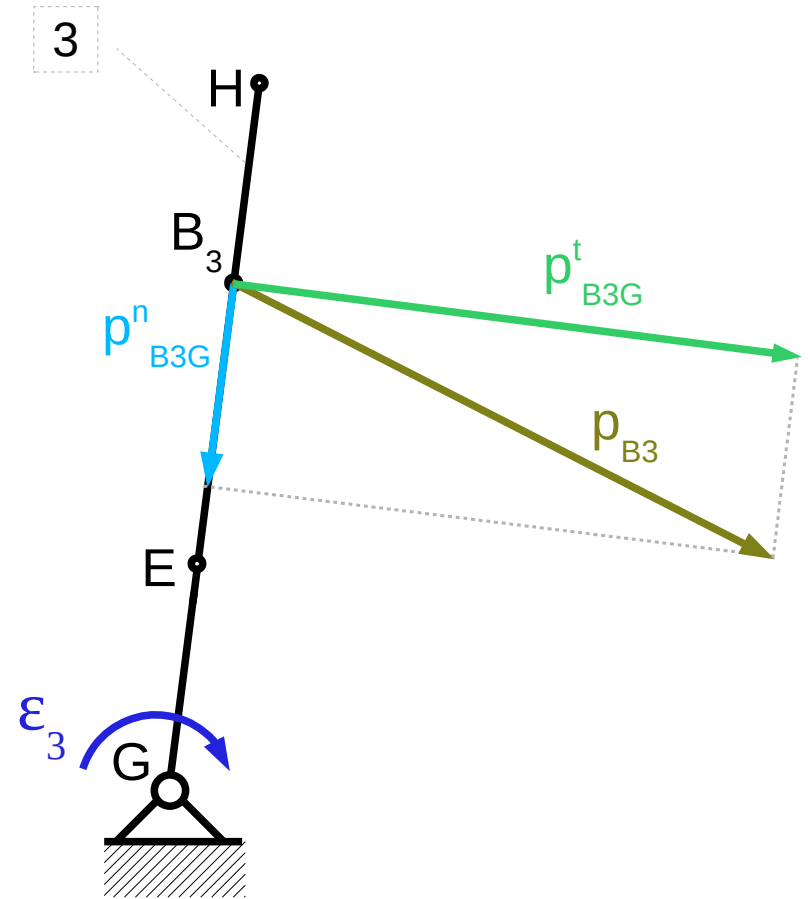

Przyspieszenia dla punktu E

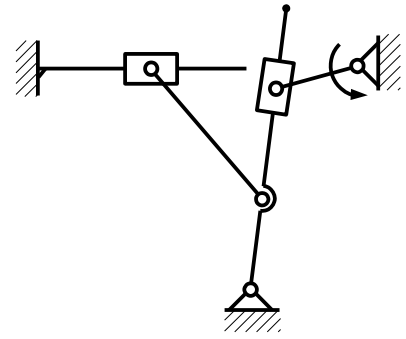

$$\varepsilon_3 = \frac{|p_{B_3G}^t|}{|B_3G|}$$

$$p_E = p_G + p_{EG}^n + p_{EG}^t$$

$$|p_{EG}^n| = \omega_3^2 |EG| = |p_{B_3G}^n| \frac{|EG|}{|B_3G|}$$

$$|p_{EG}^t| = \varepsilon_3 |EG| = |p_{B_3G}^t| \frac{|EG|}{|B_3G|}$$

podstawiamy
zależności

$$|p_{B_3G}^n| = \omega_3^2 |B_3G|$$

$$|p_{B_3G}^t| = \varepsilon_3 |B_3G|$$

i mamy proporcjonalnie
mniejsze przyspieszenia

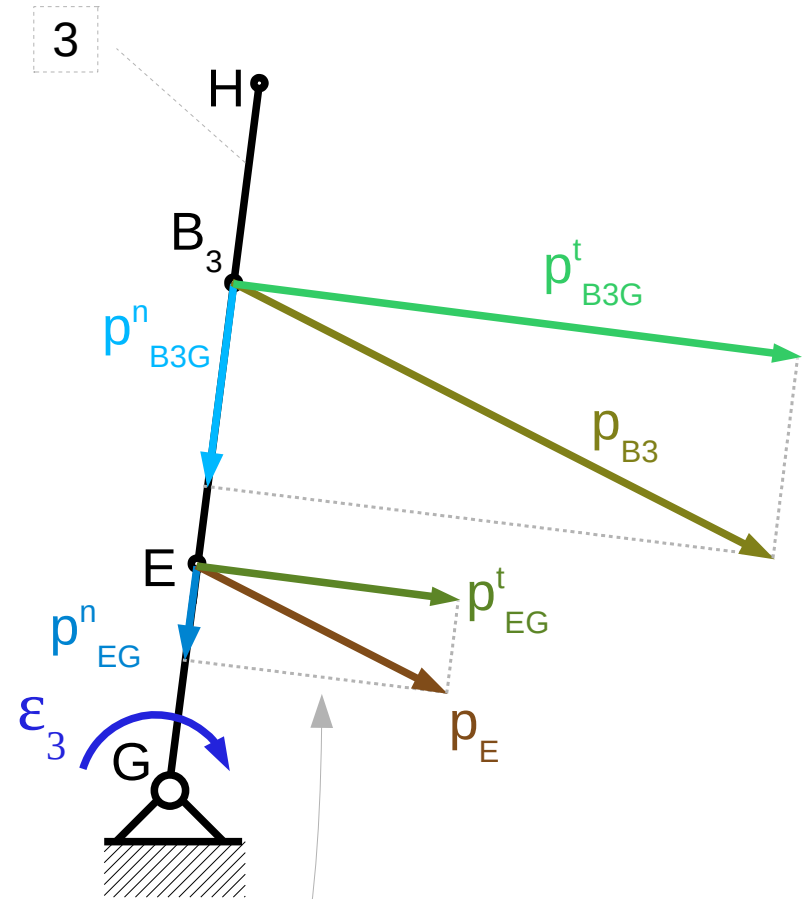

Plan przyspieszeń

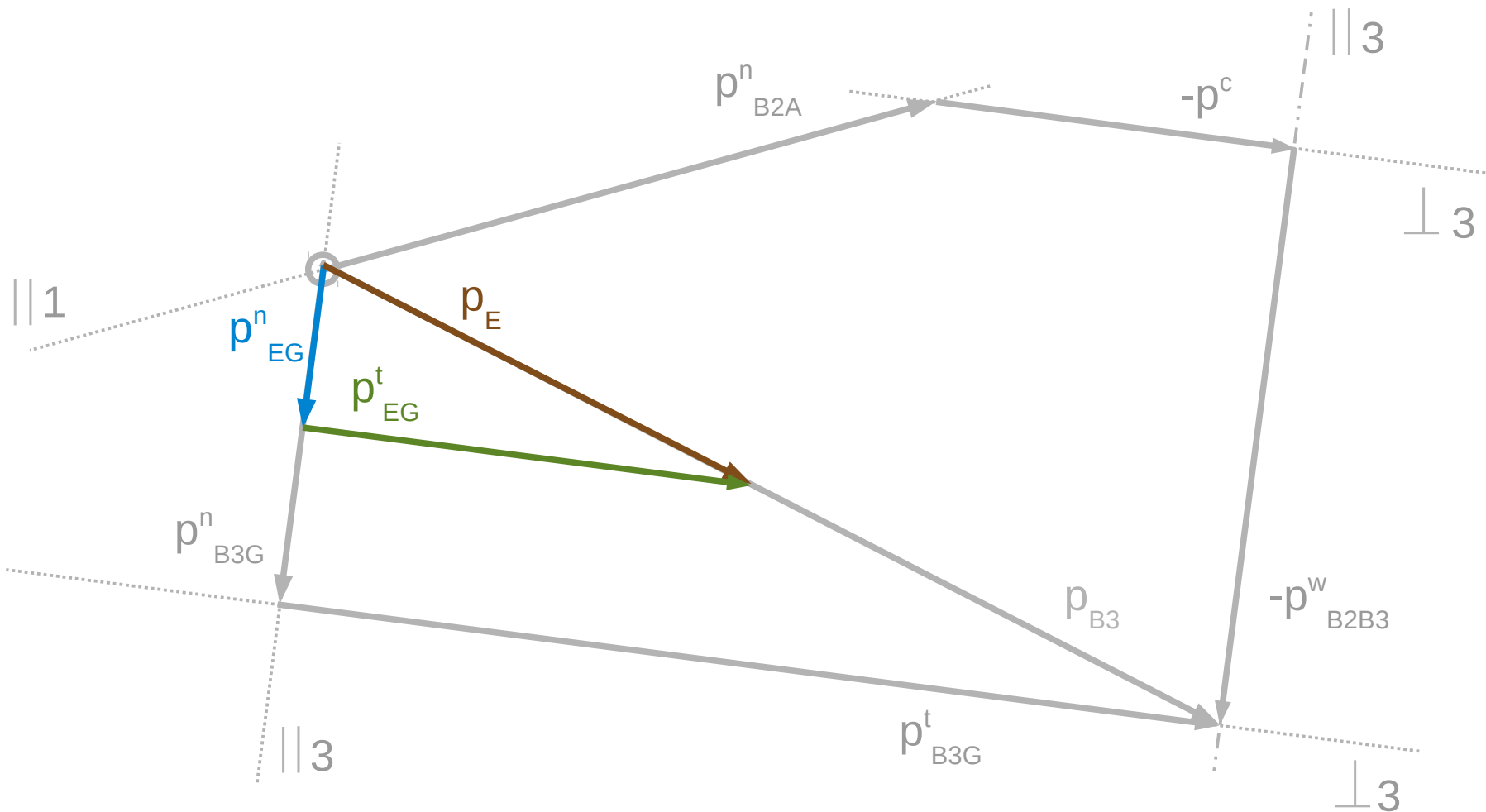

Przyspieszenia punktów elementu 4

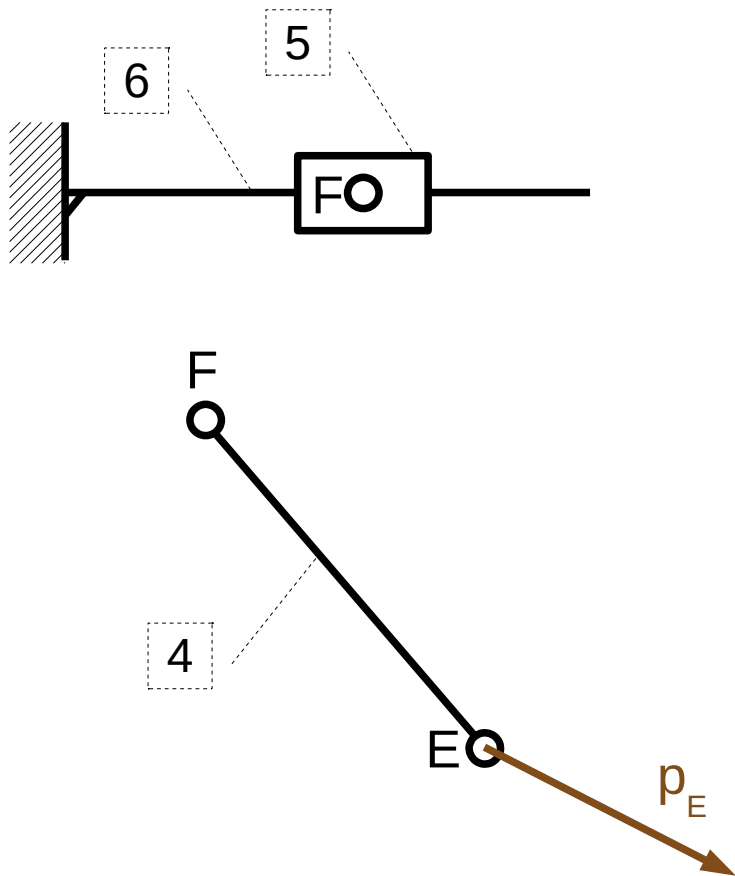

Przyspieszenia punktów elementu 4

$$p_F = p_E + p_{FE}^n + p_{FE}^t$$

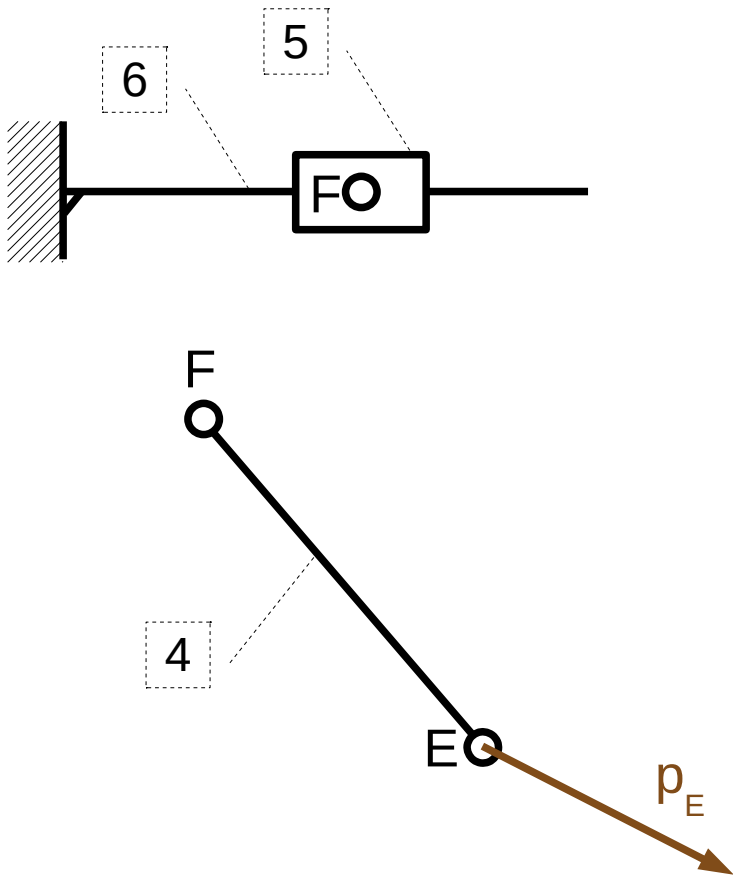

Przyspieszenia punktów elementu 4

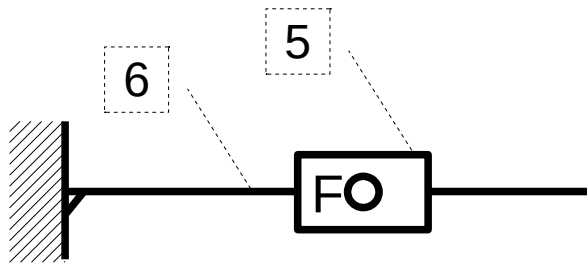

$$\underline{p}_F = \underline{p}_E + \underline{p}_{FE}^n + \underline{p}_{FE}^t$$

$\parallel 4$ $\perp 4$

$$|p_{FE}^n| = \omega_4^2 |FE|$$

z planu prędkości

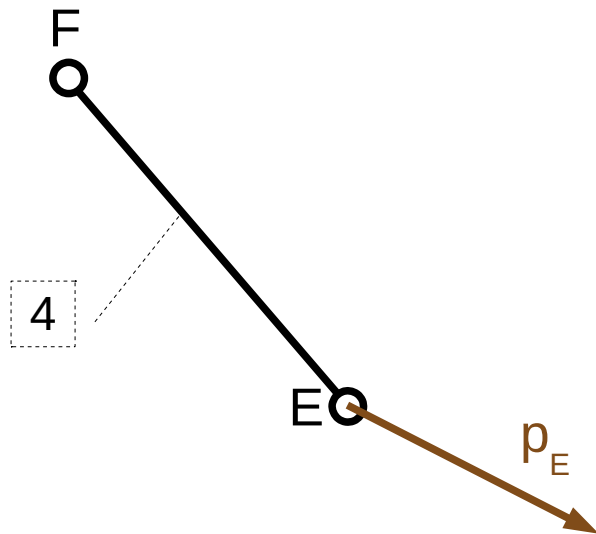

Przyspieszenia punktów elementu 4

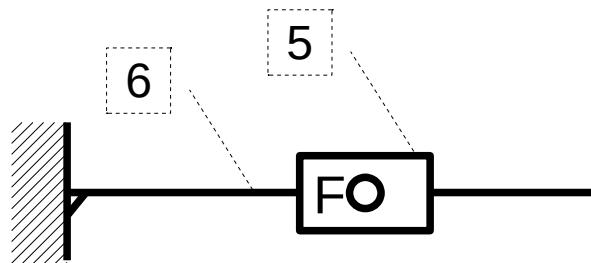

punkt F porusza się po nieruchomym elemencie 6 – przyspieszenie jest styczne do toru ruchu

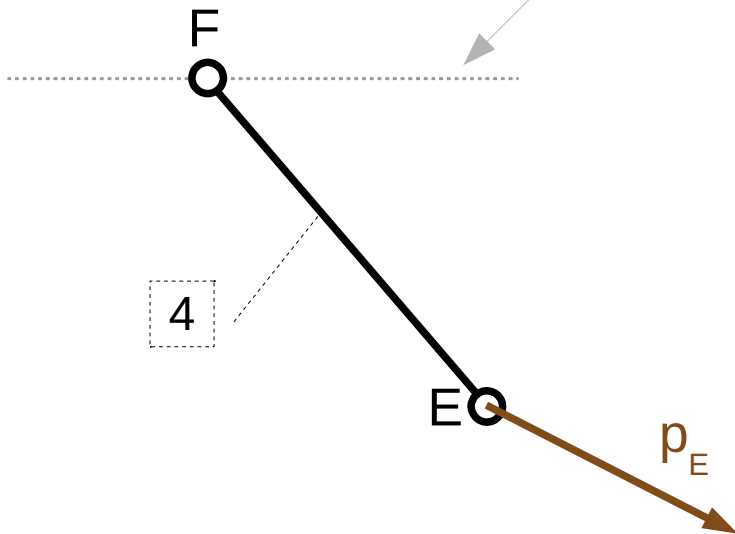

$$\underline{p}_F = \underline{p}_E + \underline{p}_{FE}^n + \underline{p}_{FE}^t$$

$\parallel 6$ $\parallel 4$ $\perp 4$

$$|p_{FE}^n| = \omega_4^2 |FE|$$

z planu prędkości

Plan przyspieszeń

$$\frac{p_F}{\parallel 6} = \underbrace{\frac{p_E}{\parallel 4}}_{\text{brown circle}} + \frac{p_{FE}^n}{\parallel 4} + \frac{p_{FE}^t}{\perp 4}$$

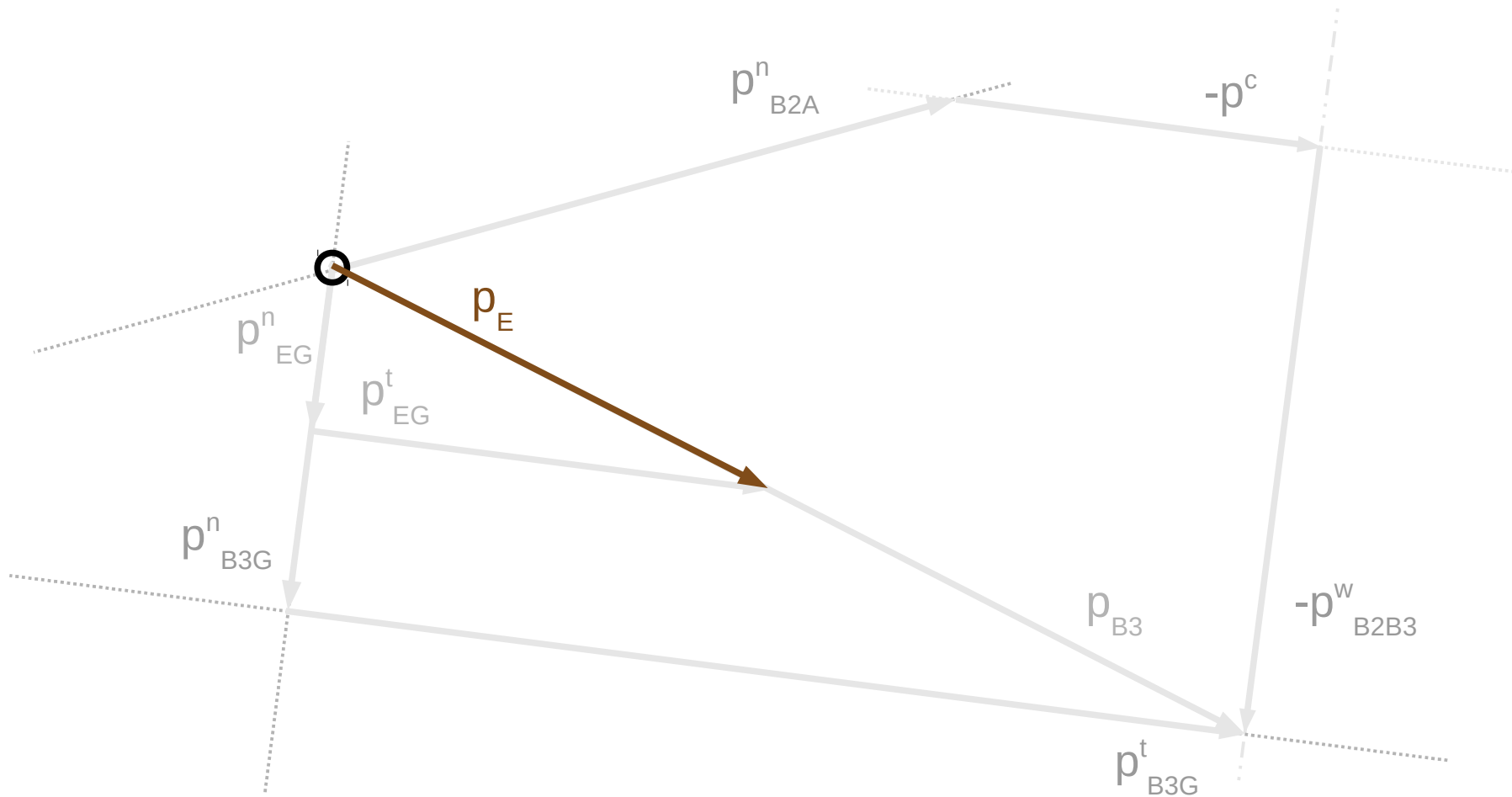

Plan przyspieszeń

$$\frac{p_F}{\parallel 6} = \frac{p_E}{\parallel 6} + \frac{p_{FE}^n}{\parallel 4} + \frac{p_{FE}^t}{\perp 4}$$

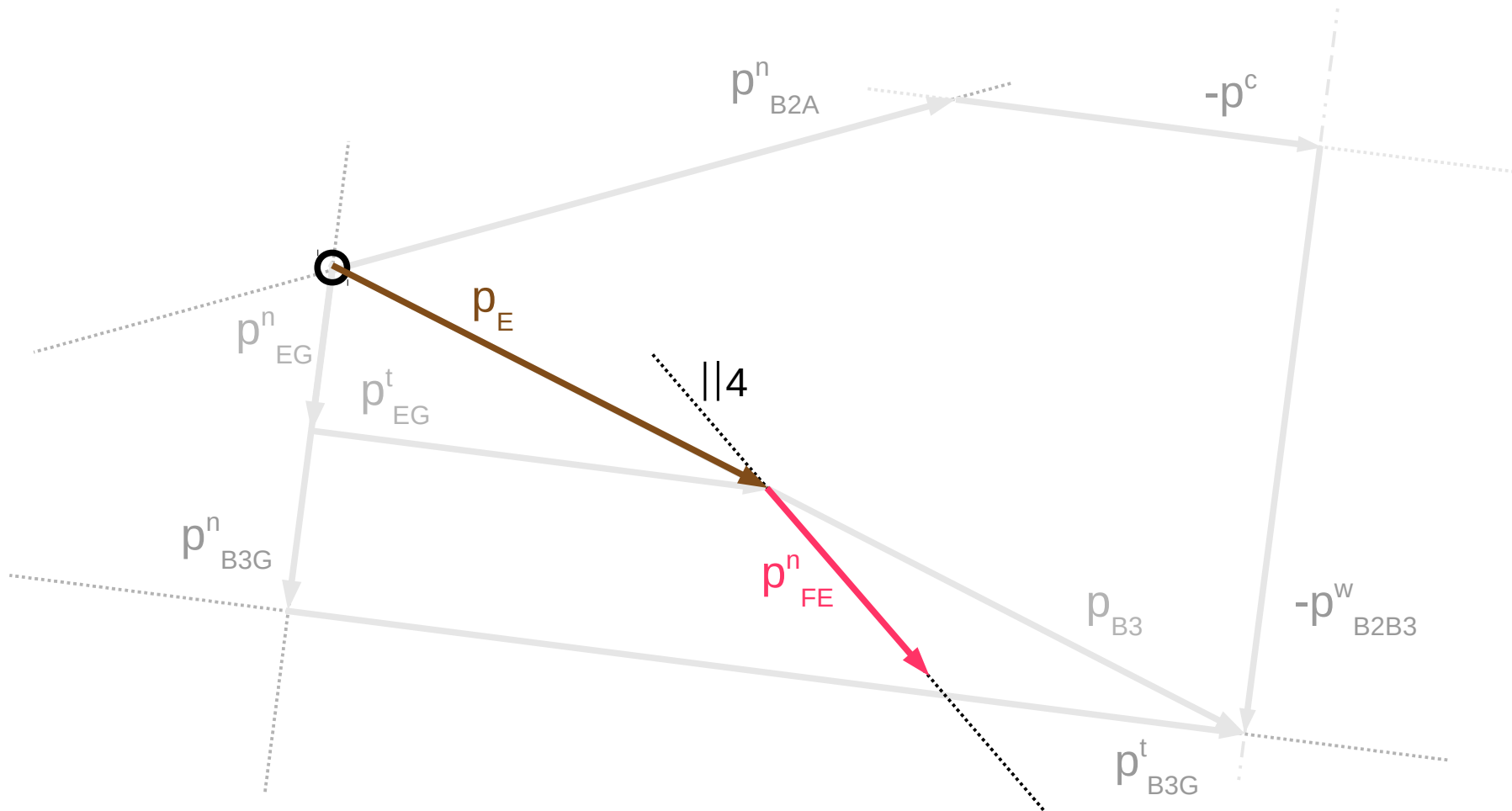

Plan przyspieszeń

$$\frac{p_F}{\parallel 6} = \frac{p_E}{\parallel 6} + \frac{p_{FE}^n}{\parallel 4} + \frac{p_{FE}^t}{\perp 4}$$

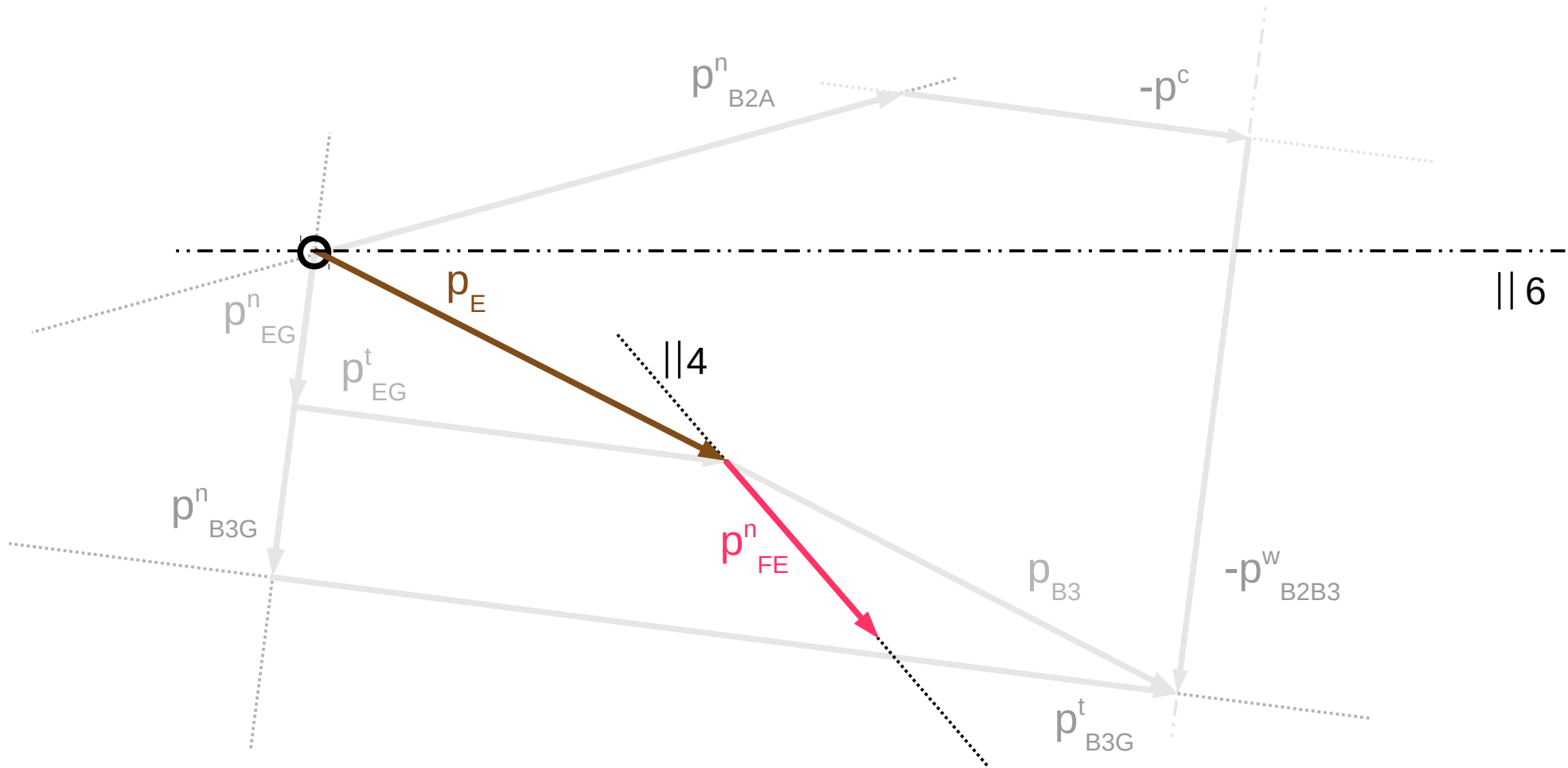

Plan przyspieszeń

$$\frac{p_F}{\parallel 6} = \frac{p_E}{\parallel 6} + \frac{p_{FE}^n}{\parallel 4} + \frac{p_{FE}^t}{\perp 4}$$

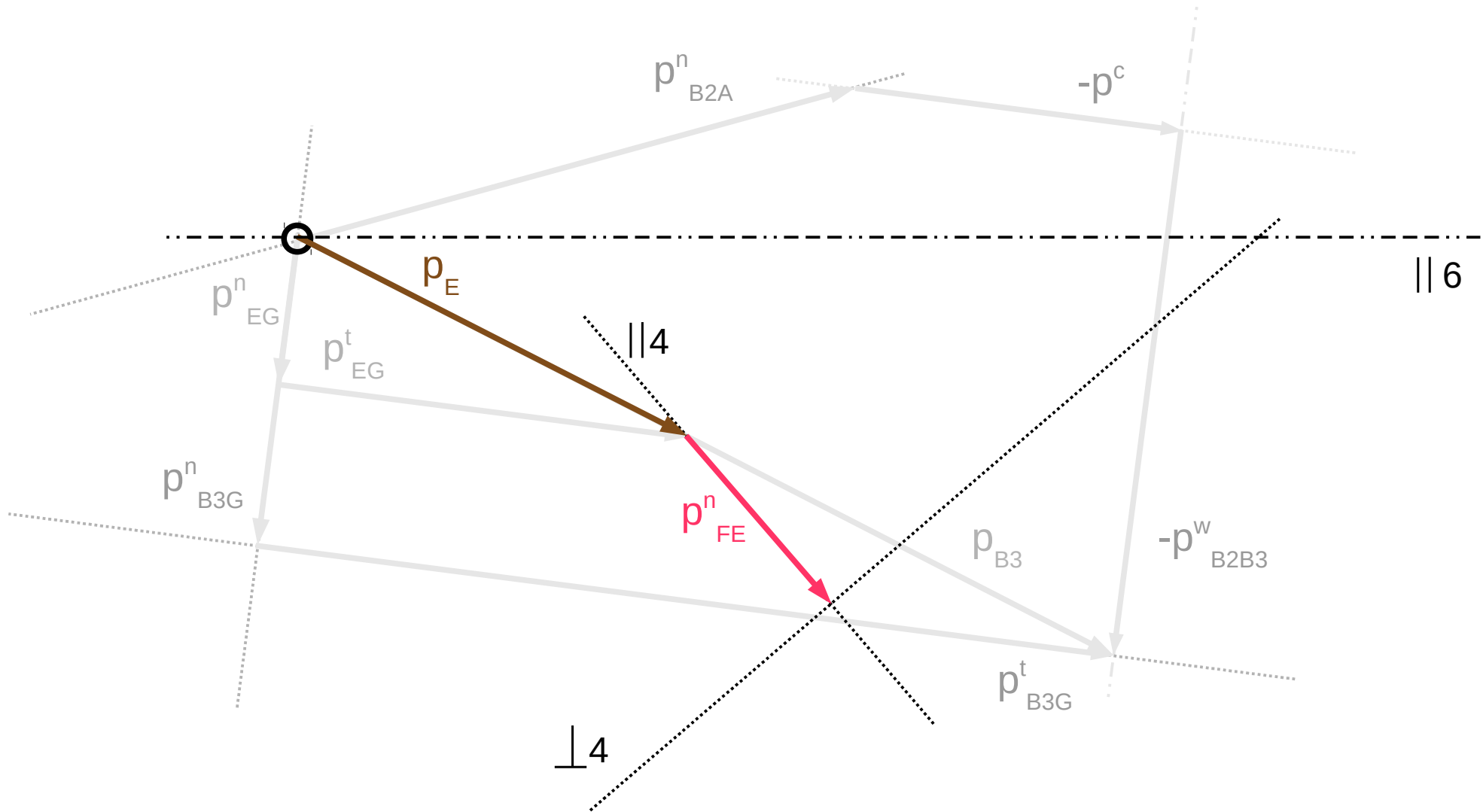

Plan przyspieszeń

$$\frac{p_F}{\parallel 6} = \frac{p_E}{\parallel 6} + \frac{p_{FE}^n}{\parallel 4} + \frac{p_{FE}^t}{\perp 4}$$

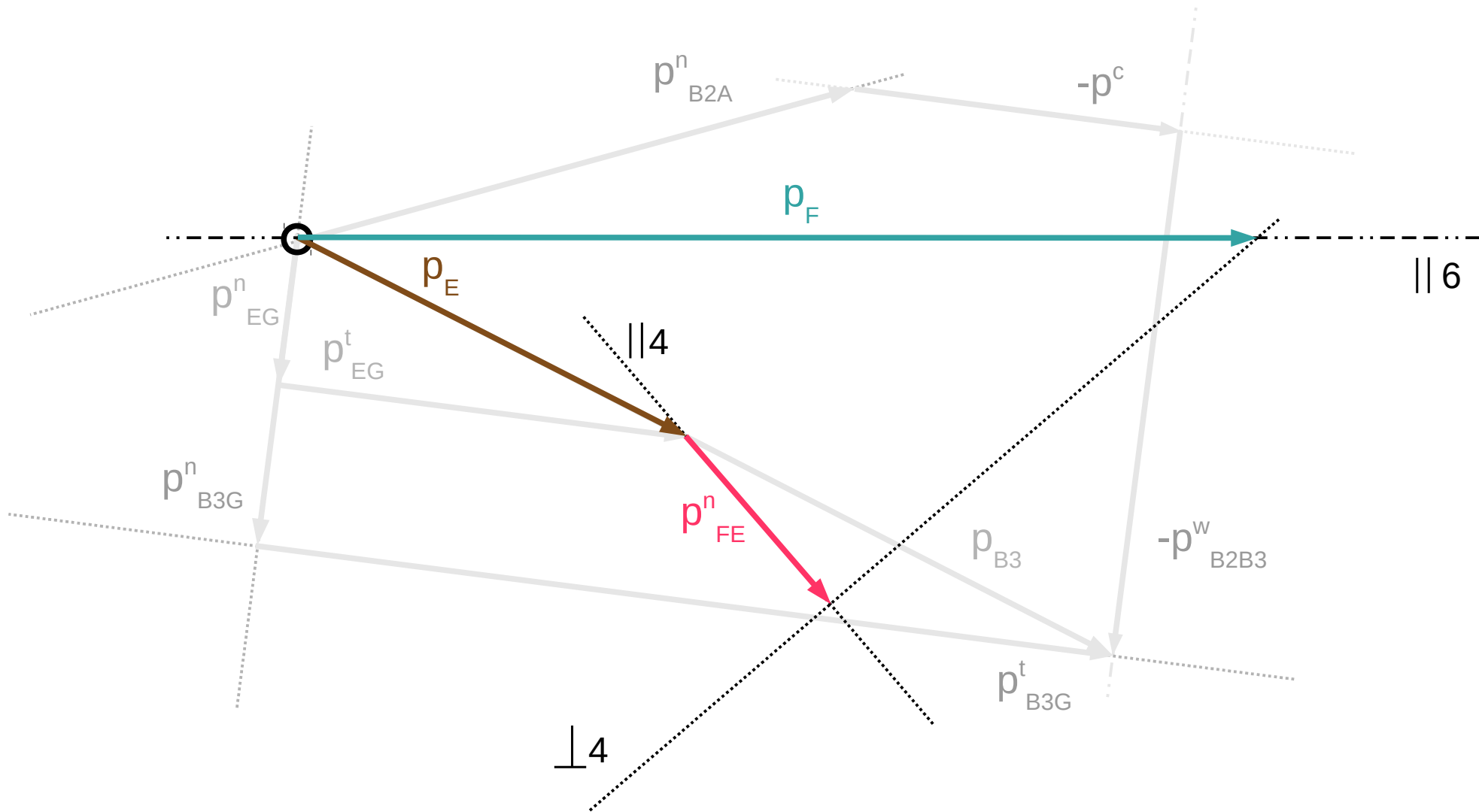

Plan przyspieszeń

$$\frac{p_F}{\parallel 6} = \frac{p_E}{\parallel 6} + \frac{p_{FE}^n}{\parallel 4} + \frac{p_{FE}^t}{\perp 4}$$

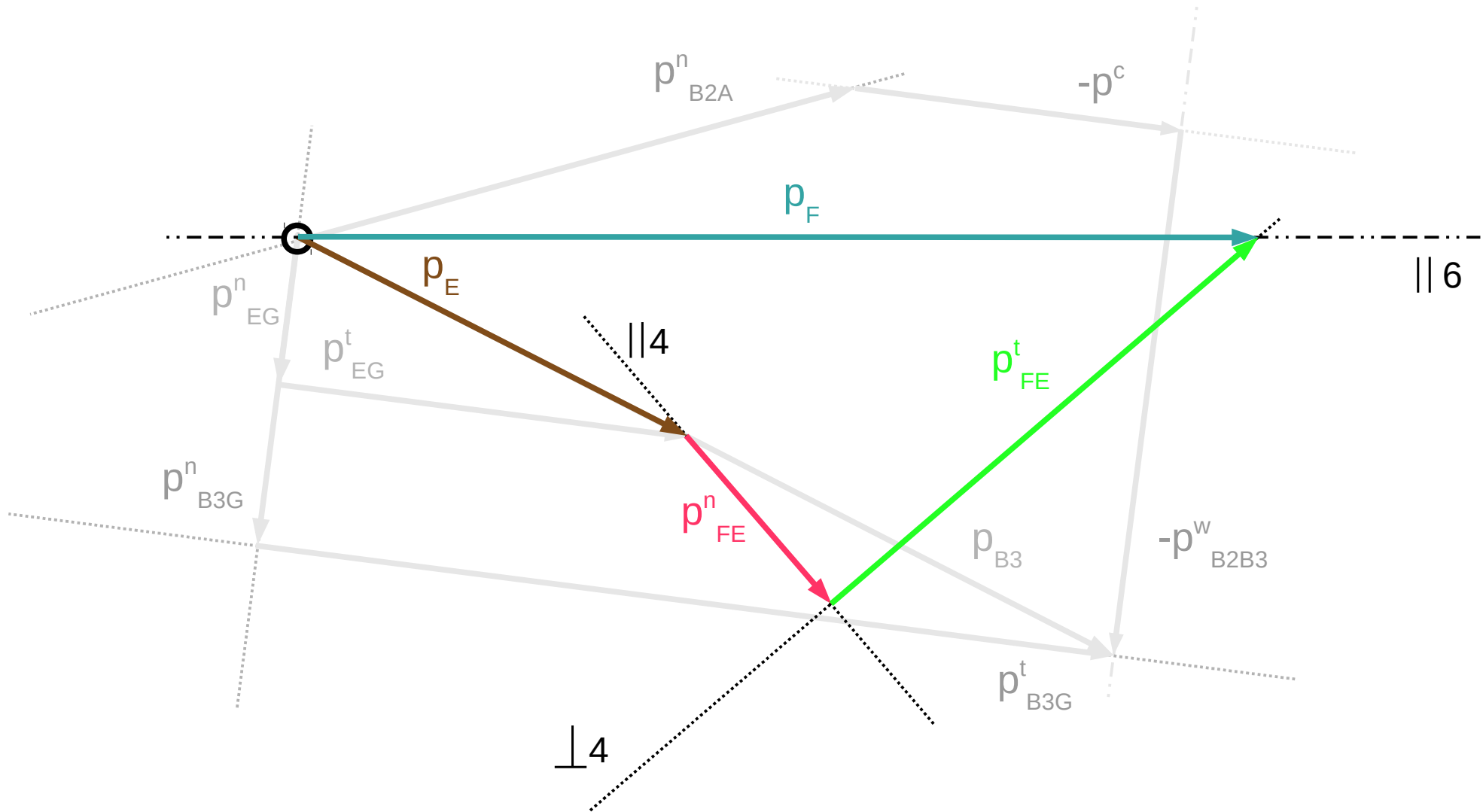

Przyspieszenia punktów elementu 4

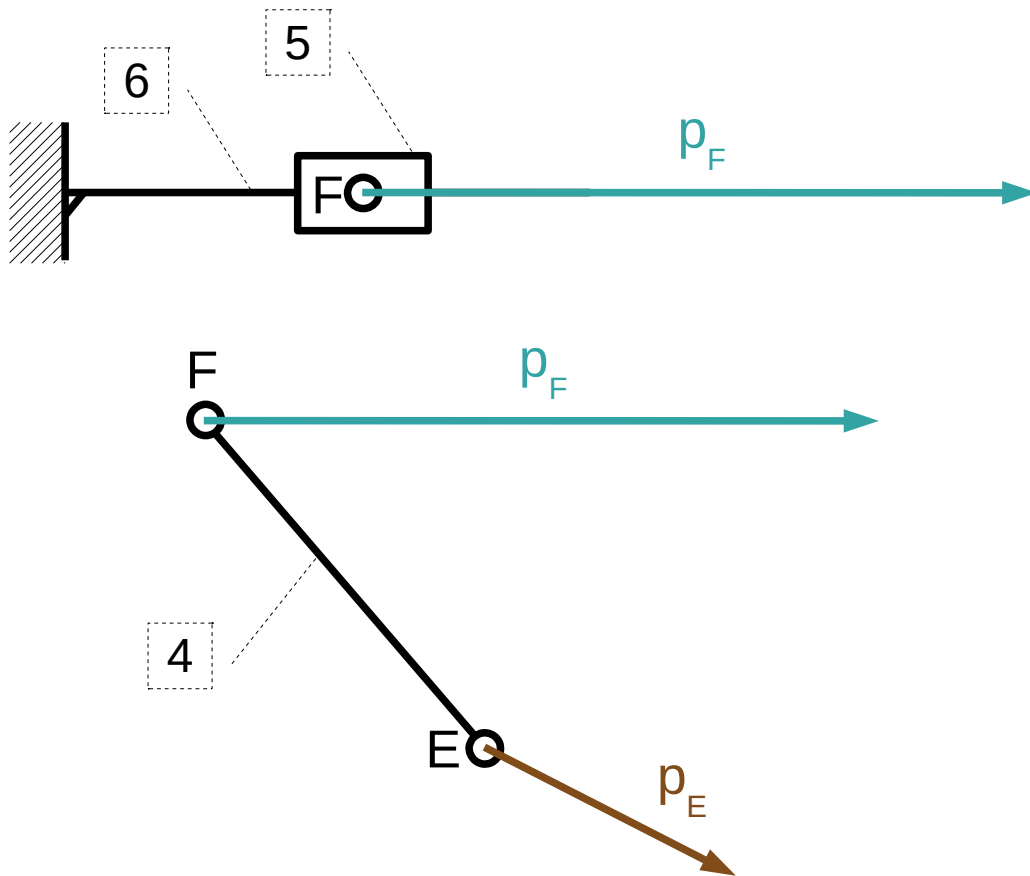

Przyspieszenia punktów elementu 4

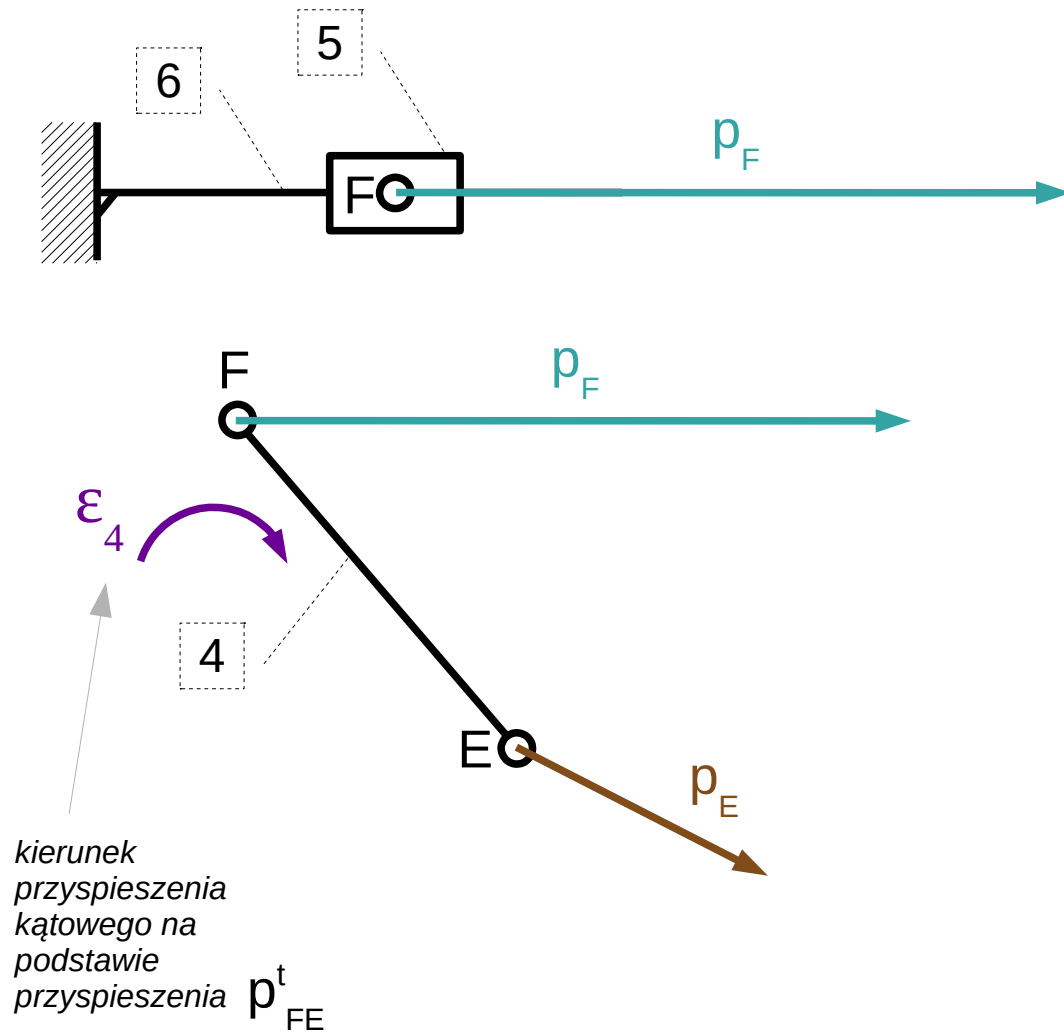

Przyspieszenia w całym mechanizmie

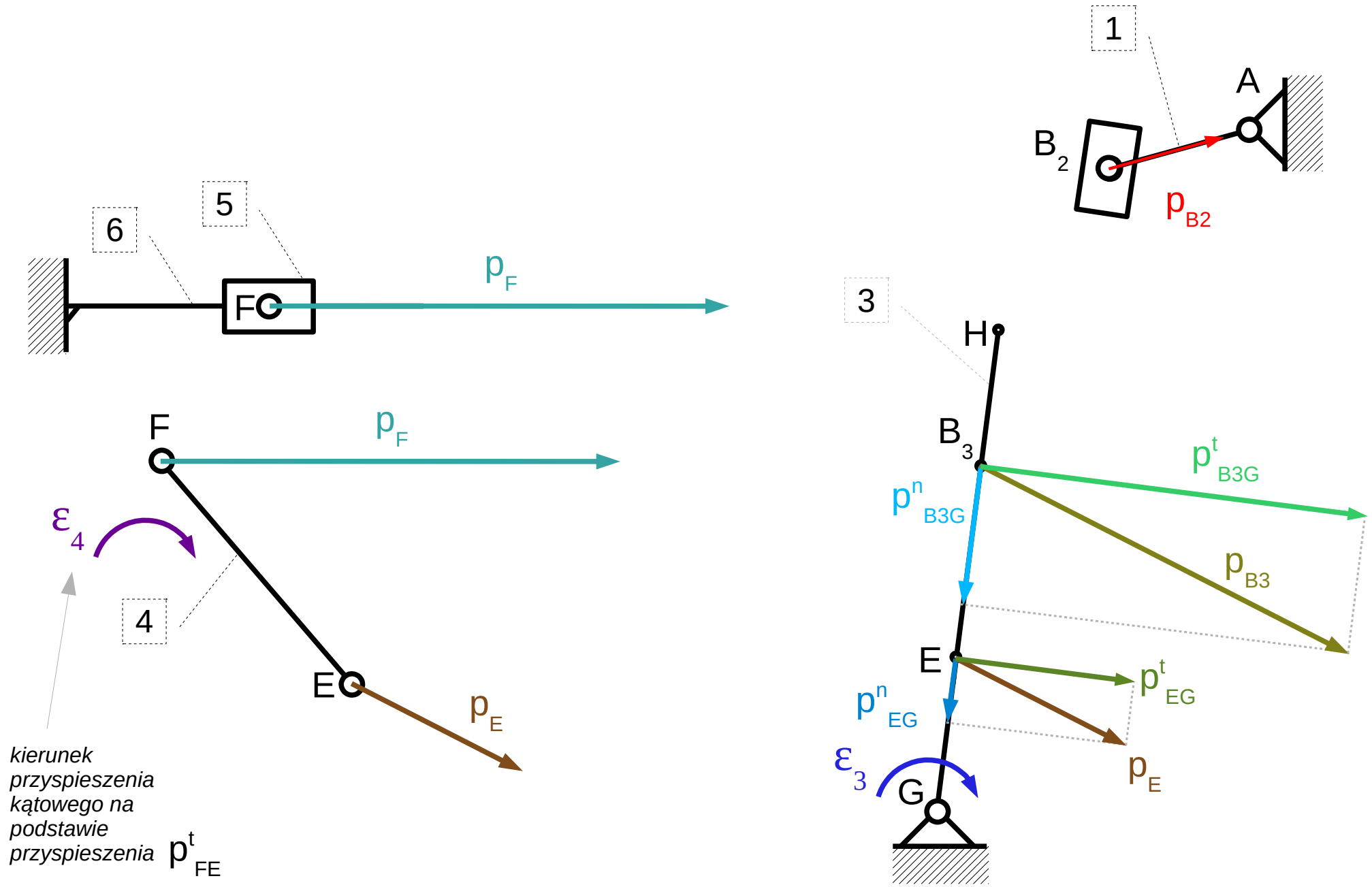

Wybrane przyspieszenia w mechanizmie

