



Faculty of Automotive and Construction Machinery Engineering

WARSAW UNIVERSITY OF TECHNOLOGY

Theory of Machines and Automatic Control Winter 2018/2019

Lecturer: Sebastian Korczak, PhD, Eng.

Lecture 5

Cam-follower mechanisms cont. Dynamics of planar mechanisms.

Materials license: only for educational purposes of Warsaw University of Technology students.

Cam-follower mechanisms cont.

Analysis and synthesis of cam-follower mechanisms

<u>Analysis</u>	<u>Syntesis</u>
<ul style="list-style-type: none">• substitution of IV. class kinematic pair with V. class kinematic pairs + graphical method (velocity and acceleration scheme)• graphical determination of a follower movement and graphical differentiation• analytical method (substitution with polygones of vectors)	<ul style="list-style-type: none">• graphical determination of cam outline by a base circle rotation with follower movement• analytical designing with a function description

Analysis of a cam-follower mechanism

Analytical method - example

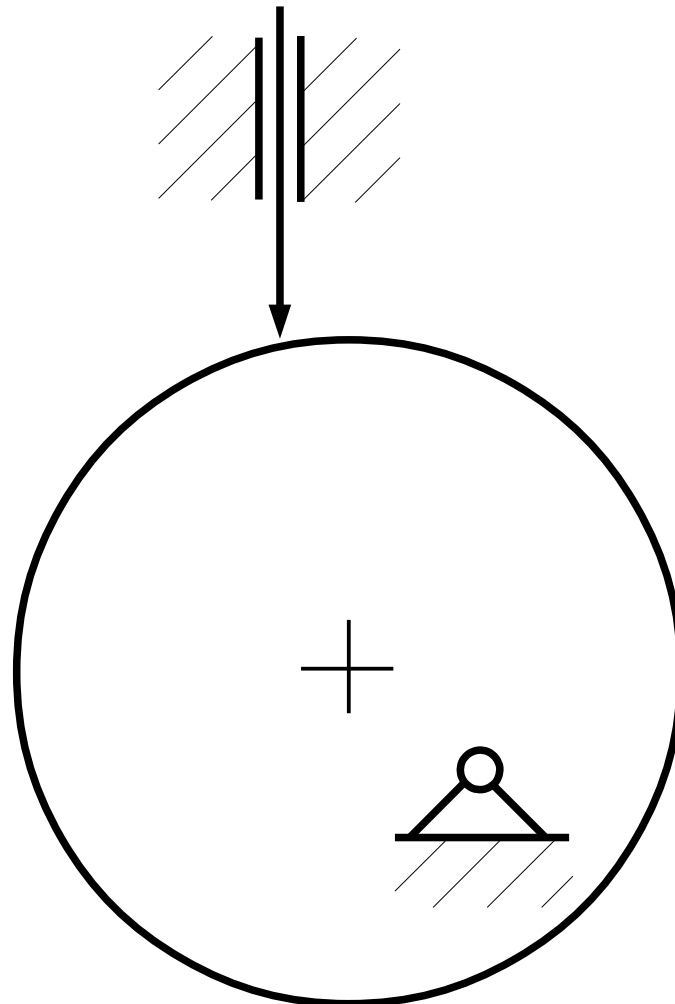

Synthesis of cam-follower mechanisms

Graphical method

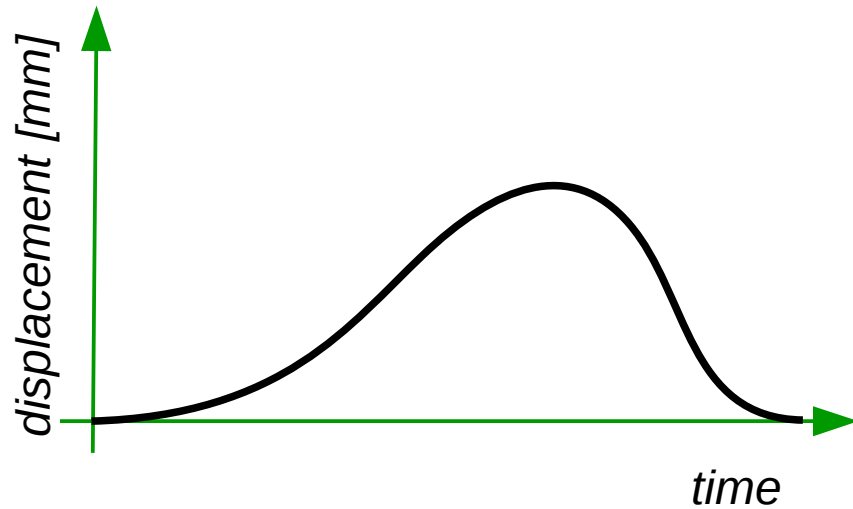

Synthesis of cam-follower mechanisms

Graphical method



Assumption: constant
angular velocity of a cam

$$\varphi(t) = \omega t$$

Synthesis of cam-follower mechanisms

Graphical method

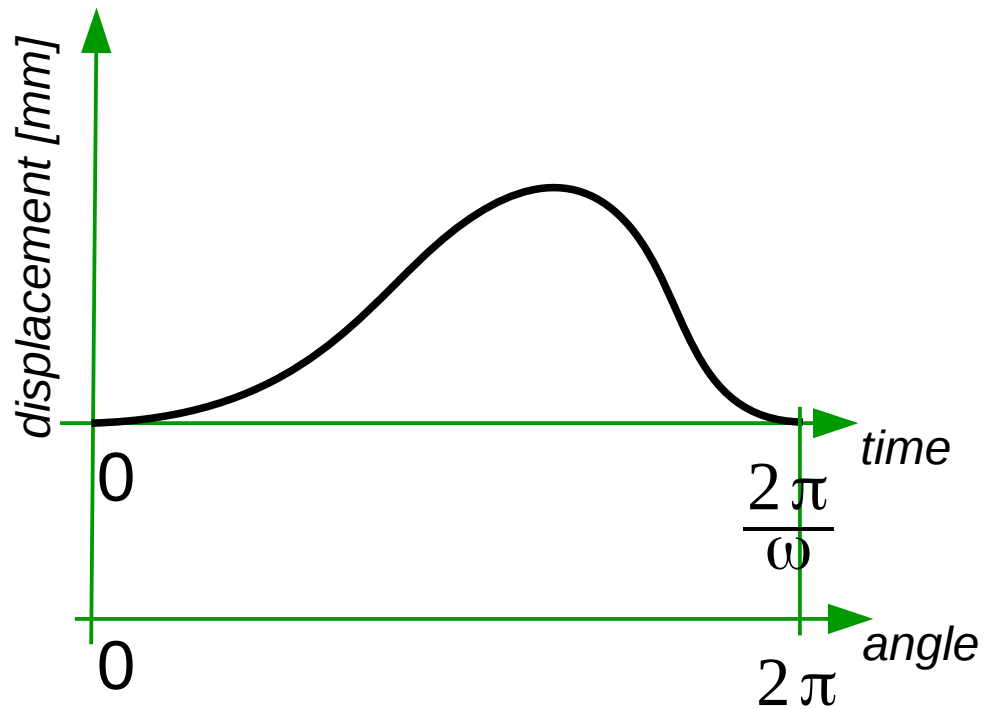

Synthesis of cam-follower mechanisms

Graphical method

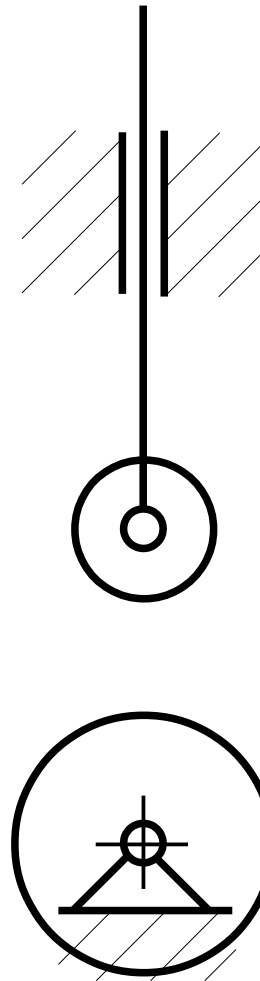
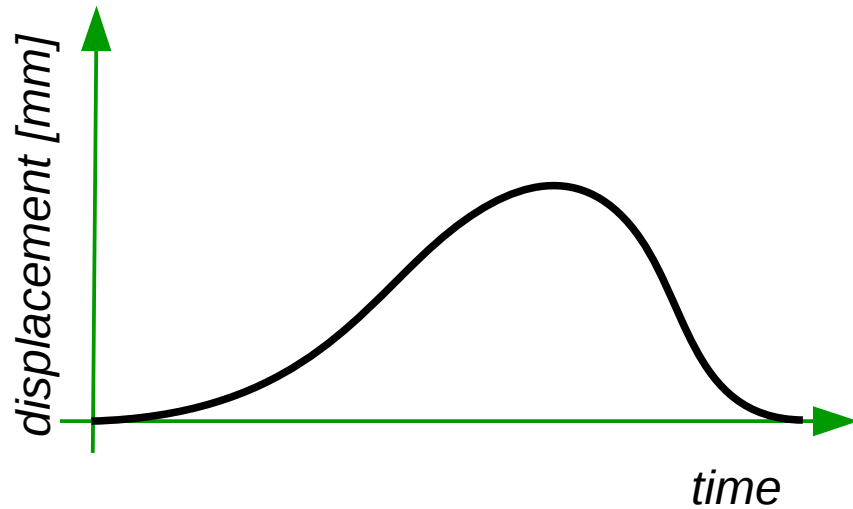

Synthesis of cam-follower mechanisms

Graphical method

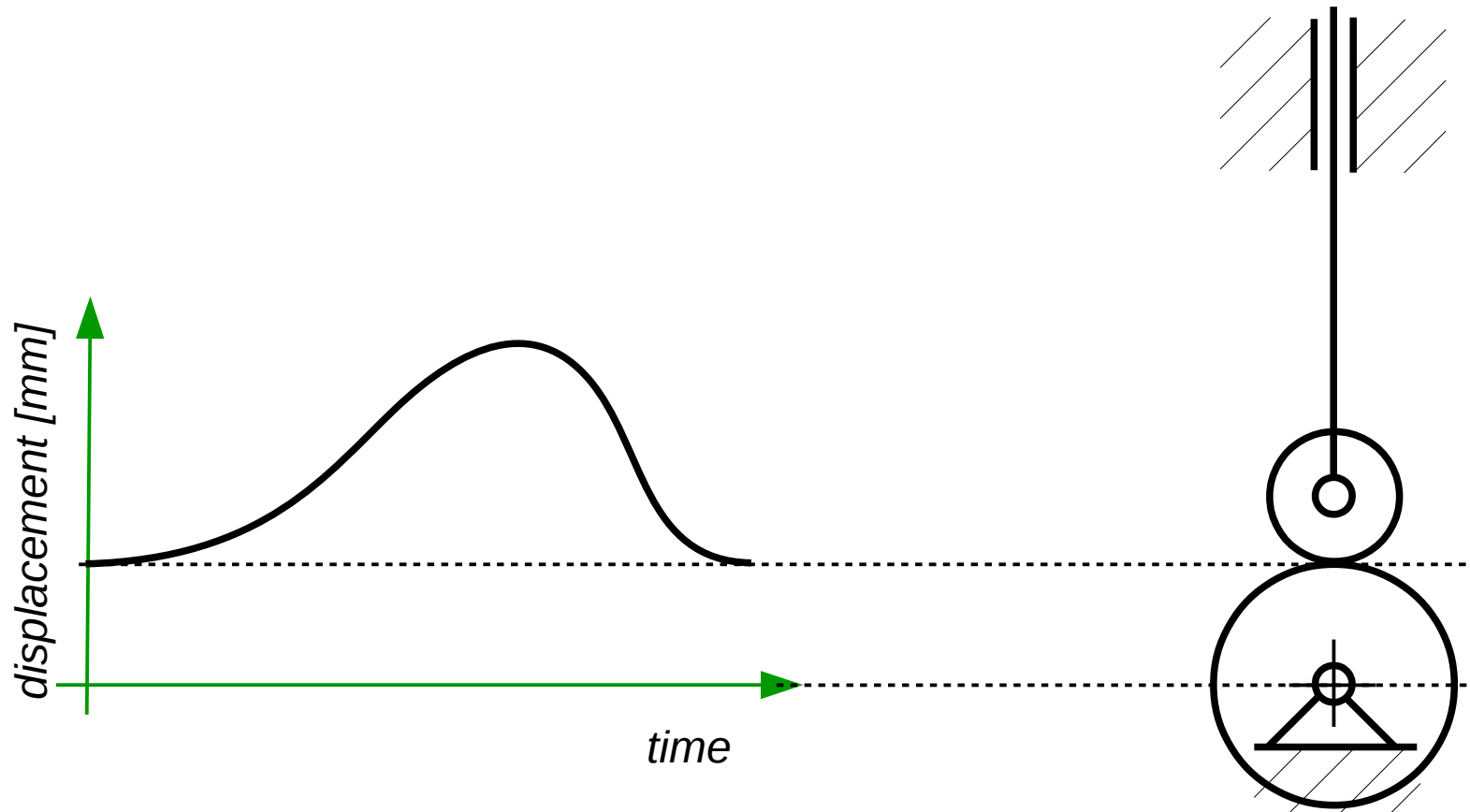

Synthesis of cam-follower mechanisms

Graphical method

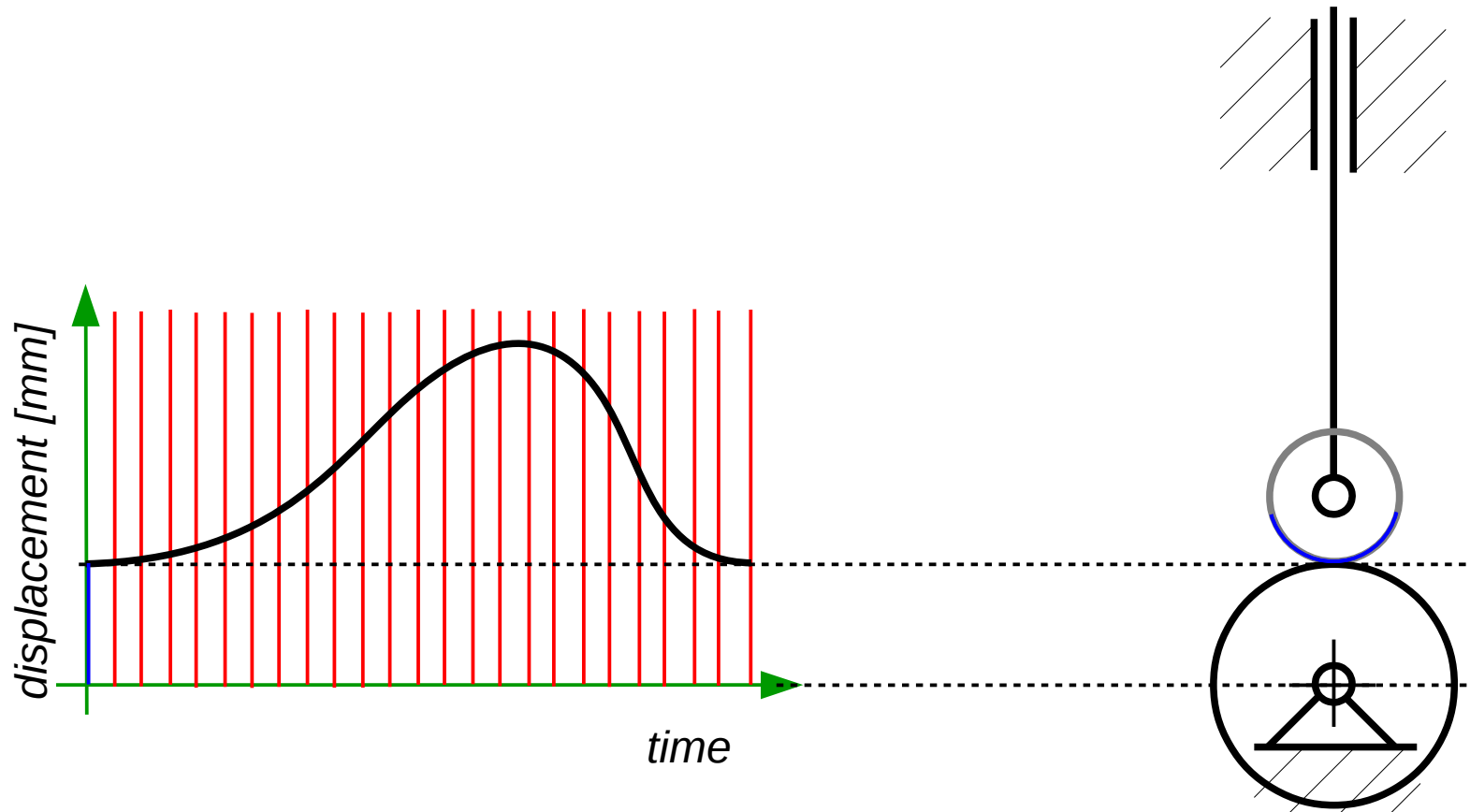

Synthesis of cam-follower mechanisms

Graphical method

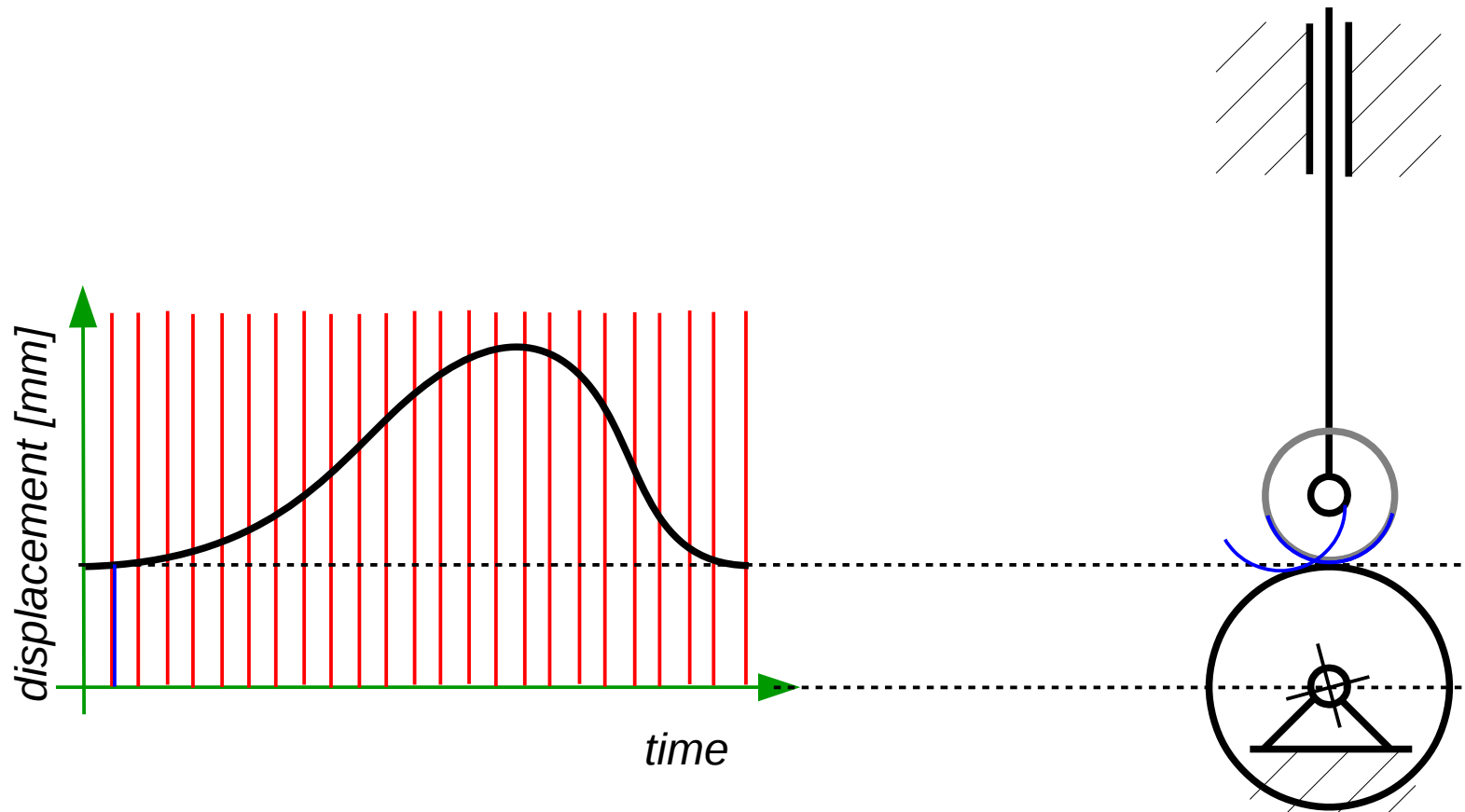

Synthesis of cam-follower mechanisms

Graphical method

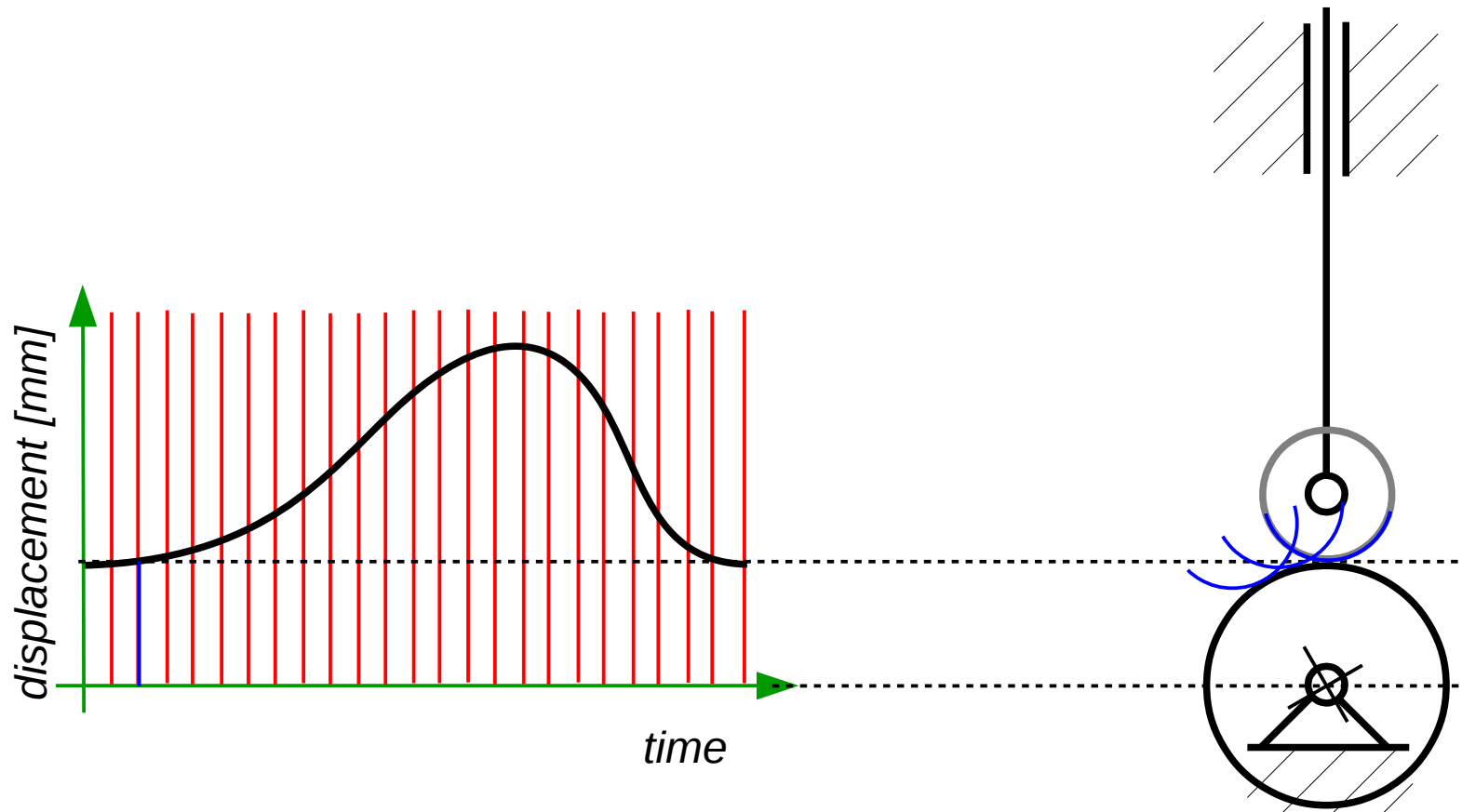

Synthesis of cam-follower mechanisms

Graphical method

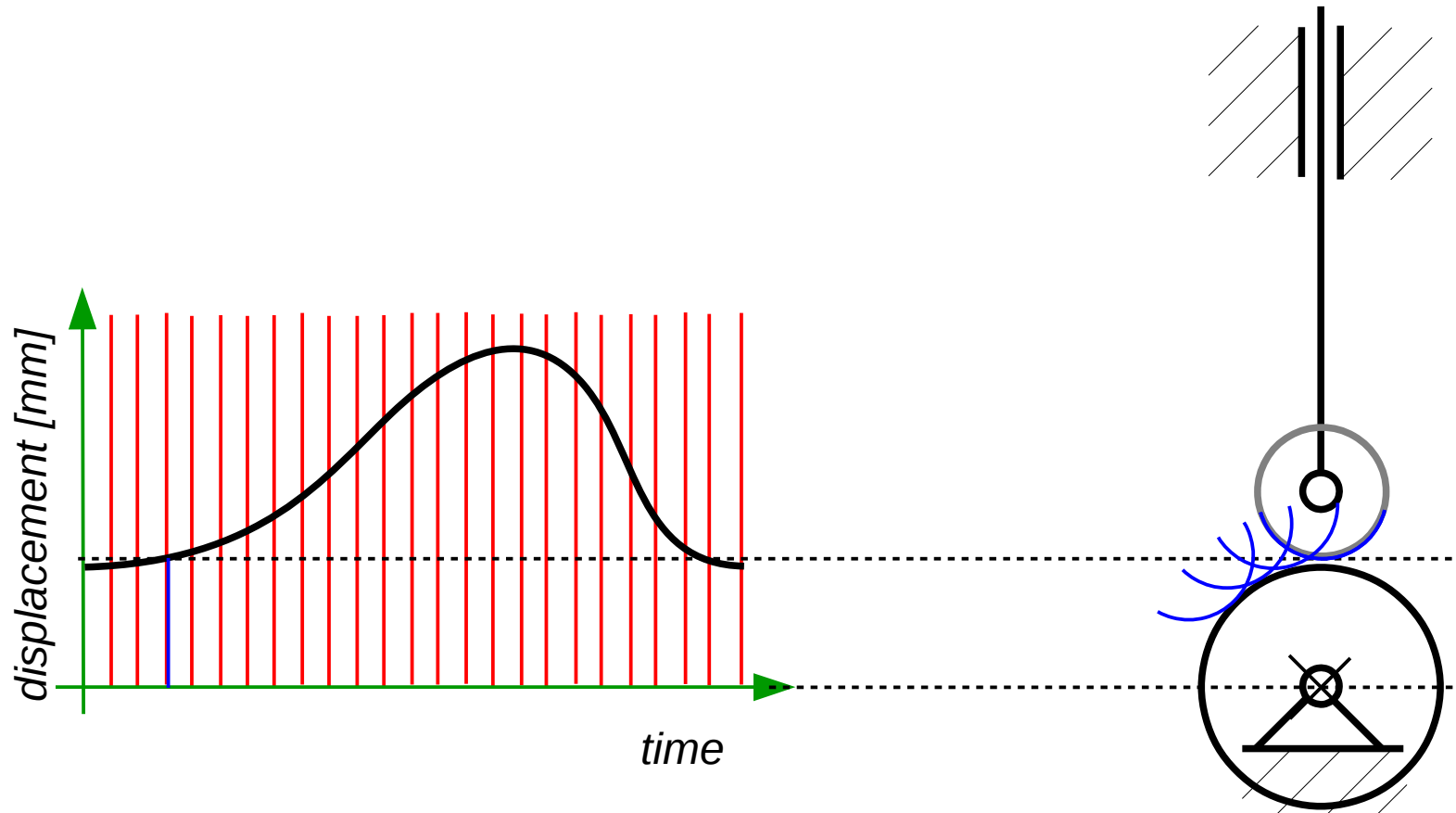

Synthesis of cam-follower mechanisms

Graphical method

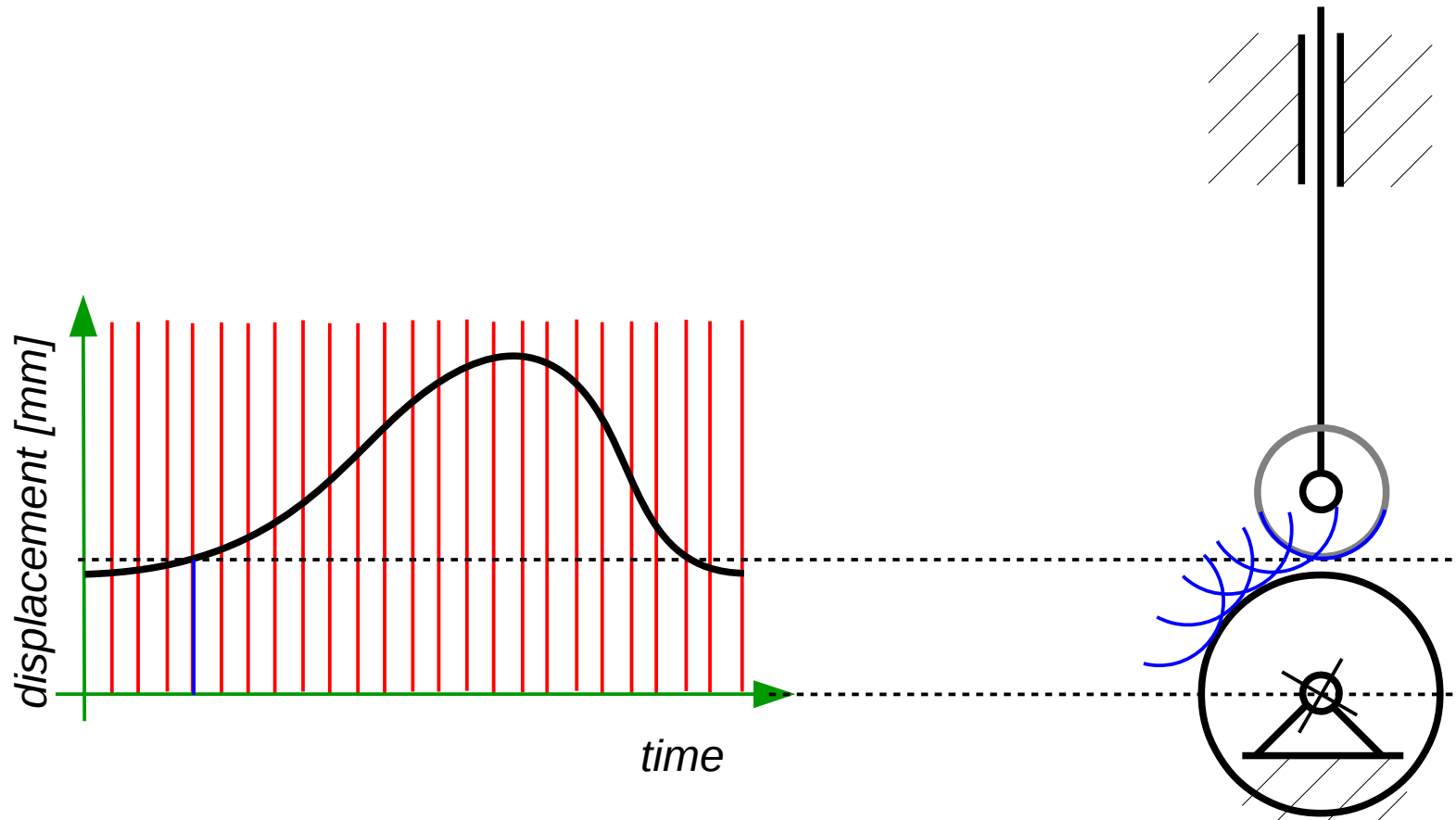

Synthesis of cam-follower mechanisms

Graphical method

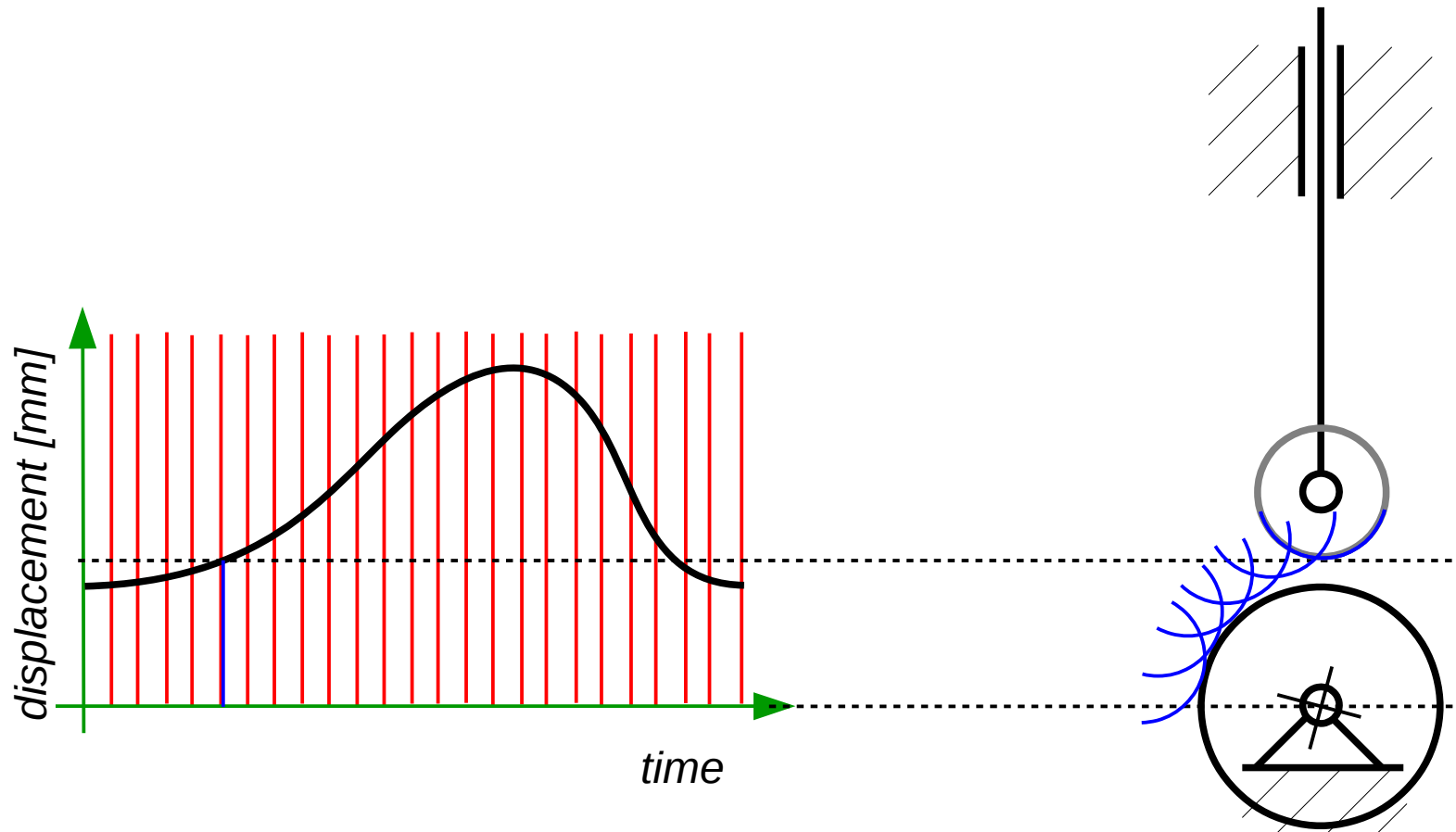

Synthesis of cam-follower mechanisms

Graphical method

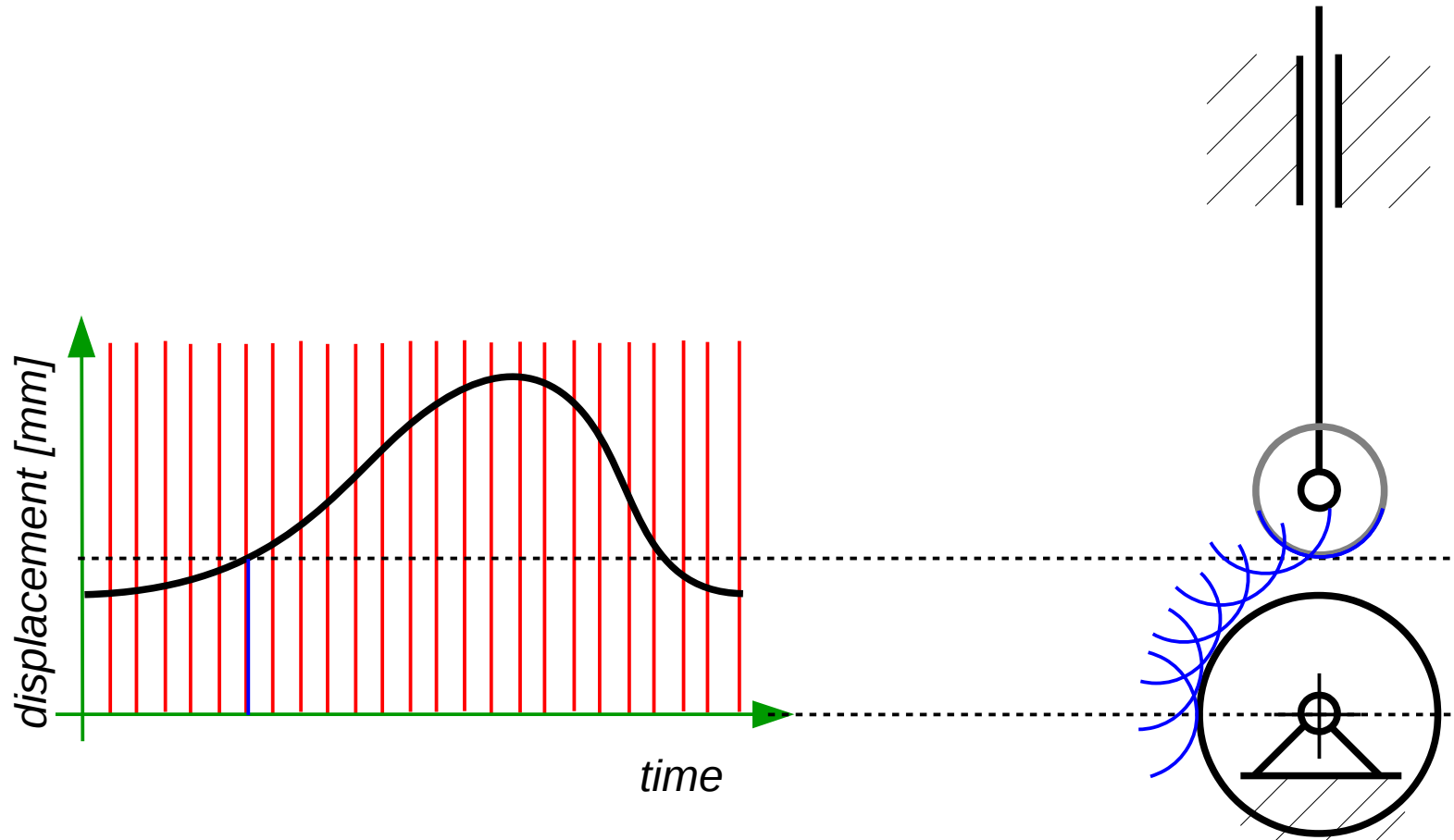

Synthesis of cam-follower mechanisms

Graphical method

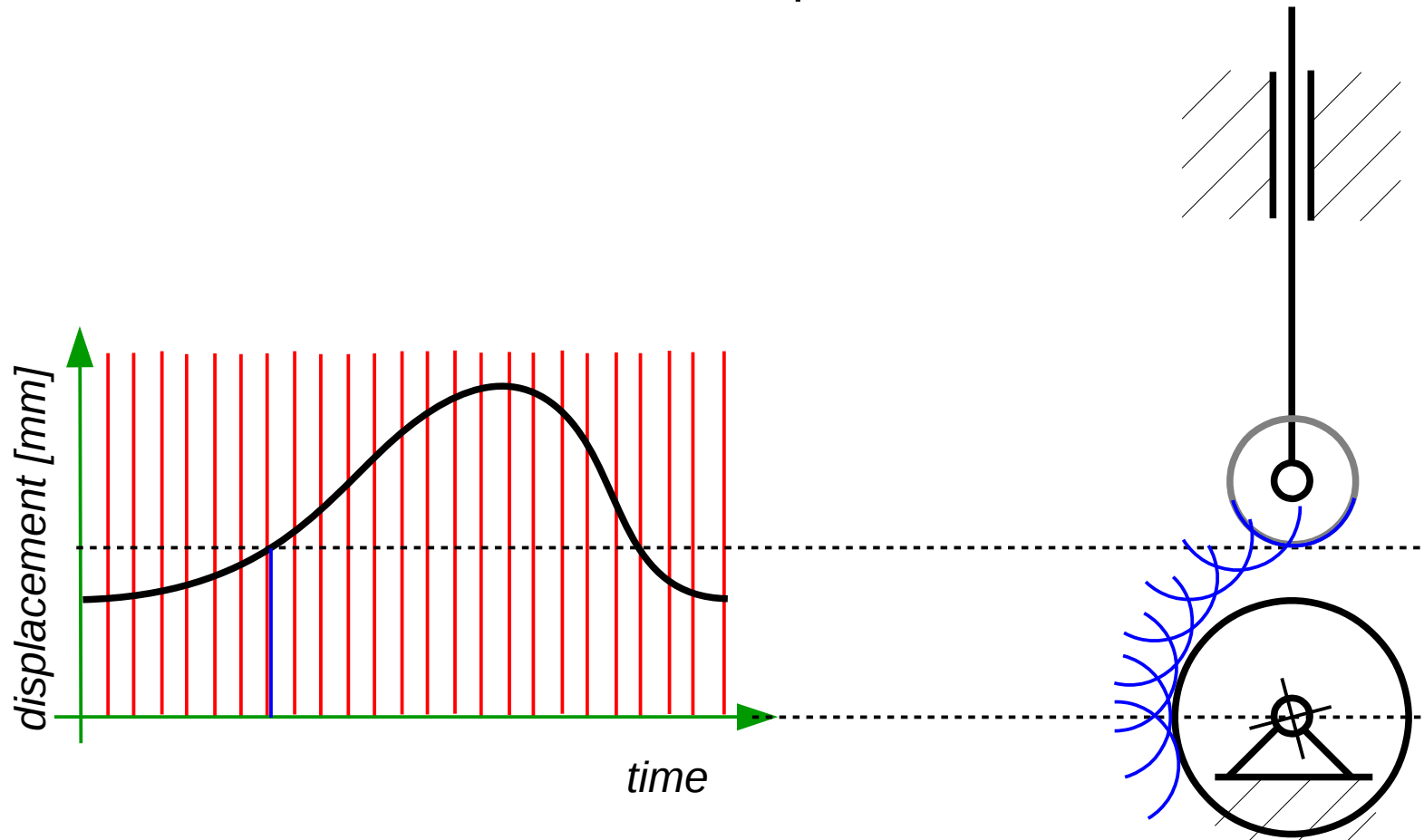

Synthesis of cam-follower mechanisms

Graphical method

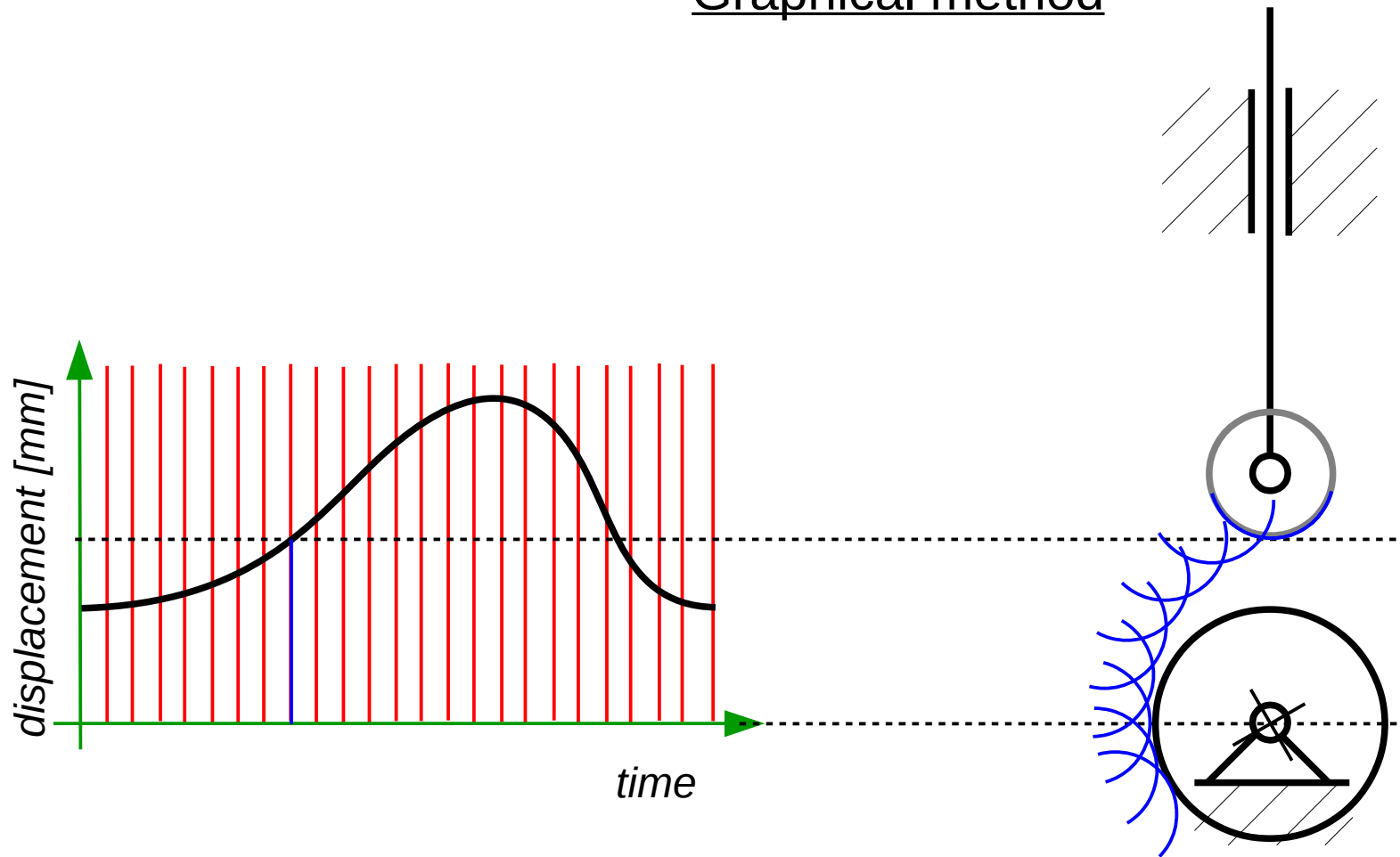

Synthesis of cam-follower mechanisms

Graphical method

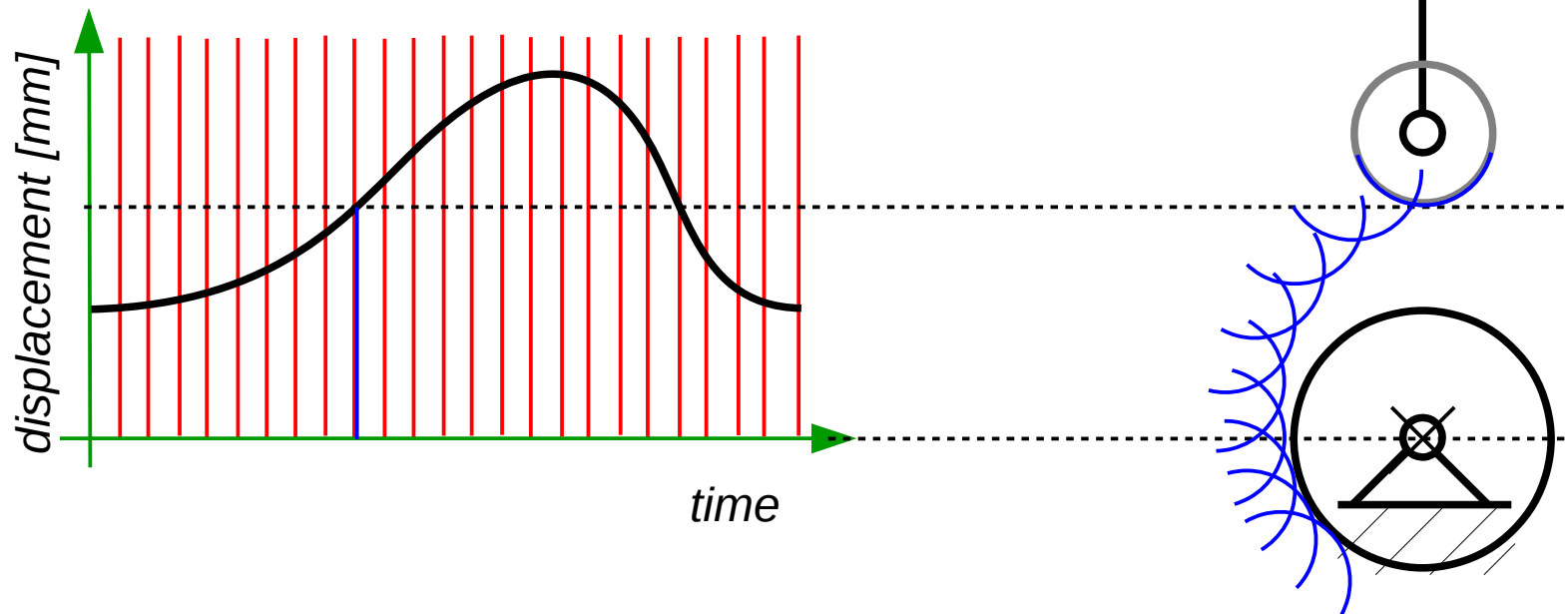

Synthesis of cam-follower mechanisms

Graphical method

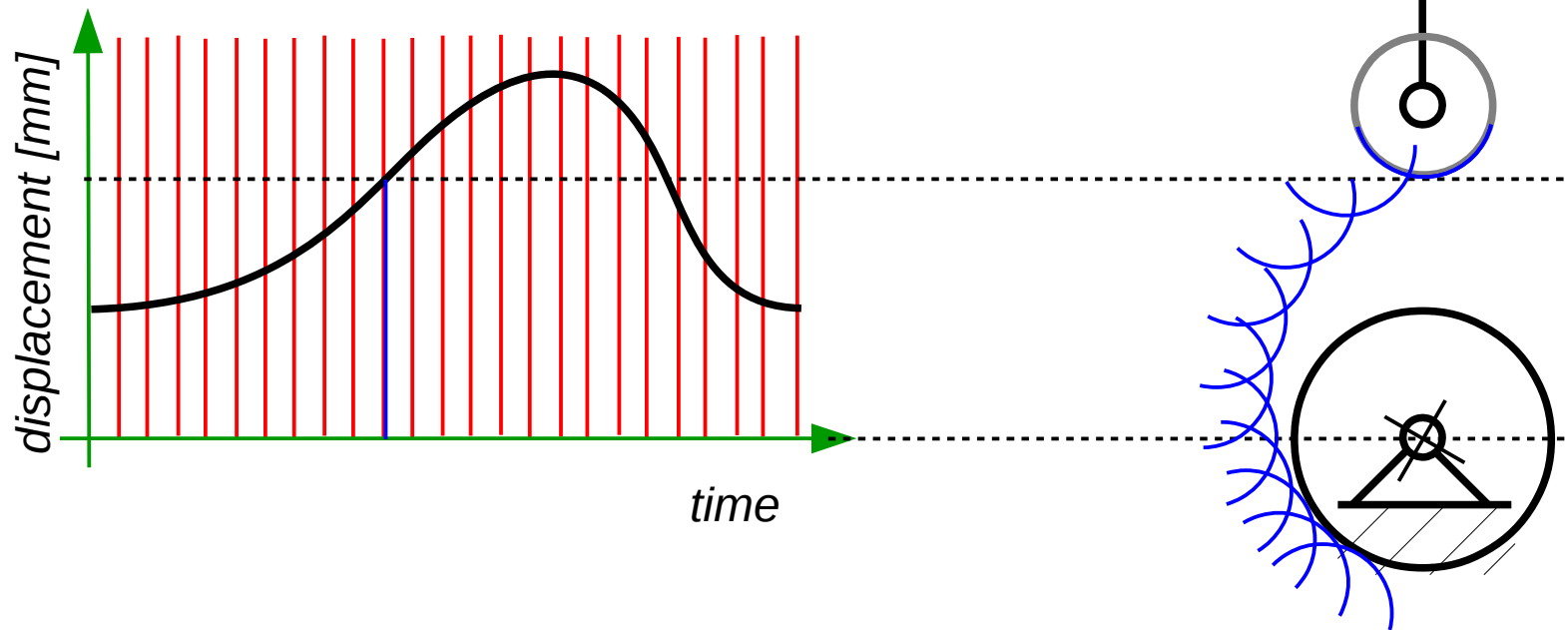

Synthesis of cam-follower mechanisms

Graphical method

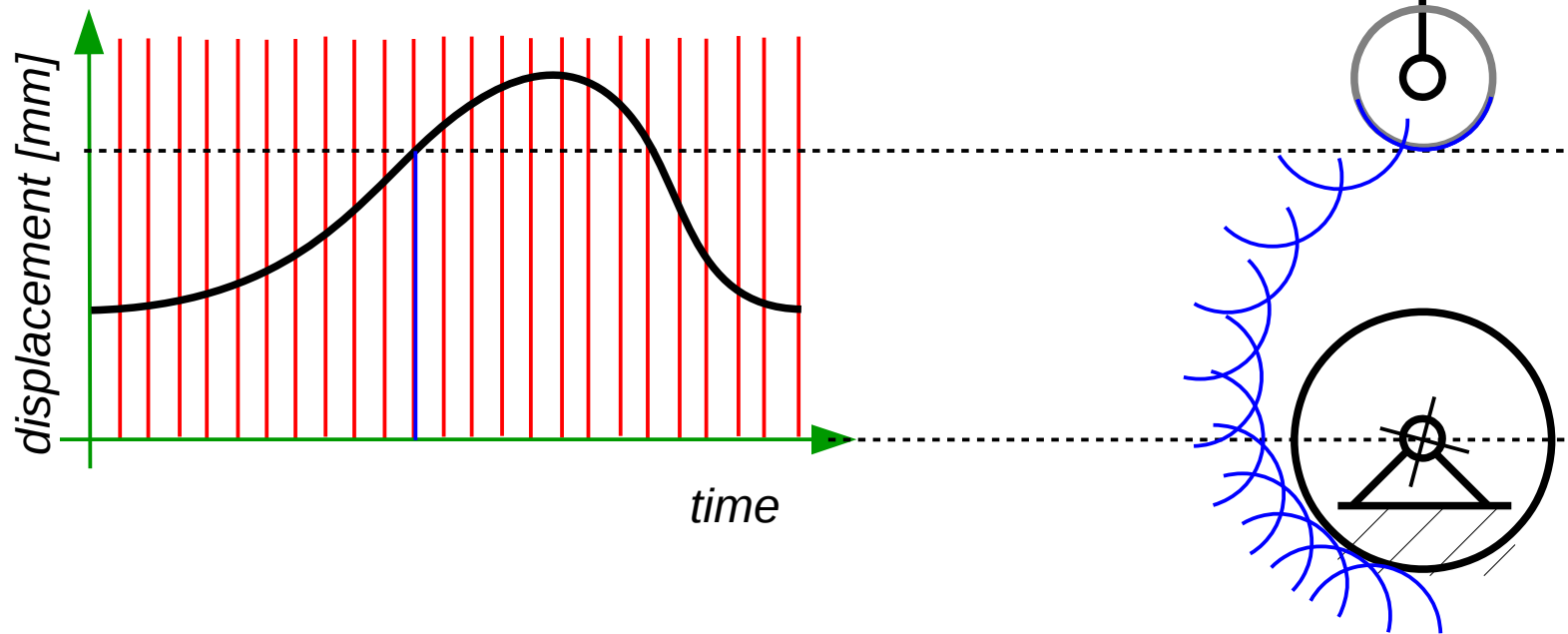

Synthesis of cam-follower mechanisms

Graphical method

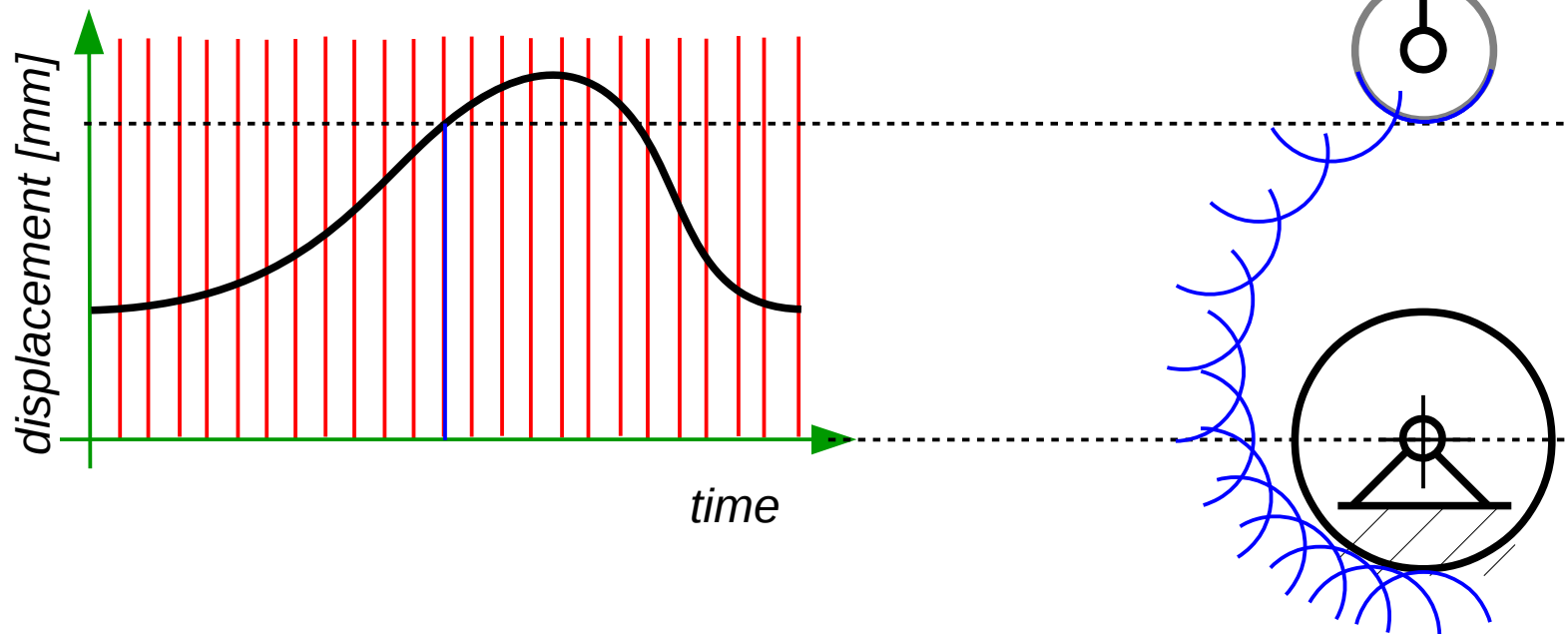

Synthesis of cam-follower mechanisms

Graphical method

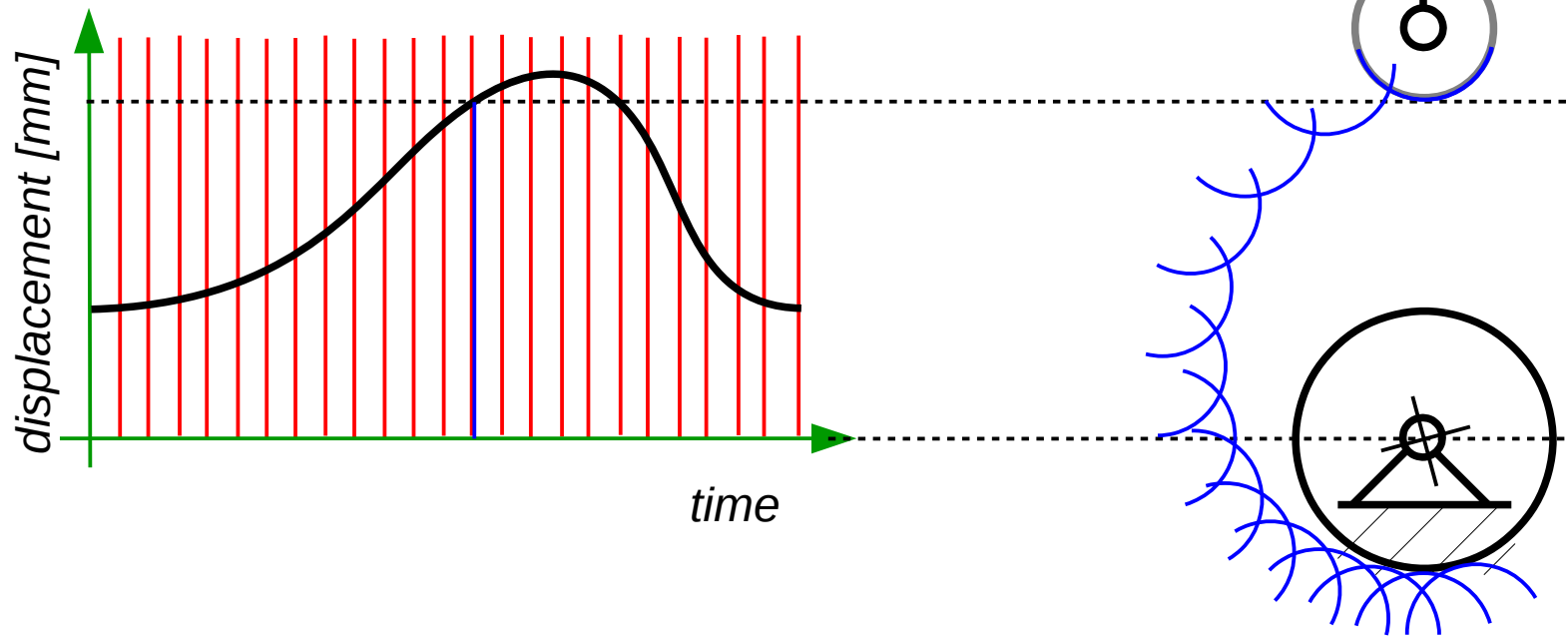

Synthesis of cam-follower mechanisms

Graphical method

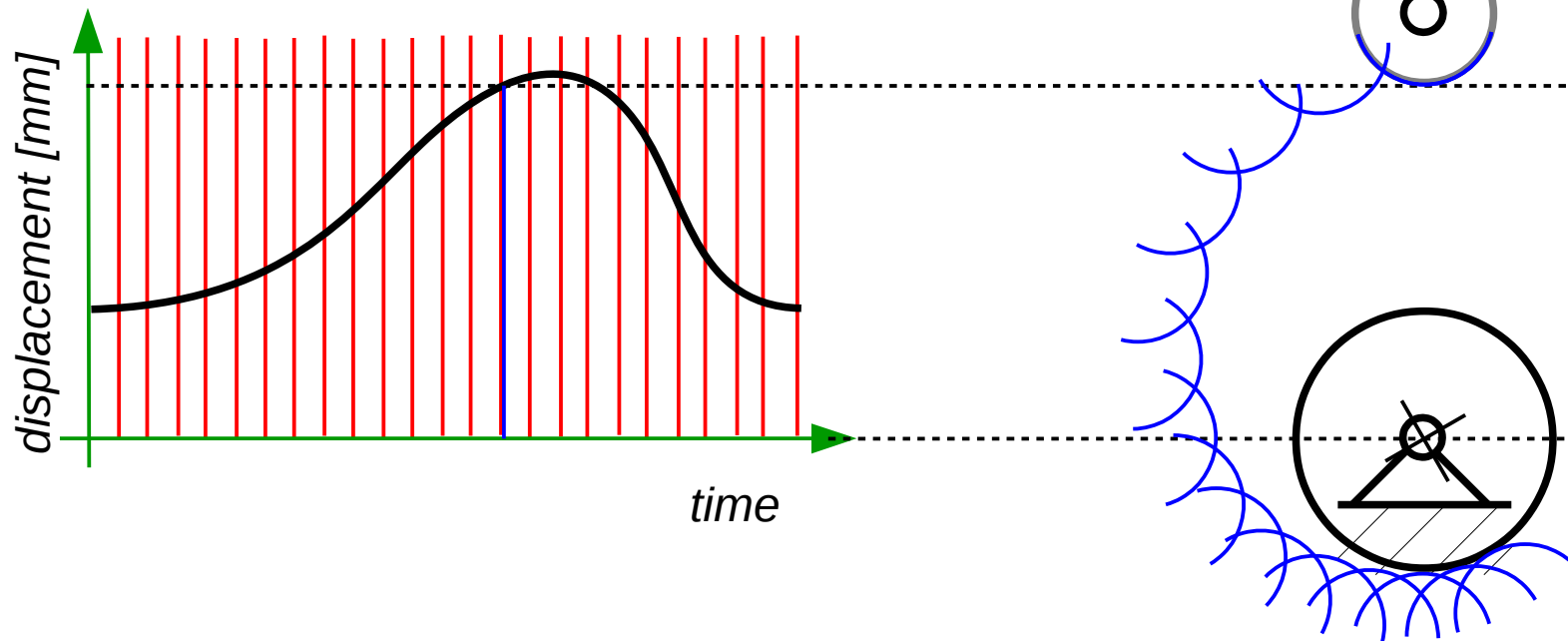

Synthesis of cam-follower mechanisms

Graphical method

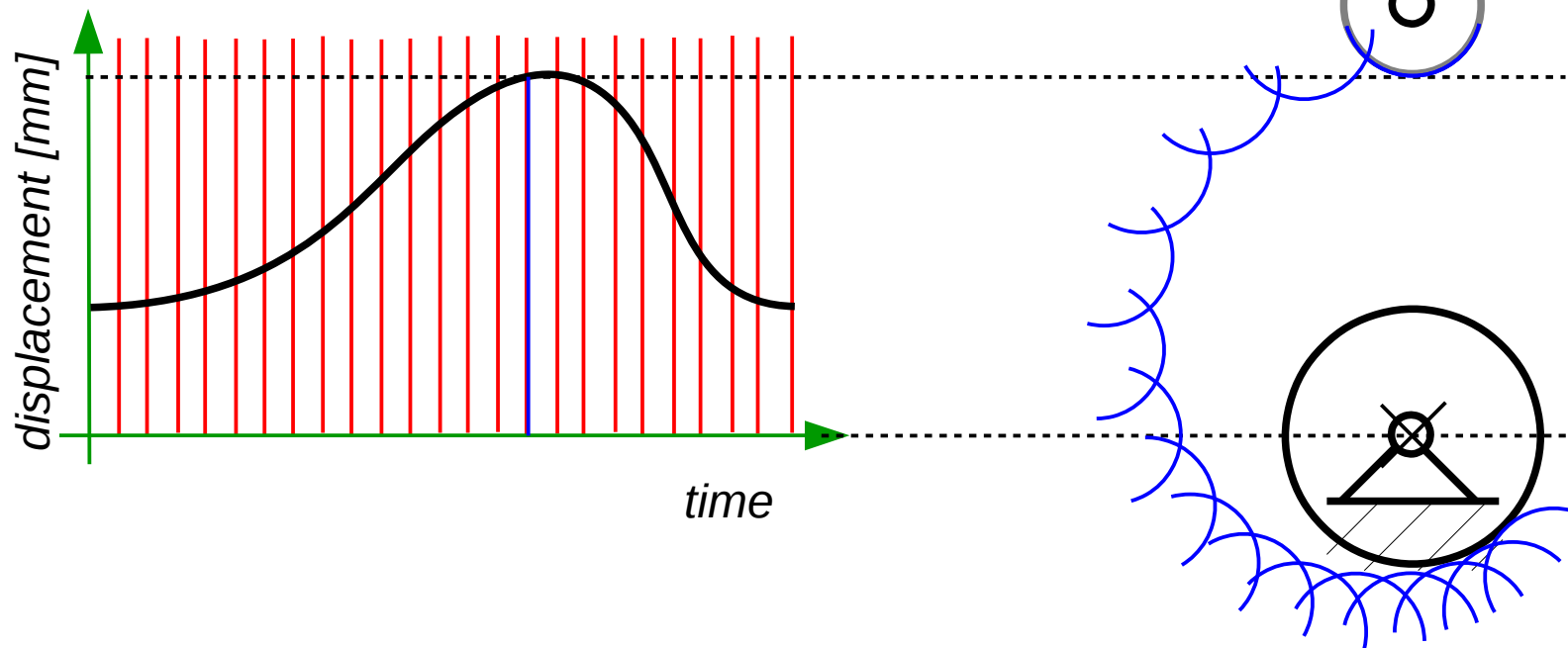

Synthesis of cam-follower mechanisms

Graphical method

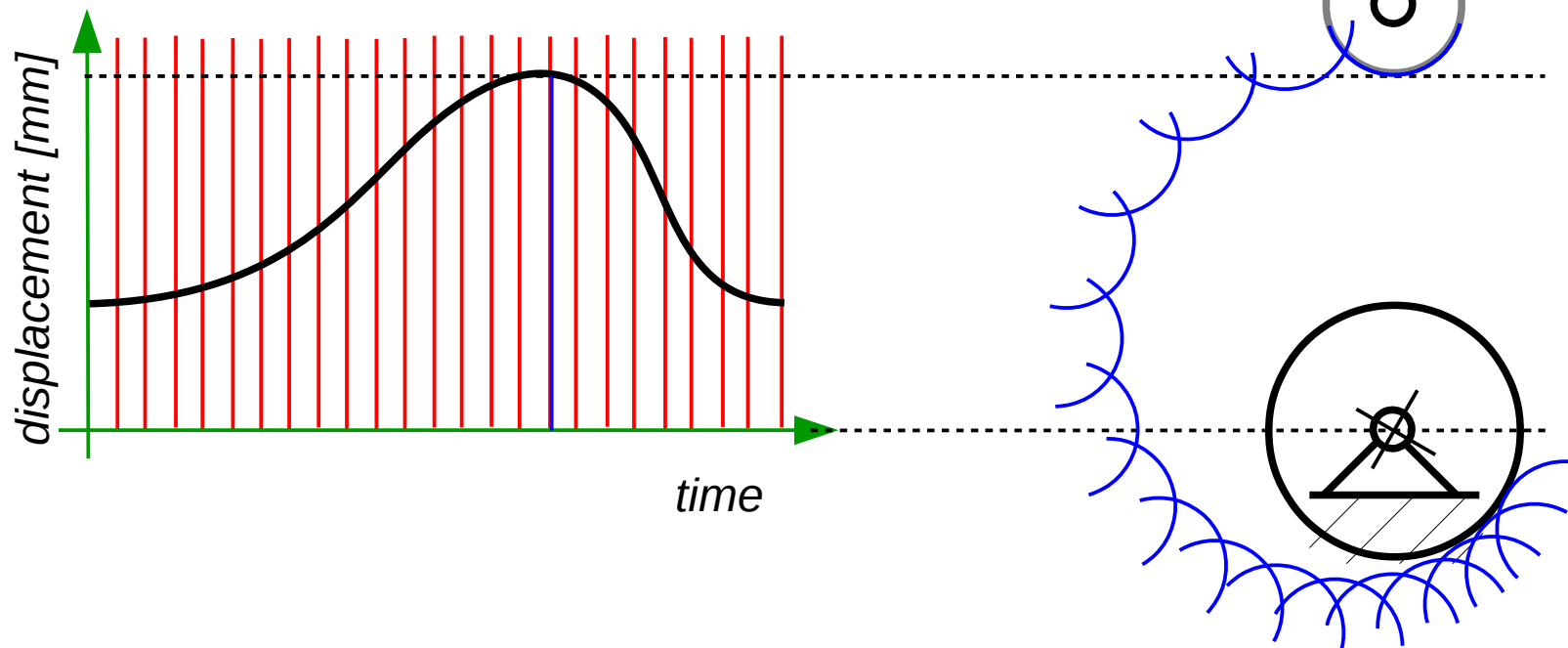

Synthesis of cam-follower mechanisms

Graphical method

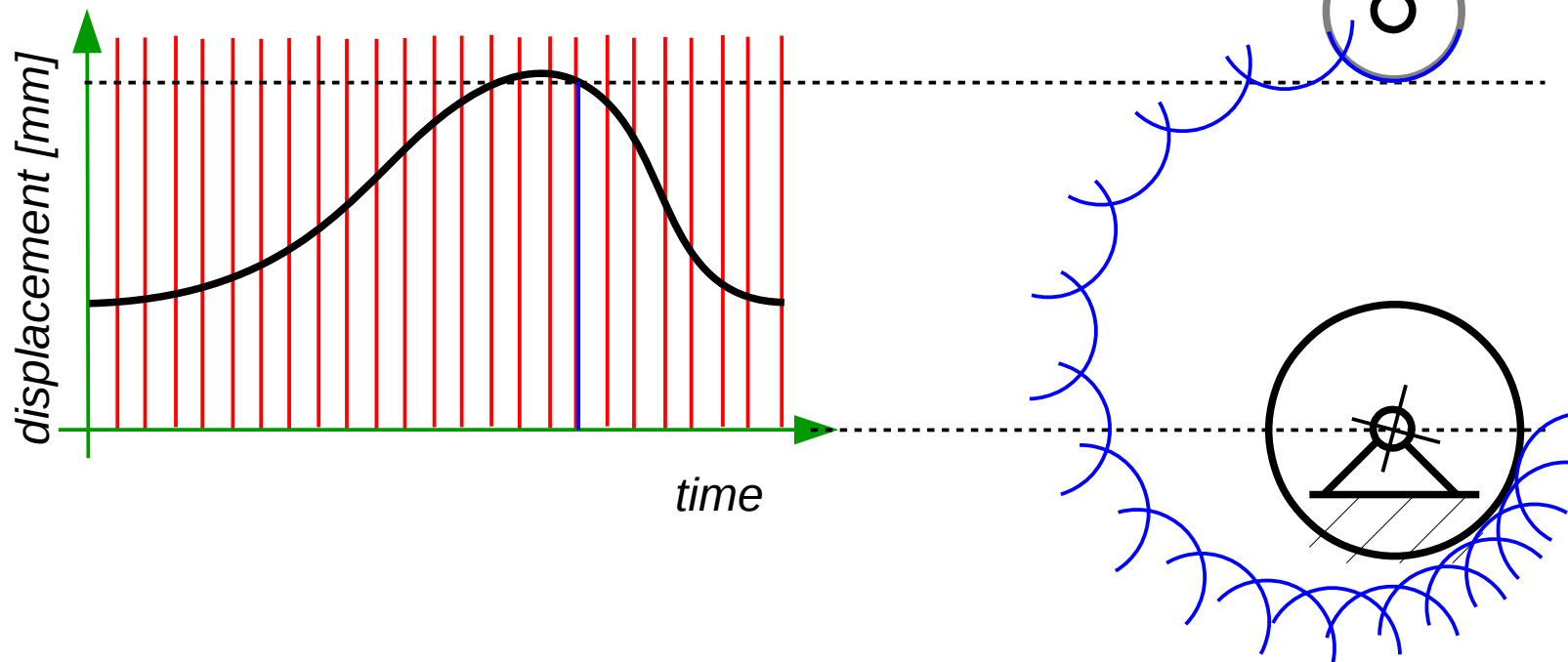

Synthesis of cam-follower mechanisms

Graphical method

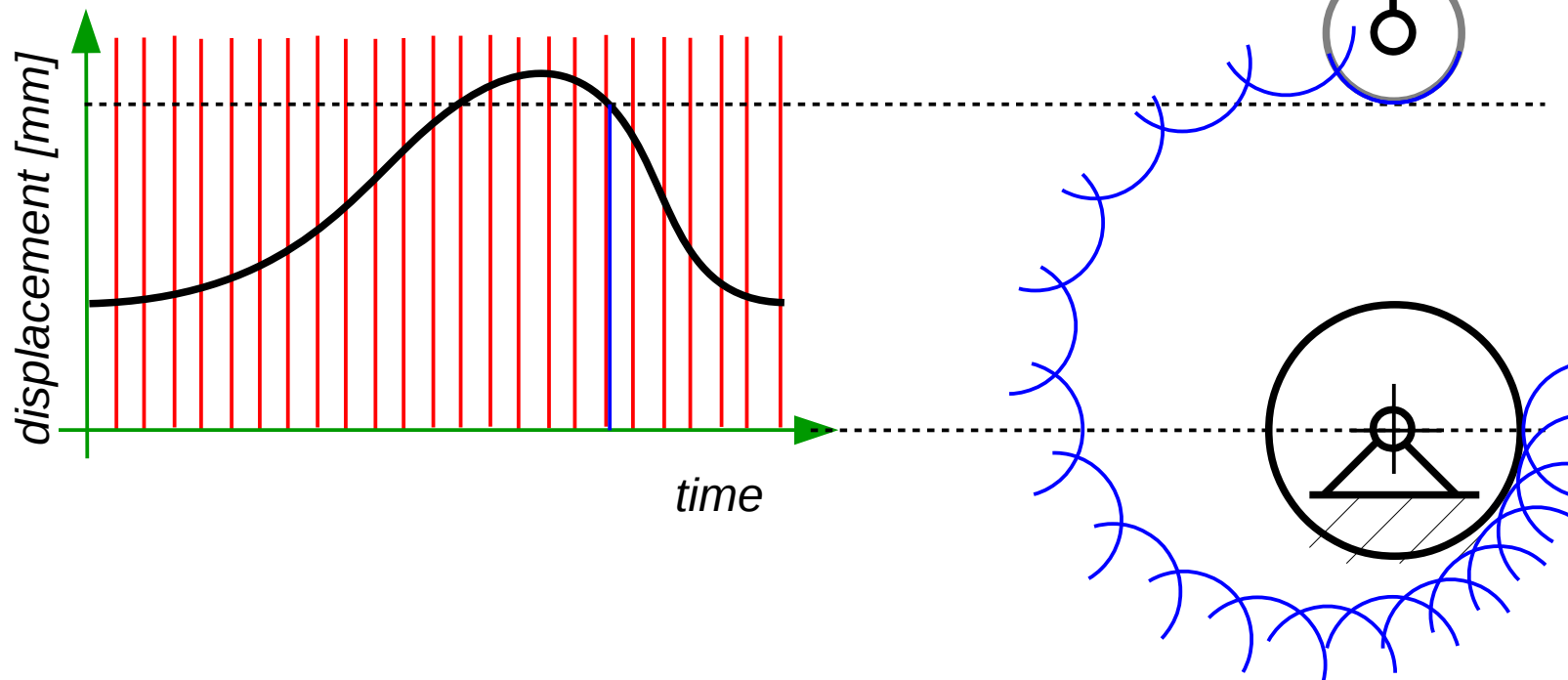

Synthesis of cam-follower mechanisms

Graphical method

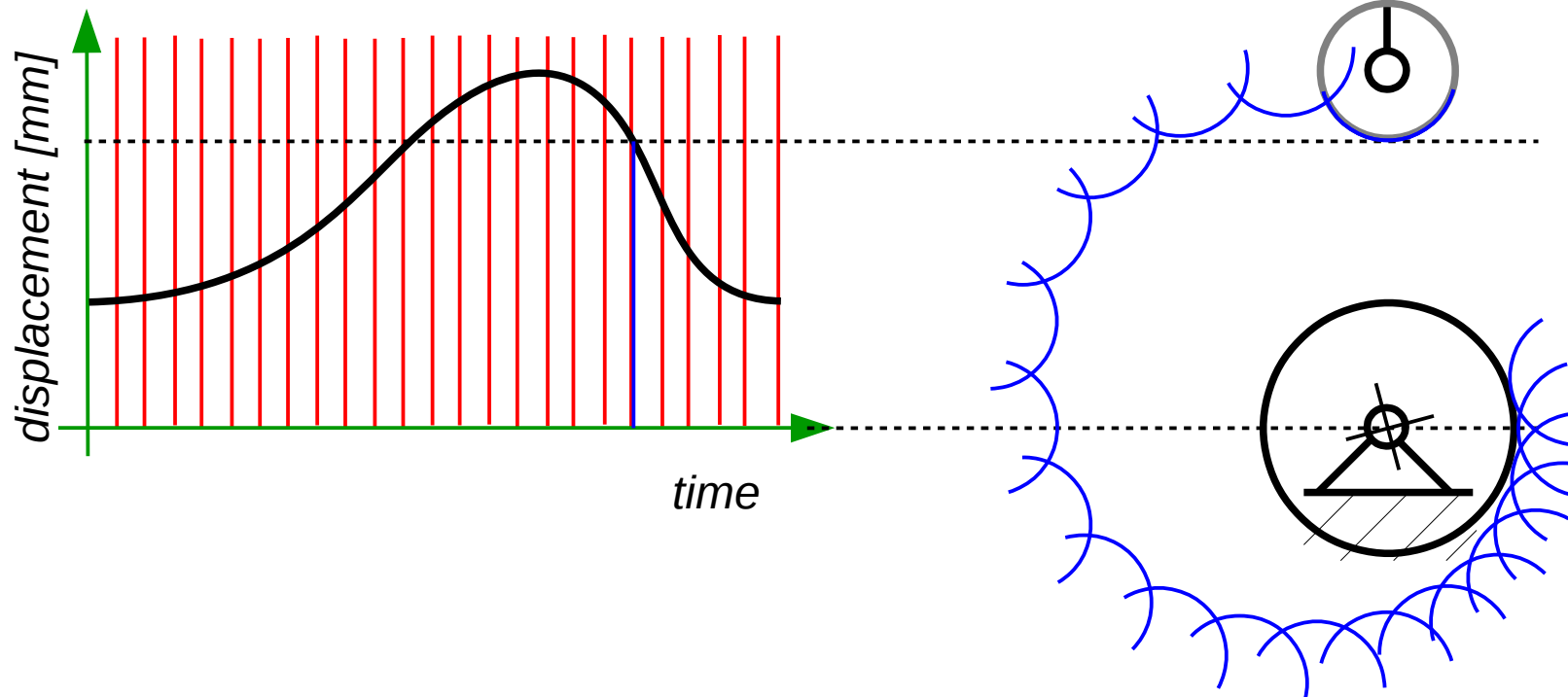

Synthesis of cam-follower mechanisms

Graphical method

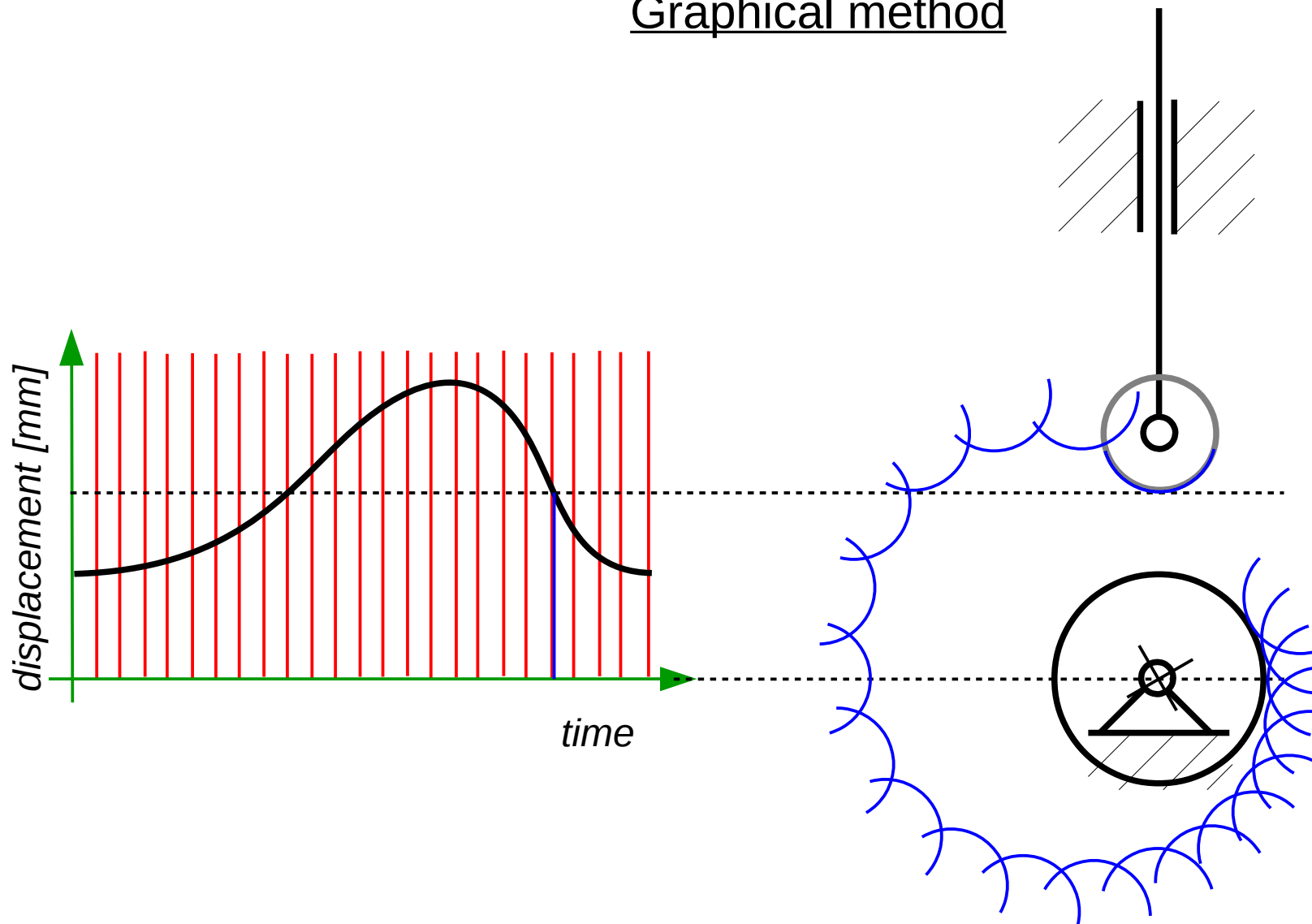

Synthesis of cam-follower mechanisms

Graphical method

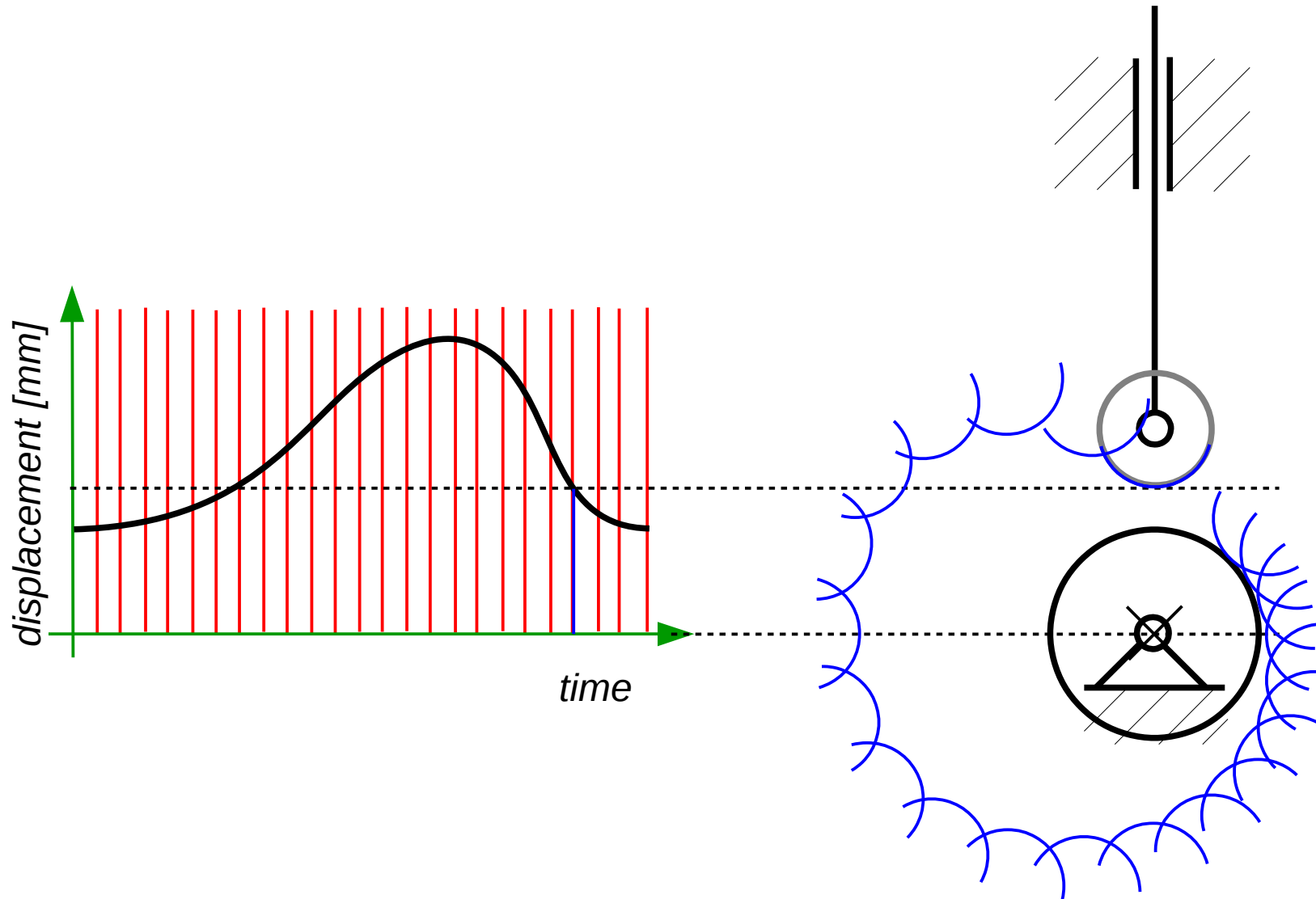

Synthesis of cam-follower mechanisms

Graphical method

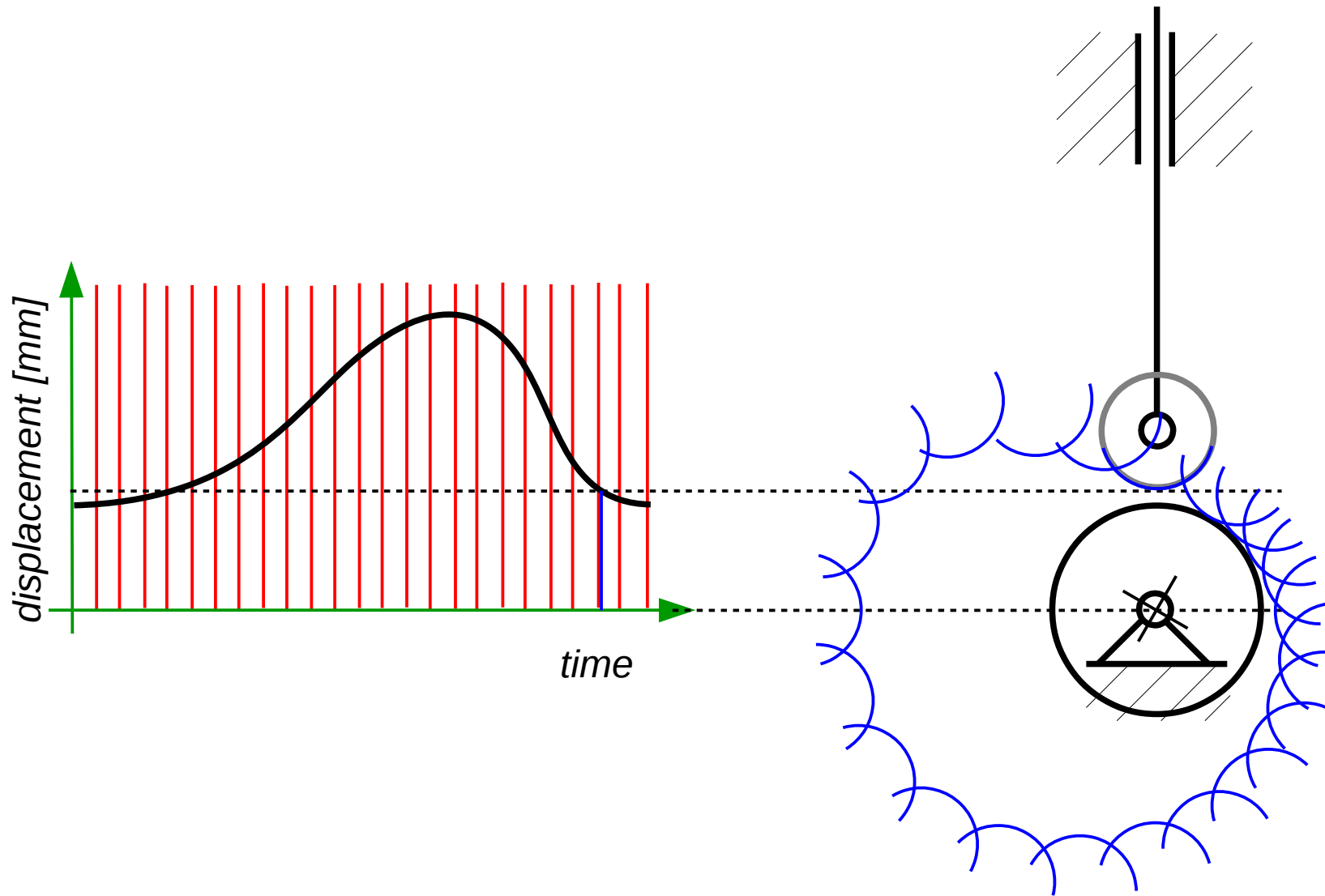

Synthesis of cam-follower mechanisms

Graphical method

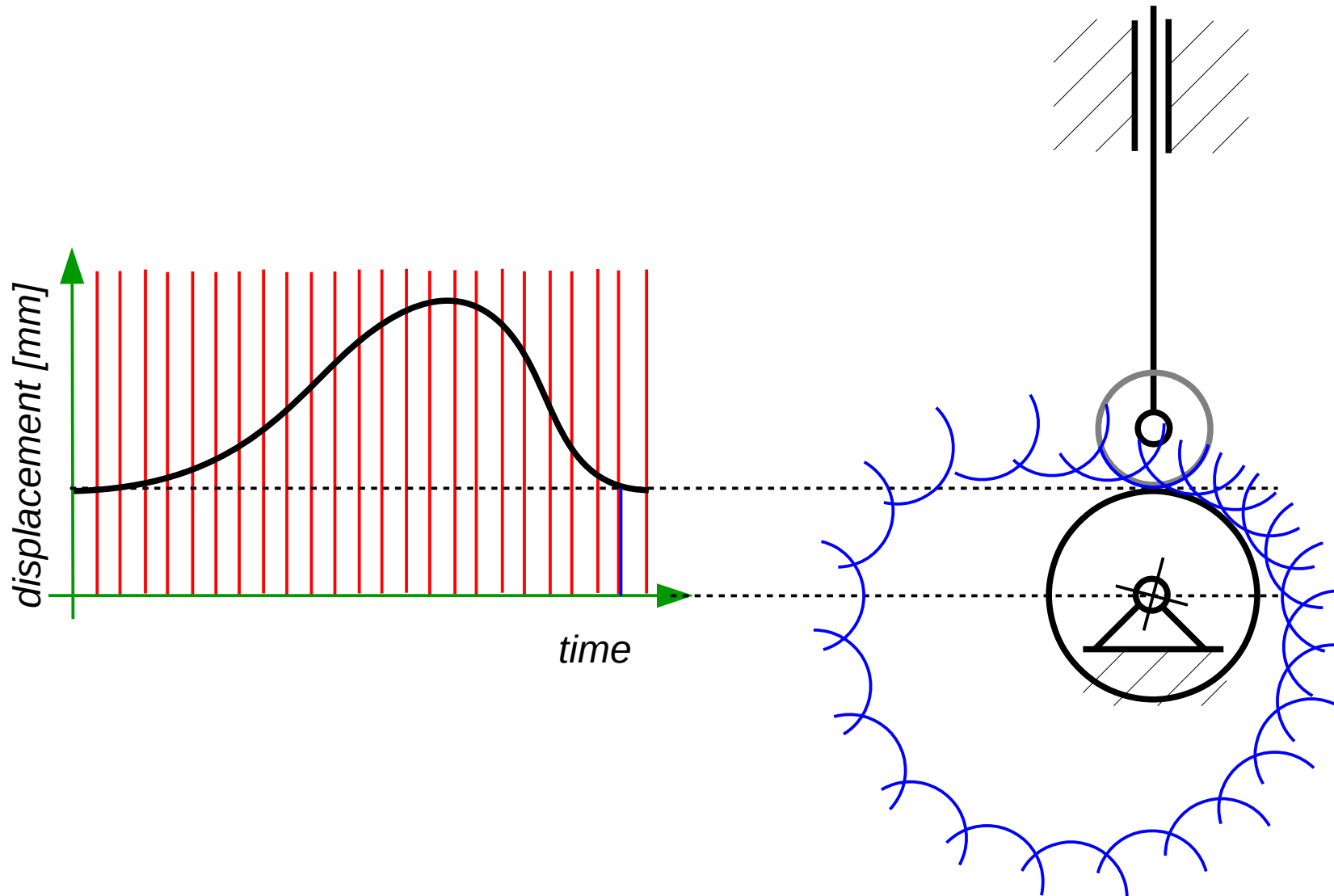

Synthesis of cam-follower mechanisms

Graphical method

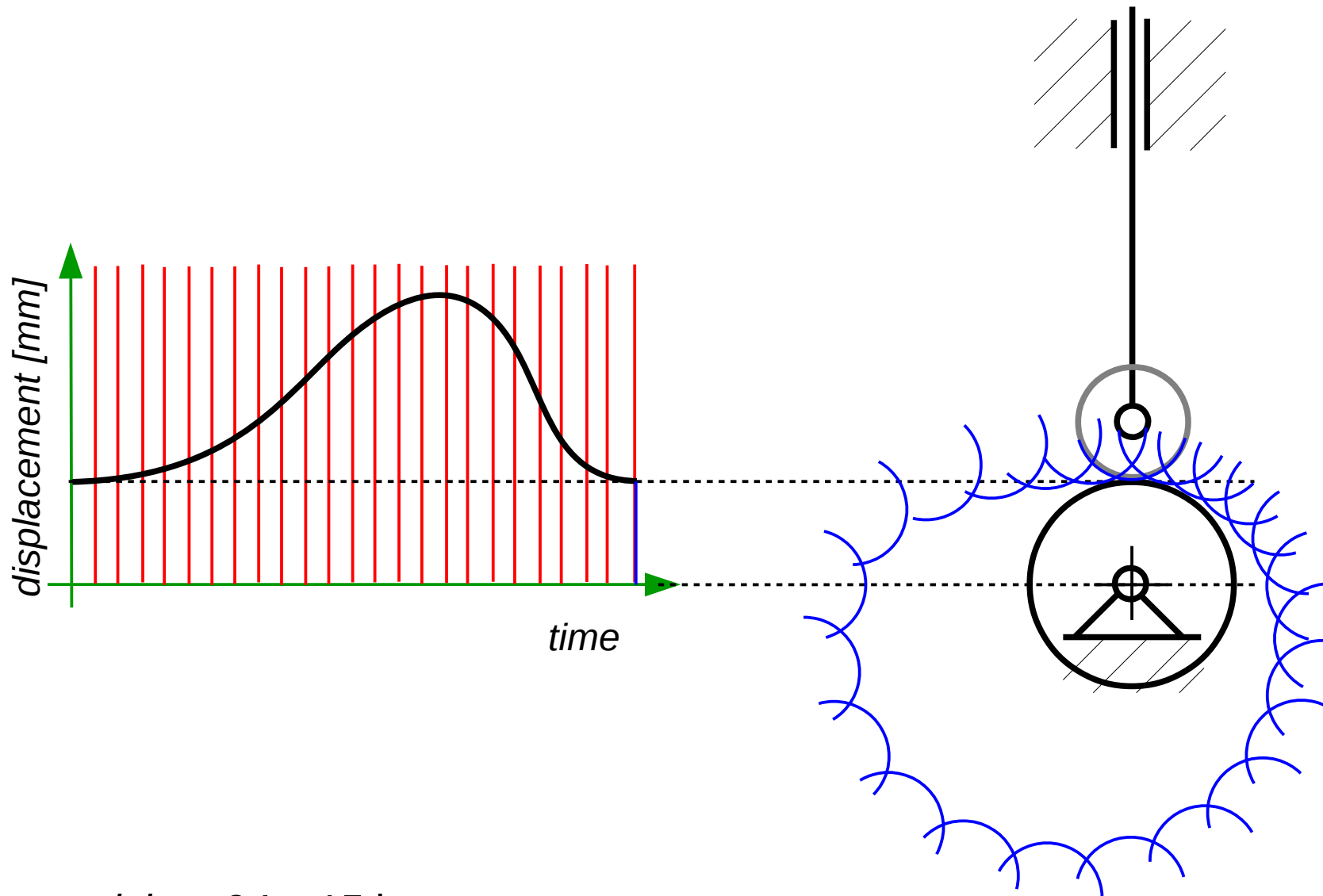

precision: 24 x 15deg

Synthesis of cam-follower mechanisms

Graphical method

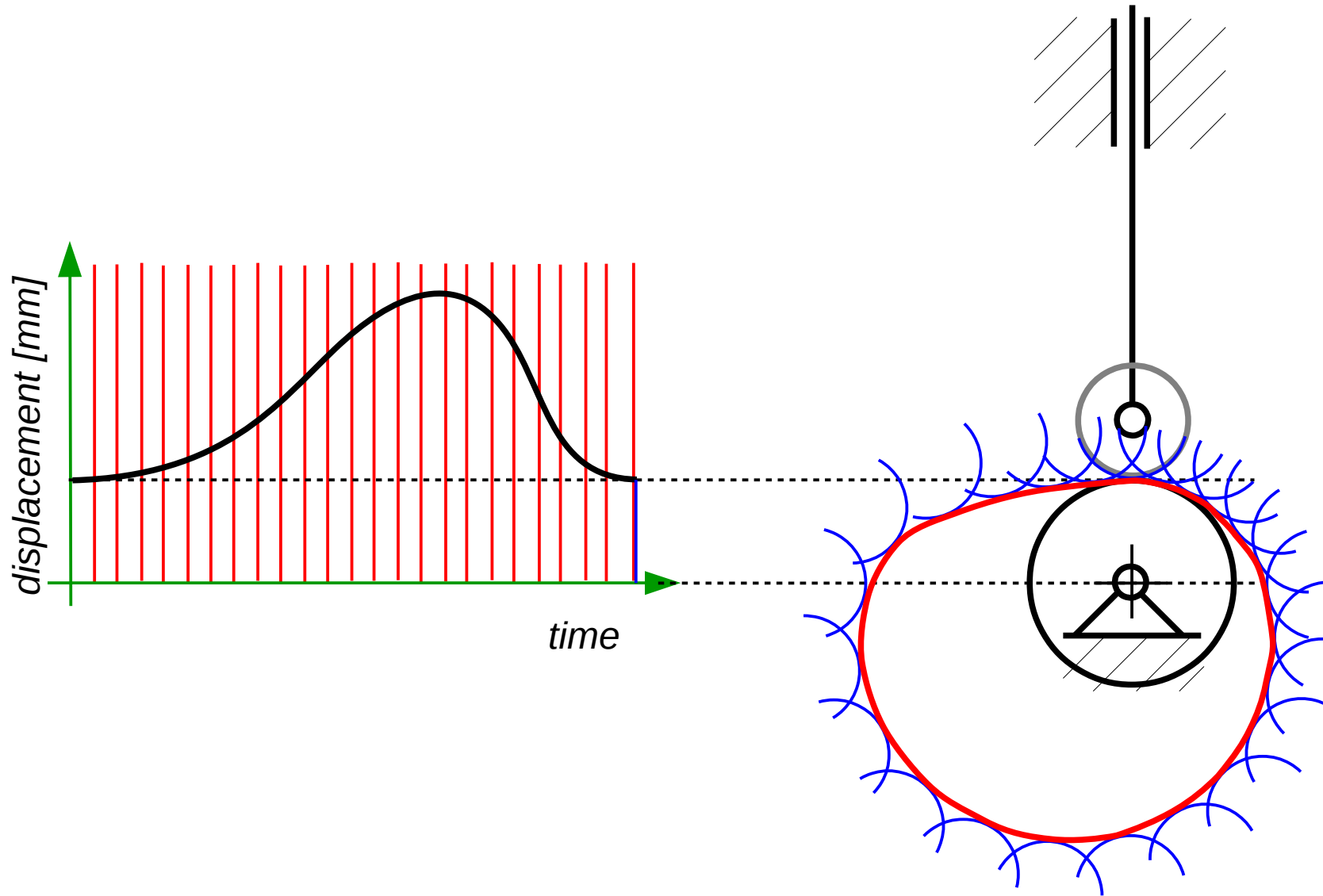

Synthesis of cam-follower mechanisms

Graphical method

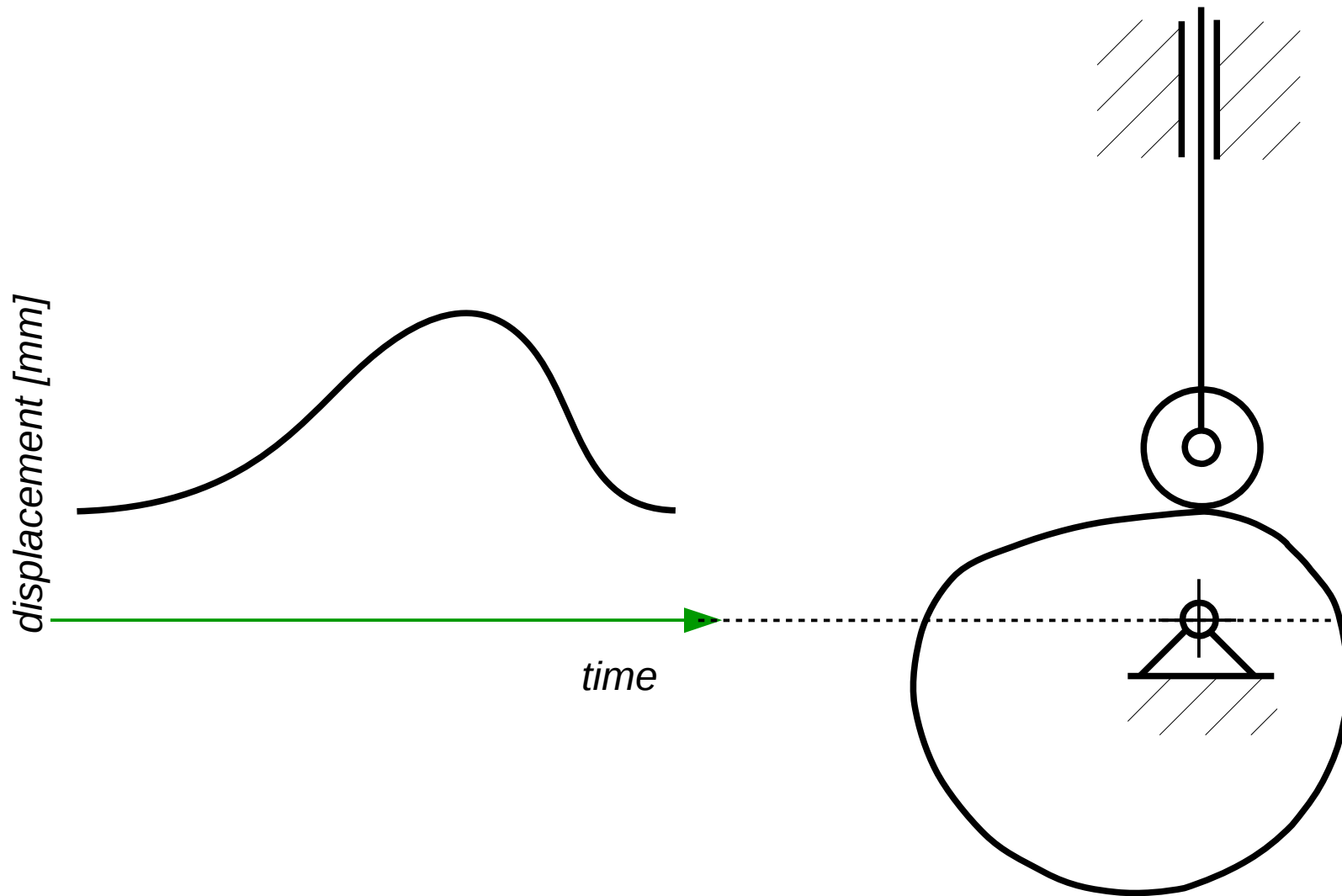

Synthesis of cam-follower mechanisms

Analytical method

Synthesis of cam-follower mechanisms

Analytical method

For a given function of velocity or acceleration, function of a follower displacement can be found by integration.

Follower displacement as a function of cam angle could be used to obtain cam outline directly (or after change of coordinates).

For a knife-edge follower we will obtain exact real displacement.
For a roller-ended follower some errors are possible.

Roller-ended follower give us limitation of a maximum velocity (there is a relation between roller radius and cam size).

Usually we are designing symmetric and smooth cams.

Synthesis of cam-follower mechanisms

Analytical method – example

Design profile of a cam cooperating with eccentric knife-edge follower to obtain constant acceleration of uplift and downlift with constant angular velocity.

Synthesis of cam-follower mechanisms

Analytical method – example

Design profile of a cam cooperating with eccentric knife-edge follower to obtain constant acceleration of uplift and downlift with constant angular velocity.

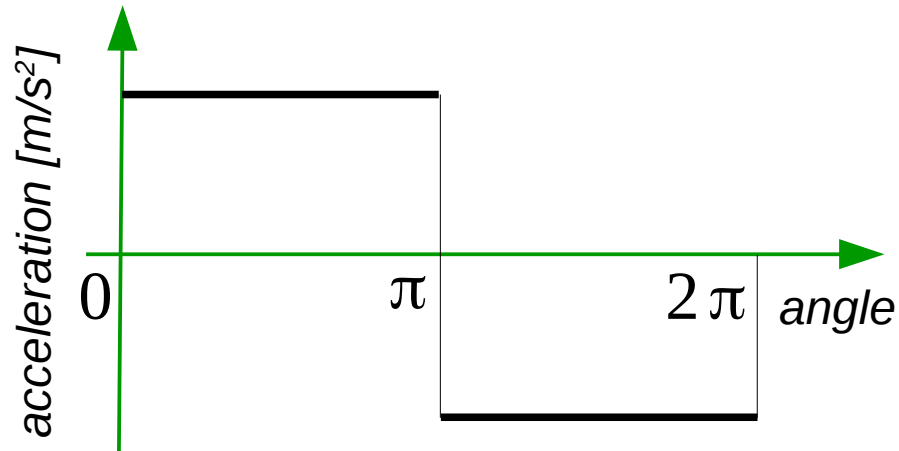

Synthesis of cam-follower mechanisms

Analytical method – example

Design profile of a cam cooperating with eccentric knife-edge follower to obtain constant acceleration of uplift and downlift with constant angular velocity.

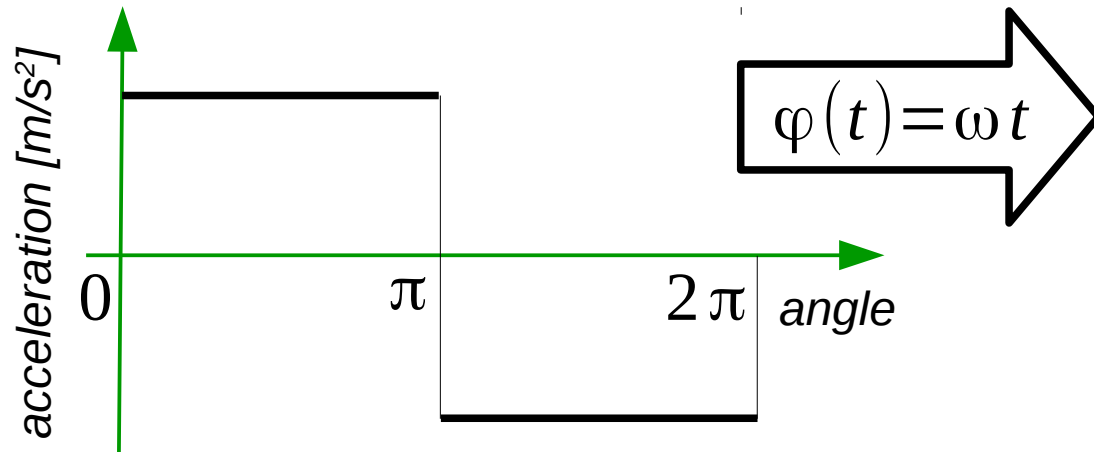

Synthesis of cam-follower mechanisms

Analytical method – example

Design profile of a cam cooperating with eccentric knife-edge follower to obtain constant acceleration of uplift and downlift with constant angular velocity.

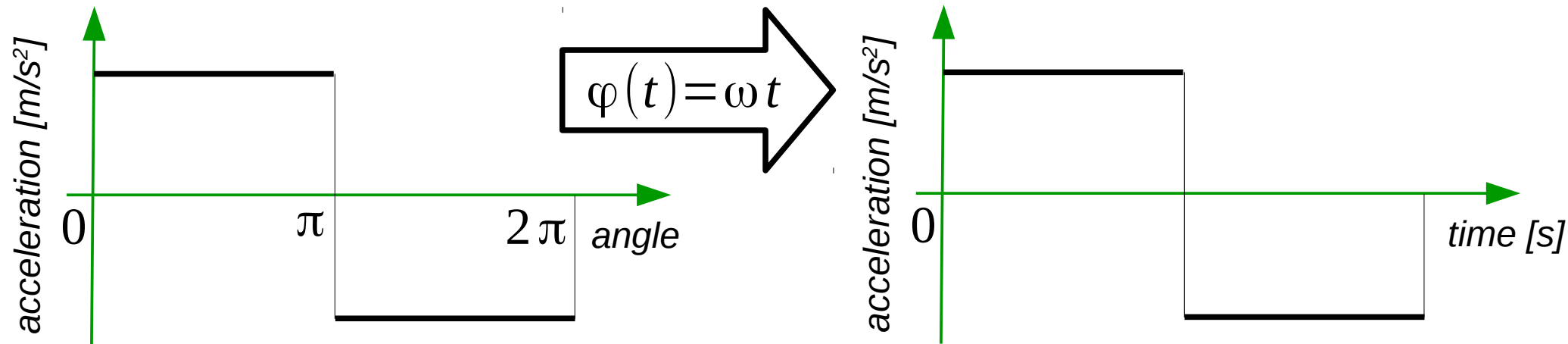

Synthesis of cam-follower mechanisms

Analytical method – example

Design profile of a cam cooperating with eccentric knife-edge follower to obtain constant acceleration of uplift and downlift with constant angular velocity.

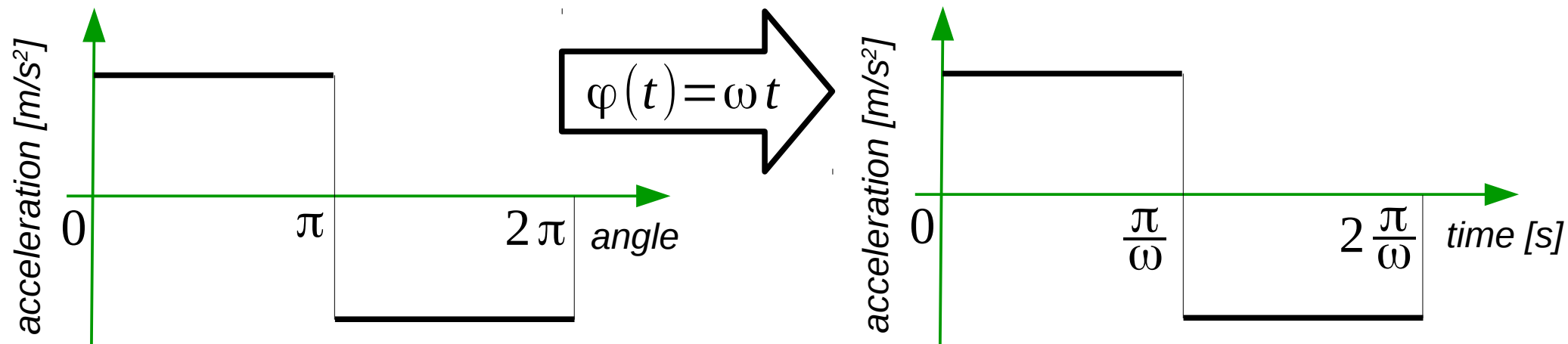

Synthesis of cam-follower mechanisms

Analytical method – example

Design profile of a cam cooperating with eccentric knife-edge follower to obtain constant acceleration of uplift and downlift with constant angular velocity.

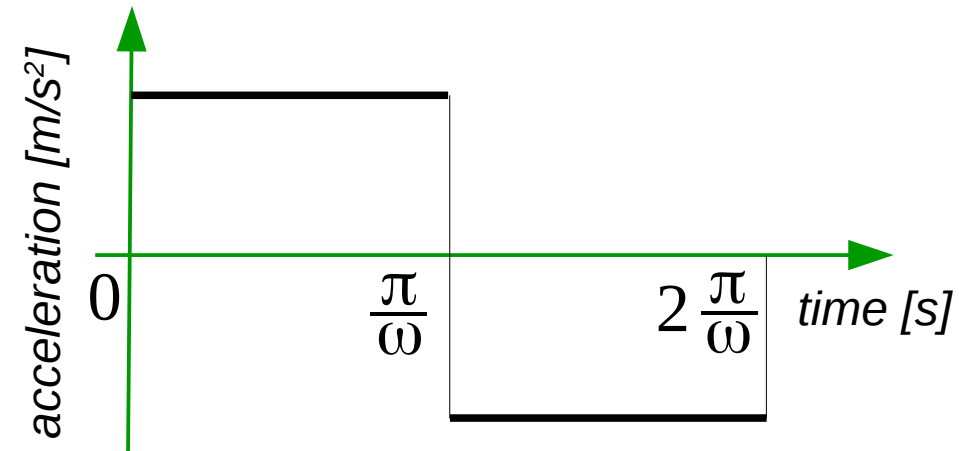

Synthesis of cam-follower mechanisms

Analytical method – example

Design profile of a cam cooperating with eccentric knife-edge follower to obtain constant acceleration of uplift and downlift with constant angular velocity.

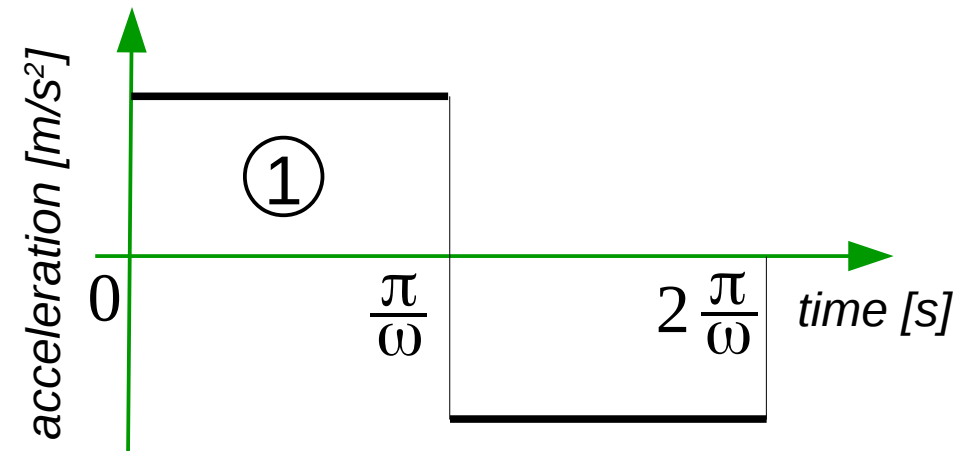

$$a_1 = a_0$$

$$v_1(t) = a_0 t + C_1$$

$$h_1(t) = \frac{a_0 t^2}{2} + C_1 t + C_2$$

Synthesis of cam-follower mechanisms

Analytical method – example

Design profile of a cam cooperating with eccentric knife-edge follower to obtain constant acceleration of uplift and downlift with constant angular velocity.

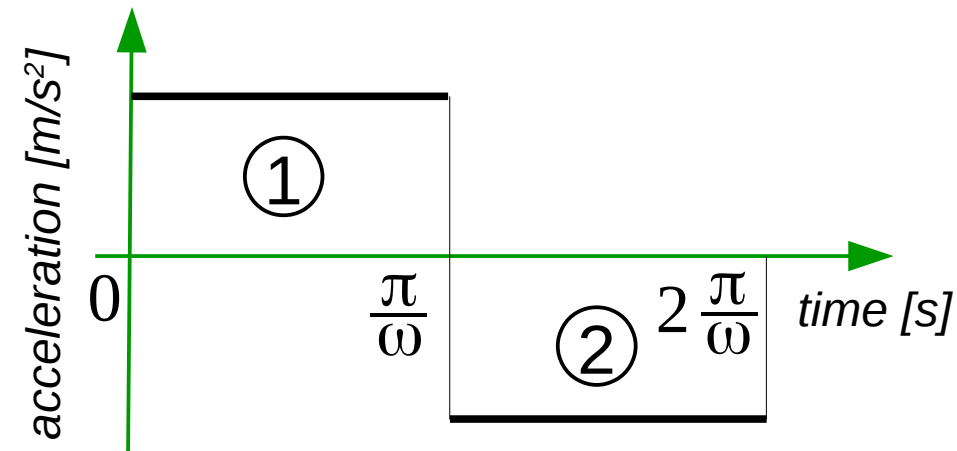

$$a_1 = a_0$$

$$v_1(t) = a_0 t + C_1$$

$$h_1(t) = \frac{a_0 t^2}{2} + C_1 t + C_2$$

$$a_2 = -a_0$$

$$v_2(t) = -a_0 t + C_3$$

$$h_2(t) = \frac{-a_0 t^2}{2} + C_3 t + C_4$$

Synthesis of cam-follower mechanisms

Analytical method – example

Design profile of a cam cooperating with eccentric knife-edge follower to obtain constant acceleration of uplift and downlift with constant angular velocity.

Cam base-radius

$$h_1(t=0) = h_2(t=2\frac{\pi}{\omega}) = R$$

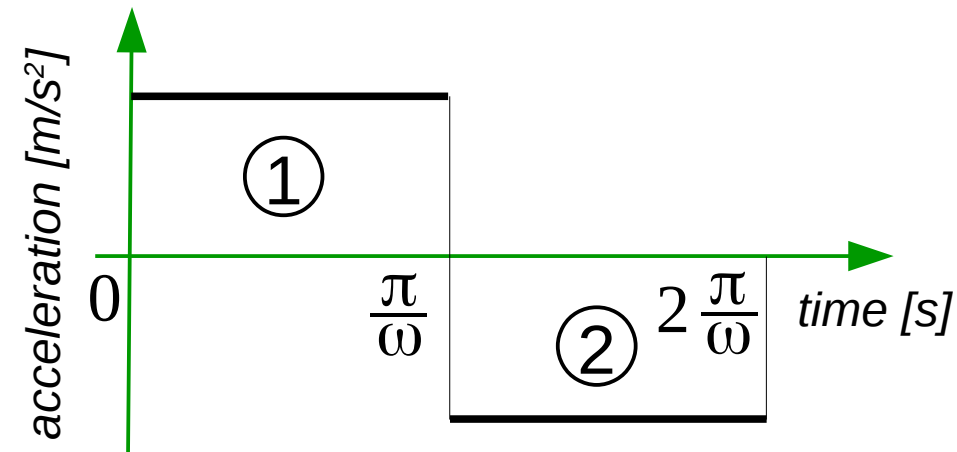

$$a_1 = a_0$$

$$v_1(t) = a_0 t + C_1$$

$$h_1(t) = \frac{a_0 t^2}{2} + C_1 t + C_2$$

$$a_2 = -a_0$$

$$v_2(t) = -a_0 t + C_3$$

$$h_2(t) = \frac{-a_0 t^2}{2} + C_3 t + C_4$$

Synthesis of cam-follower mechanisms

Analytical method – example

Design profile of a cam cooperating with eccentric knife-edge follower to obtain constant acceleration of uplift and downlift with constant angular velocity.

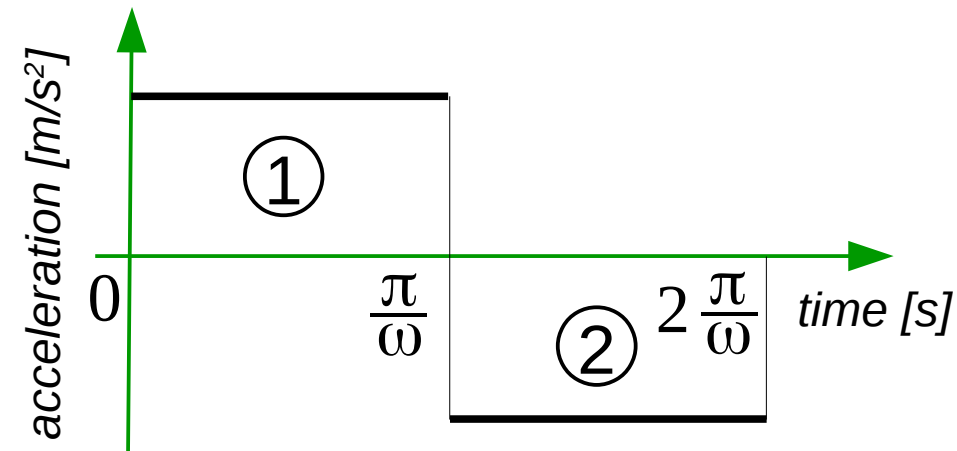

Cam base-radius

$$h_1(t=0) = h_2(t=2\frac{\pi}{\omega}) = R$$

$$C_2 = R$$

$$C_4 = R + 2a_0\frac{\pi^2}{\omega^2} - 2C_3\frac{\pi}{\omega}$$

$$a_1 = a_0$$

$$a_2 = -a_0$$

$$v_1(t) = a_0 t + C_1$$

$$v_2(t) = -a_0 t + C_3$$

$$h_1(t) = \frac{a_0 t^2}{2} + C_1 t + C_2 \quad h_2(t) = \frac{-a_0 t^2}{2} + C_3 t + C_4$$

Synthesis of cam-follower mechanisms

Analytical method – example

Design profile of a cam cooperating with eccentric knife-edge follower to obtain constant acceleration of uplift and downlift with constant angular velocity.

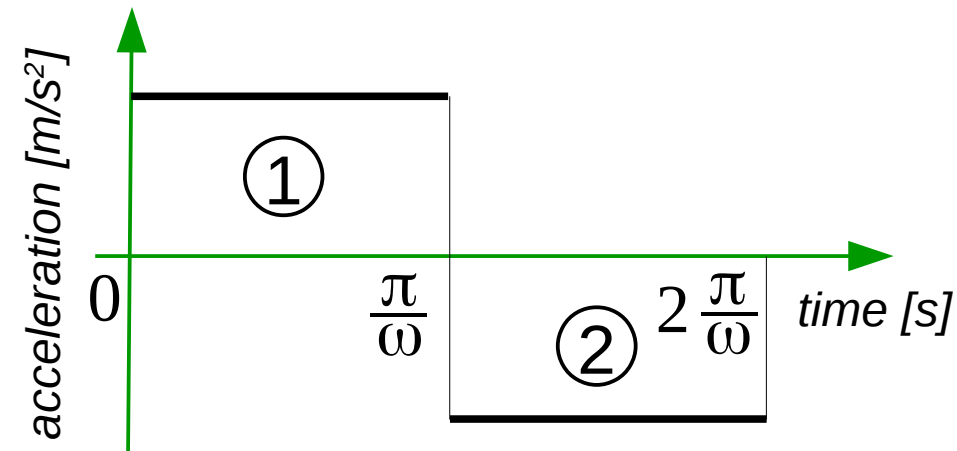

Cam base-radius

$$h_1(t=0) = h_2(t=2\frac{\pi}{\omega}) = R$$

$$C_2 = R$$

$$C_4 = R + 2a\frac{\pi^2}{\omega^2} - 2C_3\frac{\pi}{\omega}$$

$$a_1 = a_0$$

$$a_2 = -a_0$$

$$v_1(t) = a_0 t + C_1$$

$$v_2(t) = -a_0 t + C_3$$

$$h_1(t) = \frac{a_0 t^2}{2} + C_1 t + R \quad h_2(t) = \frac{-a_0 t^2}{2} + C_3 t + R + 2a_0 \frac{\pi^2}{\omega^2} - 2C_3 \frac{\pi}{\omega}$$

Synthesis of cam-follower mechanisms

Analytical method – example

Design profile of a cam cooperating with eccentric knife-edge follower to obtain constant acceleration of uplift and downlift with constant angular velocity.

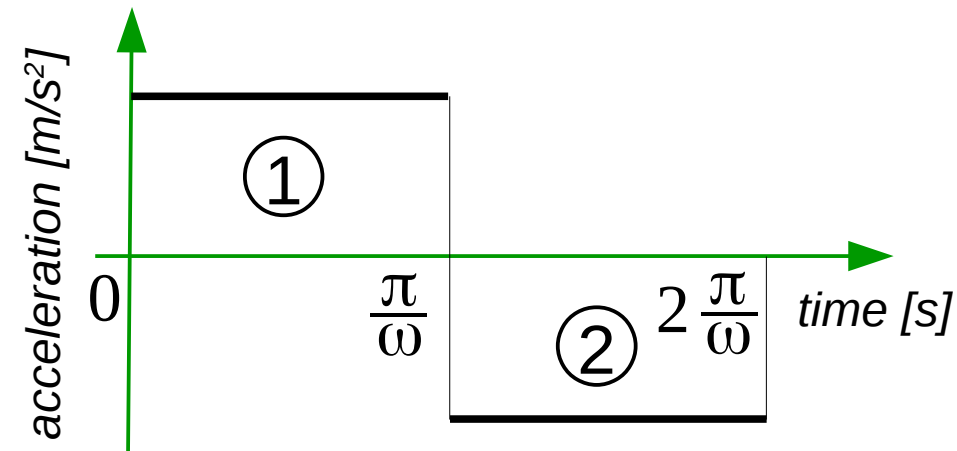

Cam outline continuity

$$h_2\left(t = \frac{\pi}{\omega}\right) = h_1\left(t = \frac{\pi}{\omega}\right)$$

$$a_1 = a_0$$

$$v_1(t) = a_0 t + C_1$$

$$h_1(t) = \frac{a_0 t^2}{2} + C_1 t + R$$

$$a_2 = -a_0$$

$$v_2(t) = -a_0 t + C_3$$

$$h_2(t) = \frac{-a_0 t^2}{2} + C_3 t + R + 2a_0 \frac{\pi^2}{\omega^2} - 2C_3 \frac{\pi}{\omega}$$

Synthesis of cam-follower mechanisms

Analytical method – example

Design profile of a cam cooperating with eccentric knife-edge follower to obtain constant acceleration of uplift and downlift with constant angular velocity.

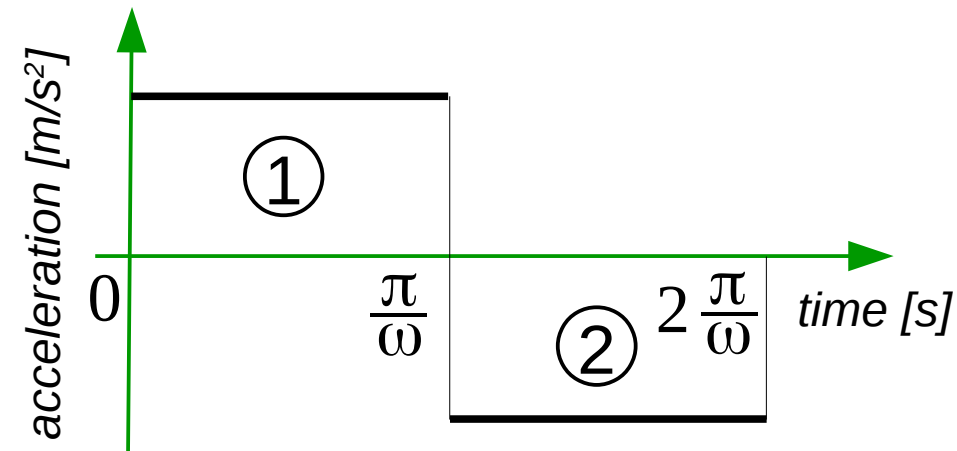

Cam outline continuity

$$h_2\left(t = \frac{\pi}{\omega}\right) = h_1\left(t = \frac{\pi}{\omega}\right)$$

$$C_3 = a_0 \frac{\pi}{\omega} - C_1$$

$$a_1 = a_0$$

$$v_1(t) = a_0 t + C_1$$

$$h_1(t) = \frac{a_0 t^2}{2} + C_1 t + R$$

$$a_2 = -a_0$$

$$v_2(t) = -a_0 t + C_3$$

$$h_2(t) = \frac{-a_0 t^2}{2} + C_3 t + R + 2 a_0 \frac{\pi^2}{\omega^2} - 2 C_3 \frac{\pi}{\omega}$$

Synthesis of cam-follower mechanisms

Analytical method – example

Design profile of a cam cooperating with eccentric knife-edge follower to obtain constant acceleration of uplift and downlift with constant angular velocity.

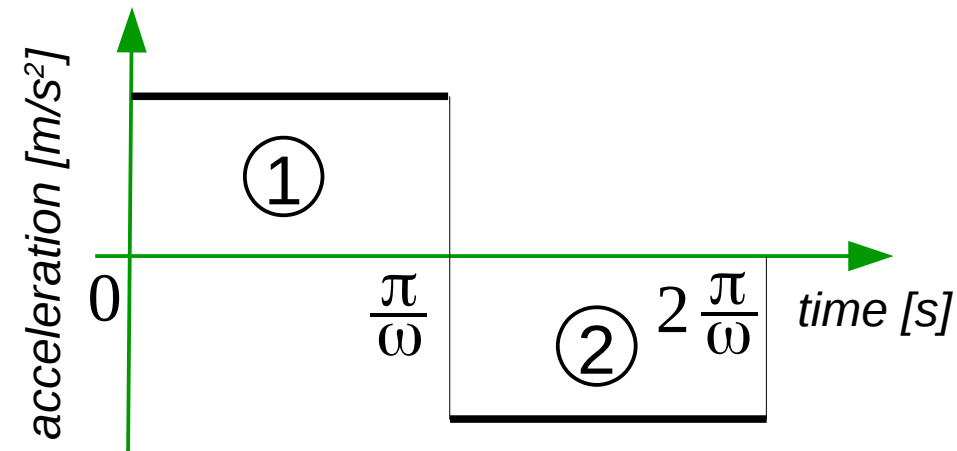

Cam outline continuity

$$h_2\left(t = \frac{\pi}{\omega}\right) = h_1\left(t = \frac{\pi}{\omega}\right)$$

$$C_3 = a_0 \frac{\pi}{\omega} - C_1$$

$$a_1 = a_0$$

$$v_1(t) = a_0 t + C_1$$

$$h_1(t) = \frac{a_0 t^2}{2} + C_1 t + R$$

$$a_2 = -a_0$$

$$v_2(t) = -a_0 t + a_0 \frac{\pi}{\omega} - C_1$$

$$h_2(t) = \frac{-a_0 t^2}{2} + R + a_0 \frac{\pi}{\omega} t + C_1 \left(2\frac{\pi}{\omega} - t\right)$$

Synthesis of cam-follower mechanisms

Analytical method – example

Design profile of a cam cooperating with eccentric knife-edge follower to obtain constant acceleration of uplift and downlift with constant angular velocity.

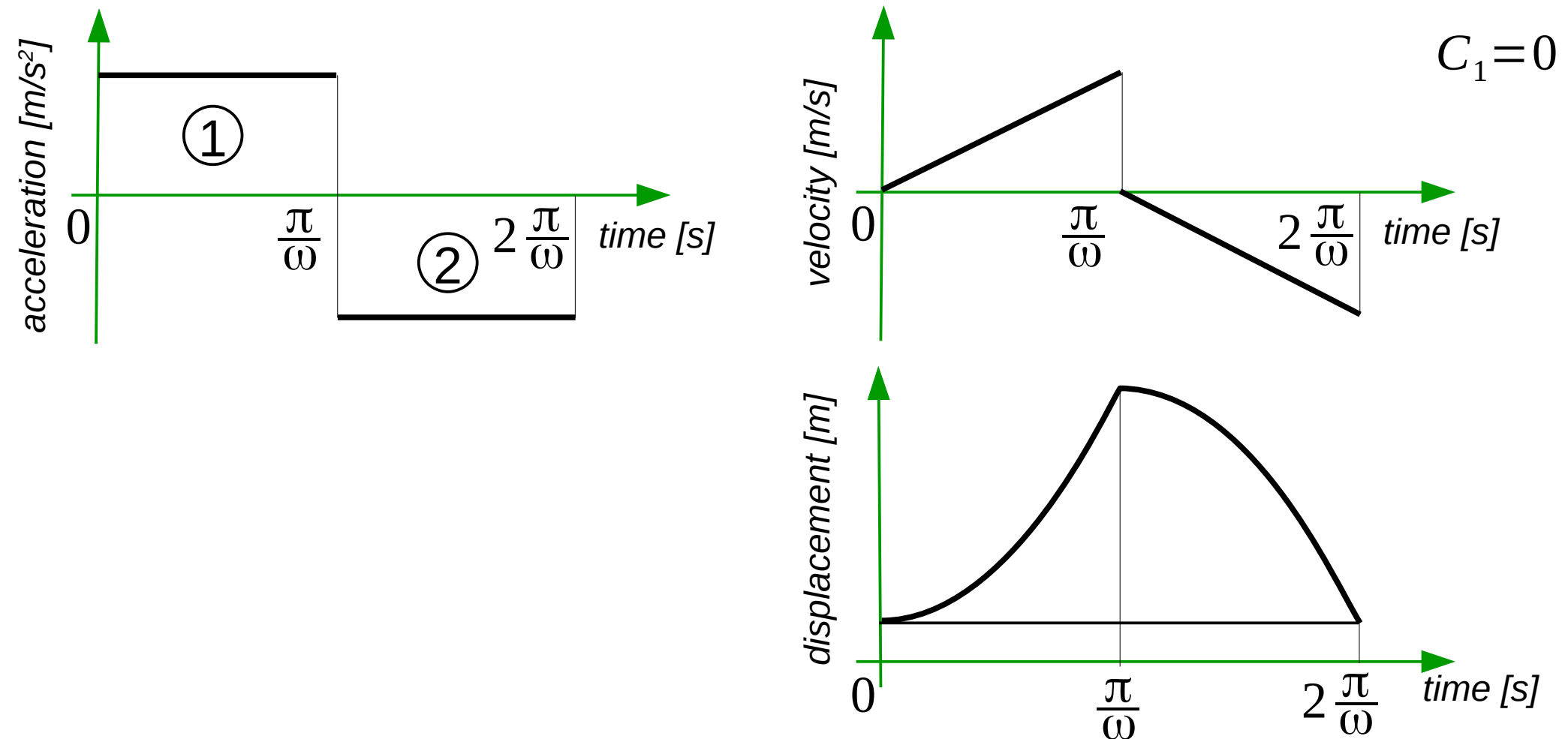

Synthesis of cam-follower mechanisms

Analytical method – example

Design profile of a cam cooperating with eccentric knife-edge follower to obtain constant acceleration of uplift and downlift with constant angular velocity.

$$h(t) = \begin{cases} \frac{a_0 t^2}{2} + C_1 t + R, & \text{for } t \in (0, \frac{\pi}{\omega}) \\ \frac{-a_0 t^2}{2} + R + a_0 \frac{\pi}{\omega} t + C_1 (2 \frac{\pi}{\omega} - t), & \text{for } t \in (\frac{\pi}{\omega}, 2 \frac{\pi}{\omega}) \end{cases}$$

Synthesis of cam-follower mechanisms

Analytical method – example

Design profile of a cam cooperating with eccentric knife-edge follower to obtain constant acceleration of uplift and downlift with constant angular velocity.

$$h(t) = \begin{cases} \frac{a_0 t^2}{2} + C_1 t + R, & \text{for } t \in (0, \frac{\pi}{\omega}) \\ -\frac{a_0 t^2}{2} + R + a_0 \frac{\pi}{\omega} t + C_1 (2 \frac{\pi}{\omega} - t), & \text{for } t \in (\frac{\pi}{\omega}, 2 \frac{\pi}{\omega}) \end{cases}$$

With follower offset consideration

$$\rho(t) = \sqrt{h^2(t) + m^2}$$

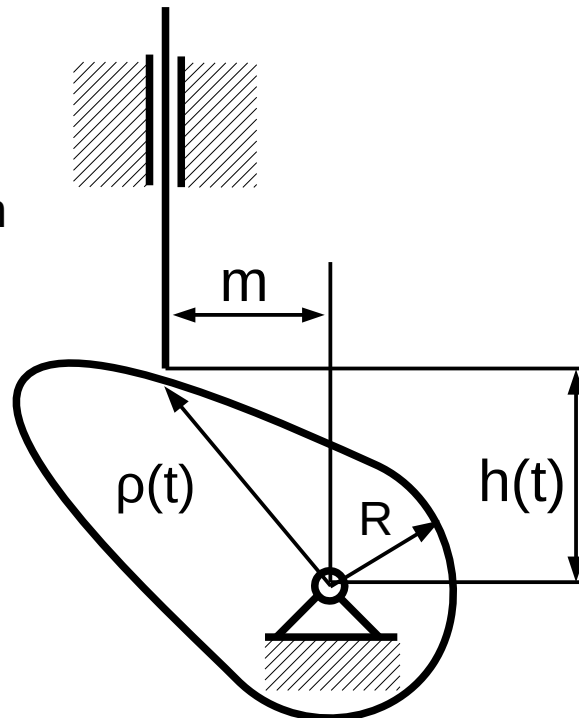

Synthesis of cam-follower mechanisms

Analytical method – example

Design profile of a cam cooperating with eccentric knife-edge follower to obtain constant acceleration of uplift and downlift with constant angular velocity.

$$h(t) = \begin{cases} \frac{a_0 t^2}{2} + C_1 t + R, & \text{for } t \in (0, \frac{\pi}{\omega}) \\ \frac{-a_0 t^2}{2} + R + a_0 \frac{\pi}{\omega} t + C_1 (2 \frac{\pi}{\omega} - t), & \text{for } t \in (\frac{\pi}{\omega}, 2 \frac{\pi}{\omega}) \end{cases}$$

With follower offset consideration

$$\rho(t) = \sqrt{h^2(t) + m^2}$$

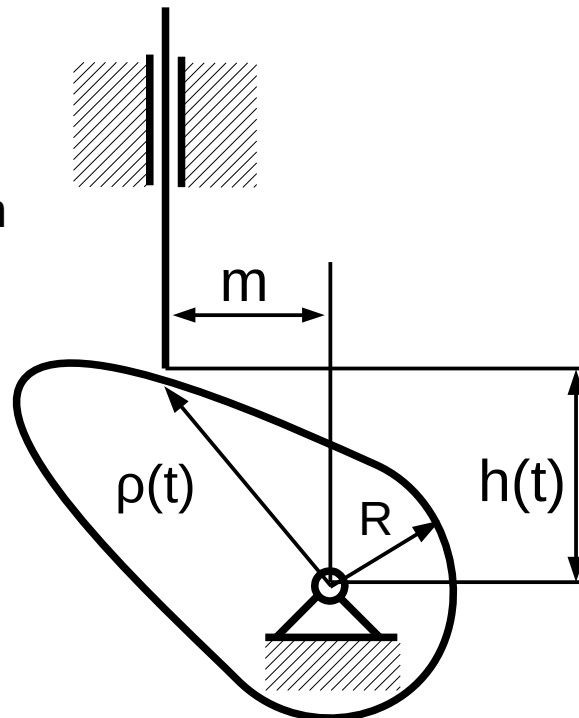

From polar to Cartesian coordinate

$$\begin{aligned} x(t) &= \rho(t) \cos \omega t \\ y(t) &= \rho(t) \sin \omega t \end{aligned}$$

Synthesis of cam-follower mechanisms

Analytical method – example

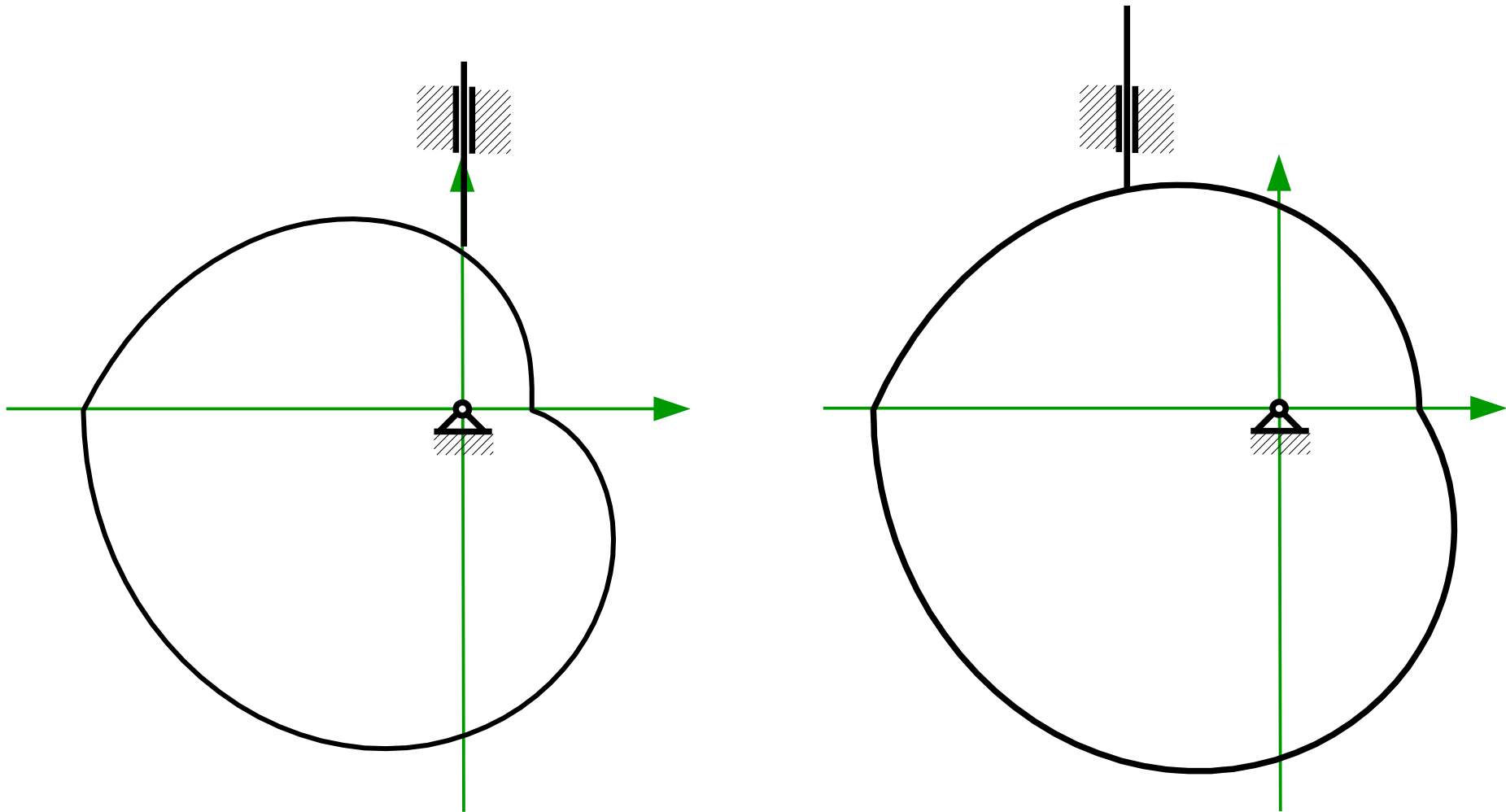

Synthesis of cam-follower mechanisms

Analytical method – example

Design profile of a cam cooperating with eccentric knife-edge follower to obtain constant acceleration of uplift and downlift with constant angular velocity.

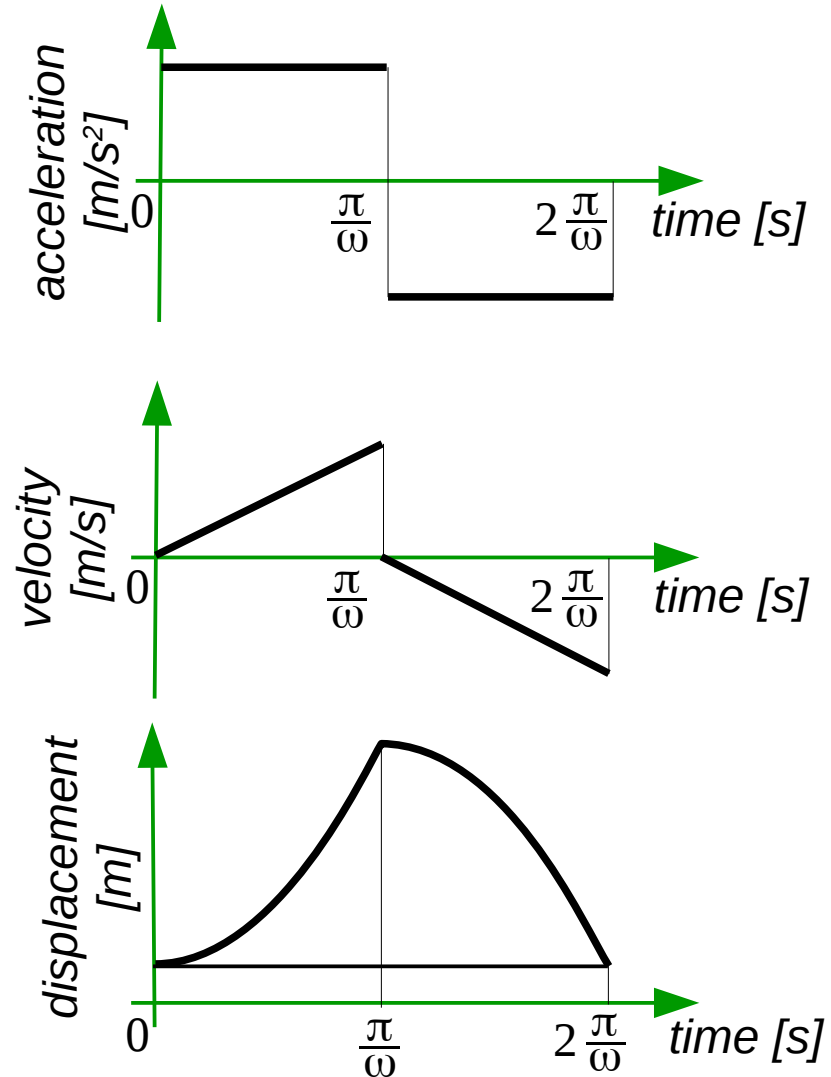
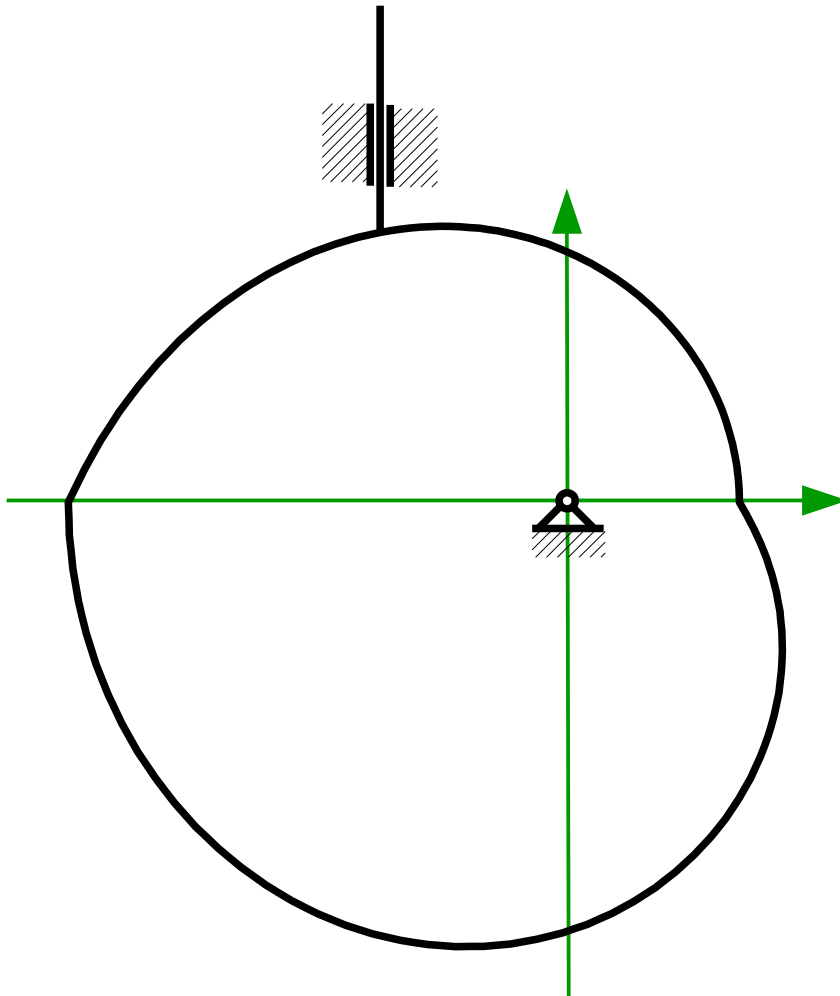

Synthesis of cam-follower mechanisms

Analytical method – example 2

Design profile of a cam cooperating with centric knife-edge follower to obtain harmonic acceleration with constant angular velocity.

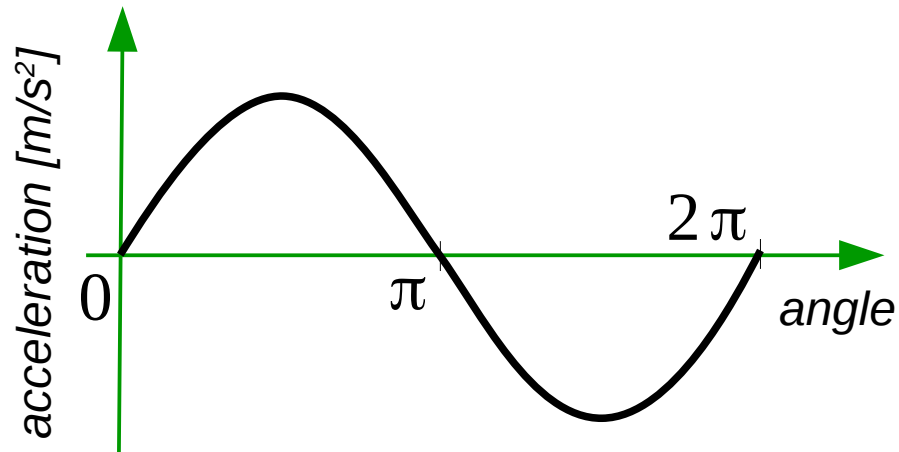

Cam-follower mechanisms

Distance of contact and angle of contact

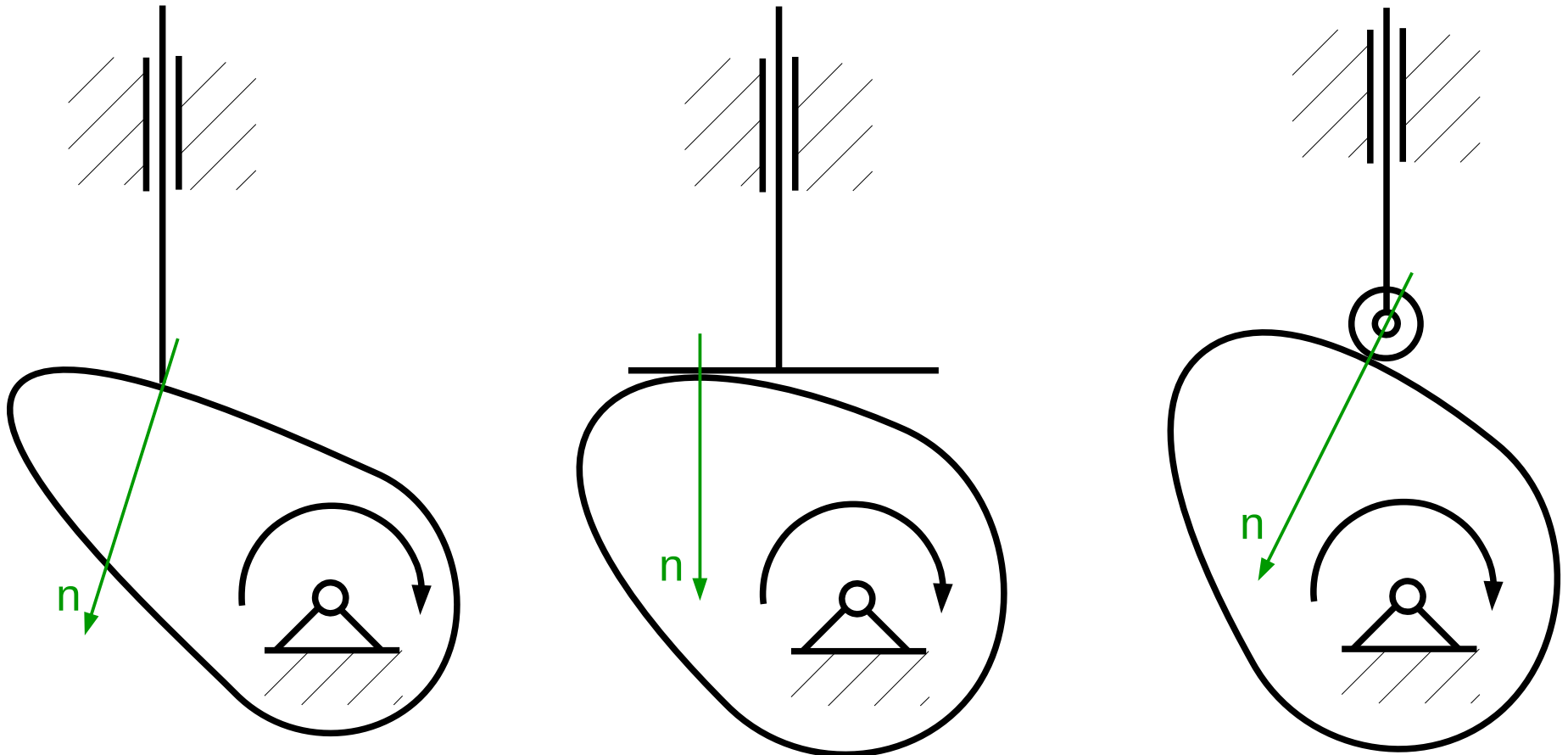

Cam-follower mechanisms

Distance of contact and angle of contact

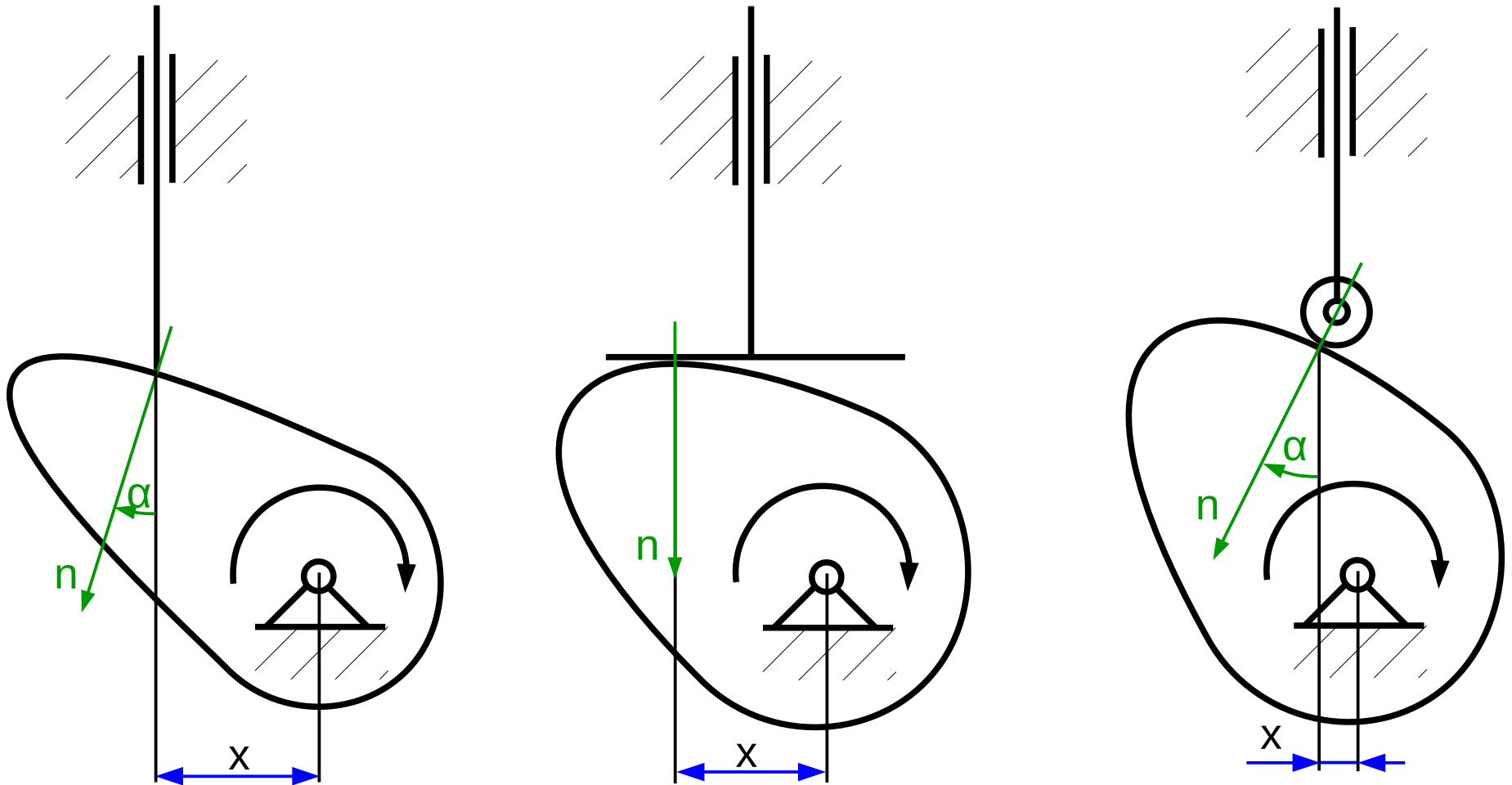

Cam-follower mechanisms

Distance of contact and angle of contact

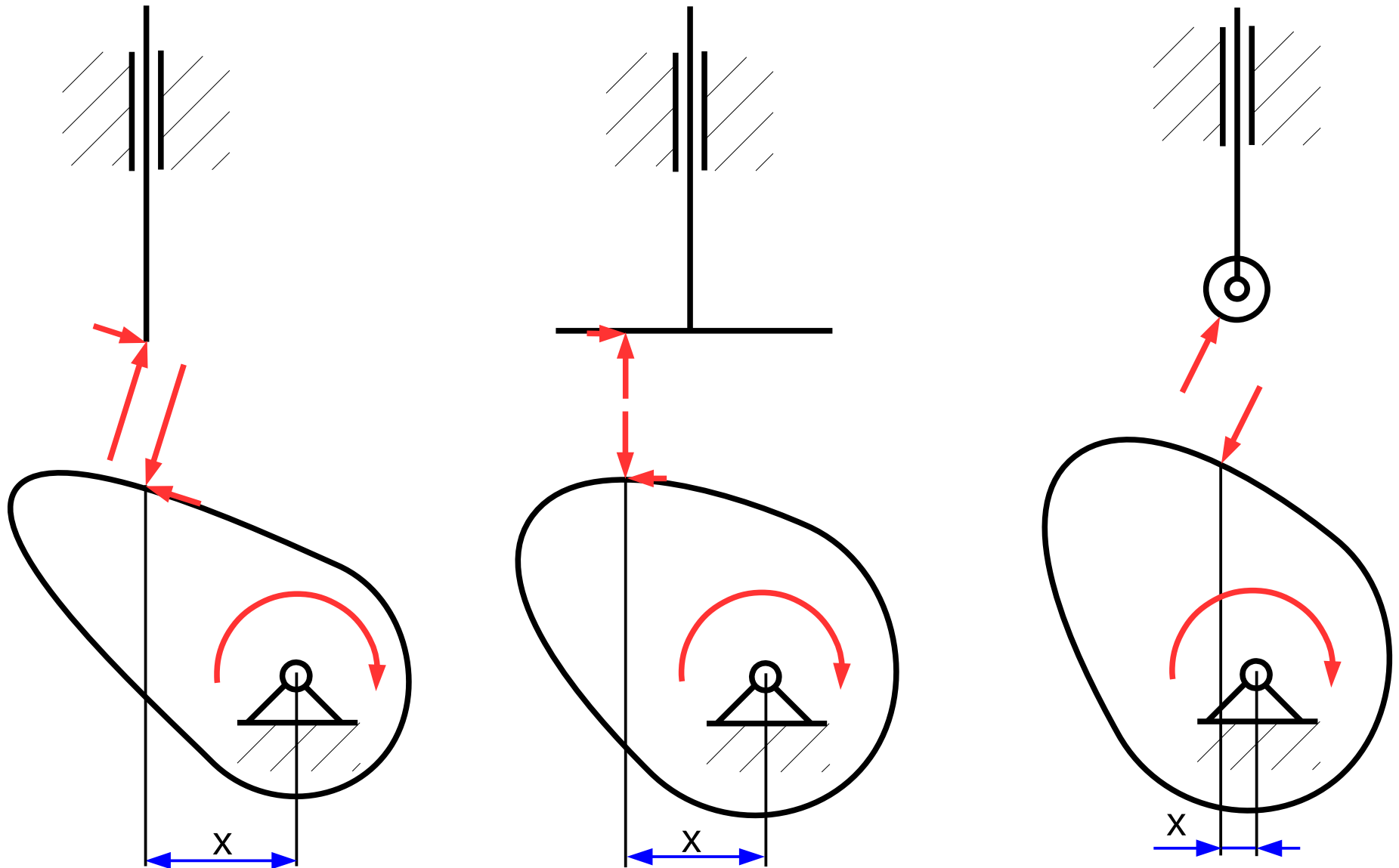

Cam-follower mechanisms

Minimal cam size

1st condition: minimum cam radius in case of material strength and wear resistance.

Cam-follower mechanisms

Minimal cam size

2nd condition: maximum angle of contact in case of follower bending resistance and pressure inside the socket.

Cam-follower mechanisms

Minimal cam size

3rd condition: maximum distance of contact in case of follower's stem bending (for a flat-faced followers).

Cam-follower mechanisms

Minimal cam size

Follower offset towards direction opposite to direction of rotation decreases maximum angle of contact

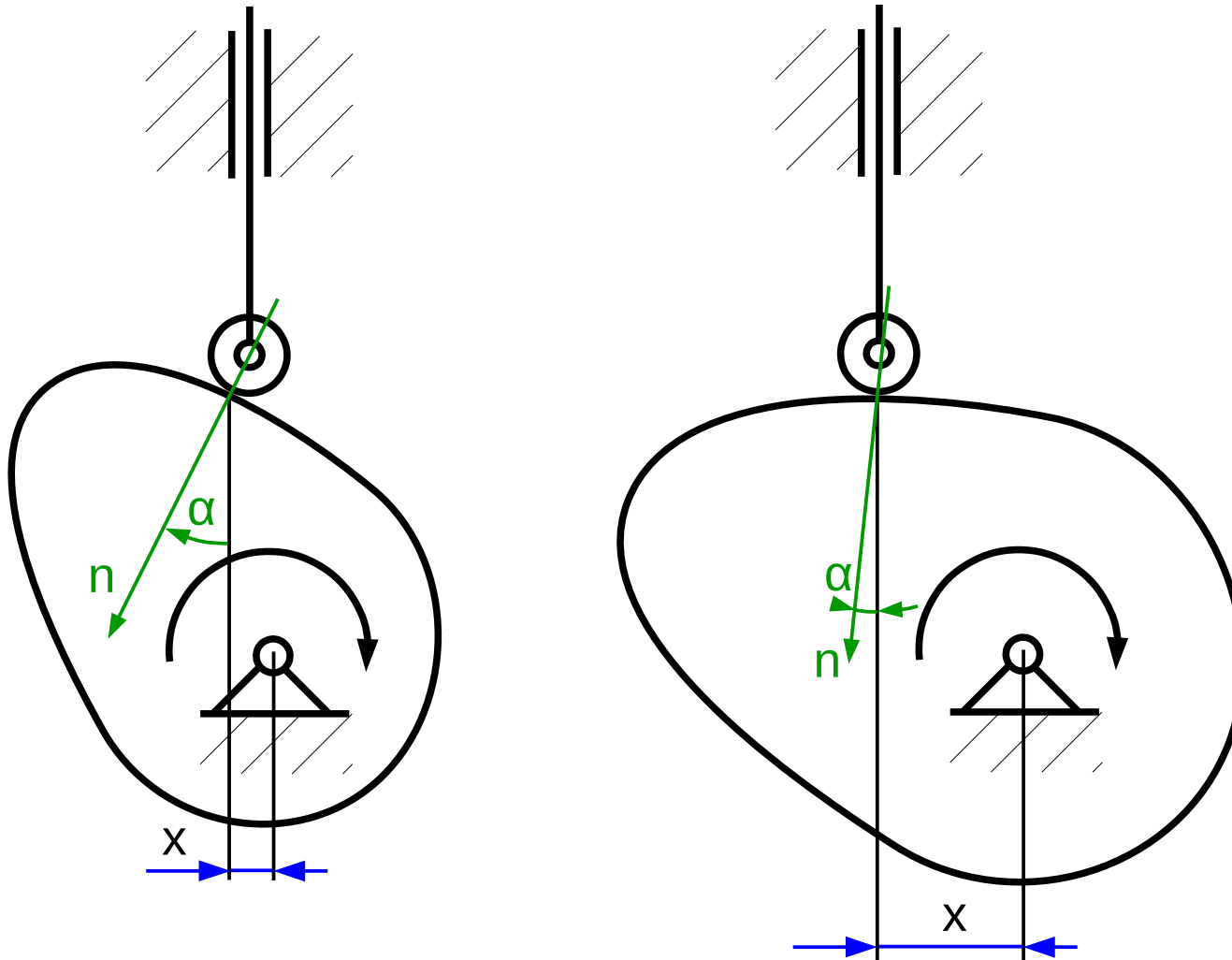

Dynamics of planar mechanisms

Dynamics of planar mechanisms

Overview

Members description as rigid bodies and and material points.

Graphical determination of inertial forces and torques.

Reaction forces in kinematic pairs.

Driving and operating forces/torques.

Inverse and direct dynamics problems.

Graphical, analytical and graphical-analytical method.

Friction in kinematic pairs.

Dynamics of planar mechanisms

Members description

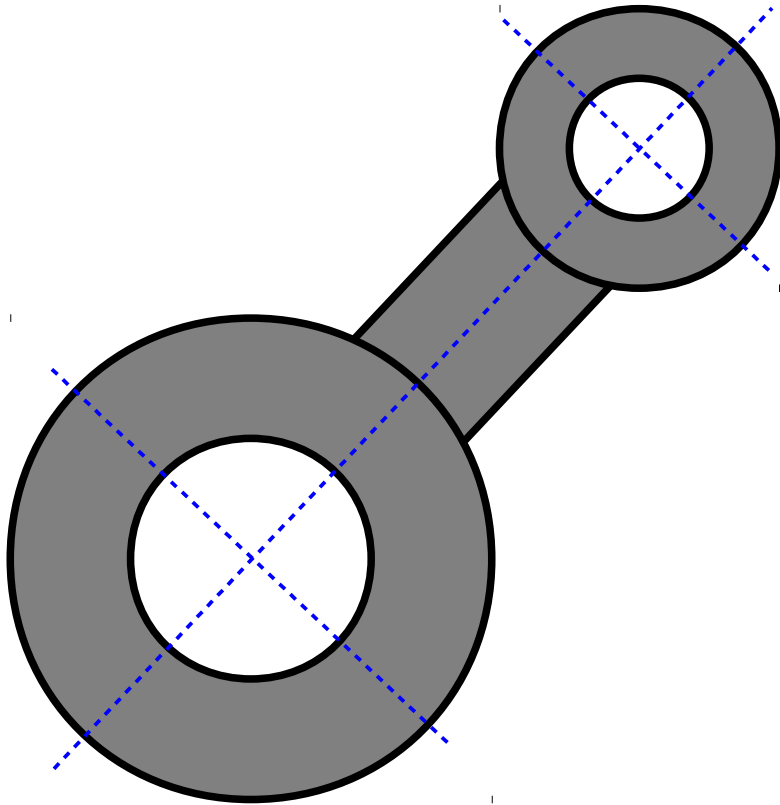

For a planar mechanism member represented by a rigid body:

Dynamics of planar mechanisms

Members description

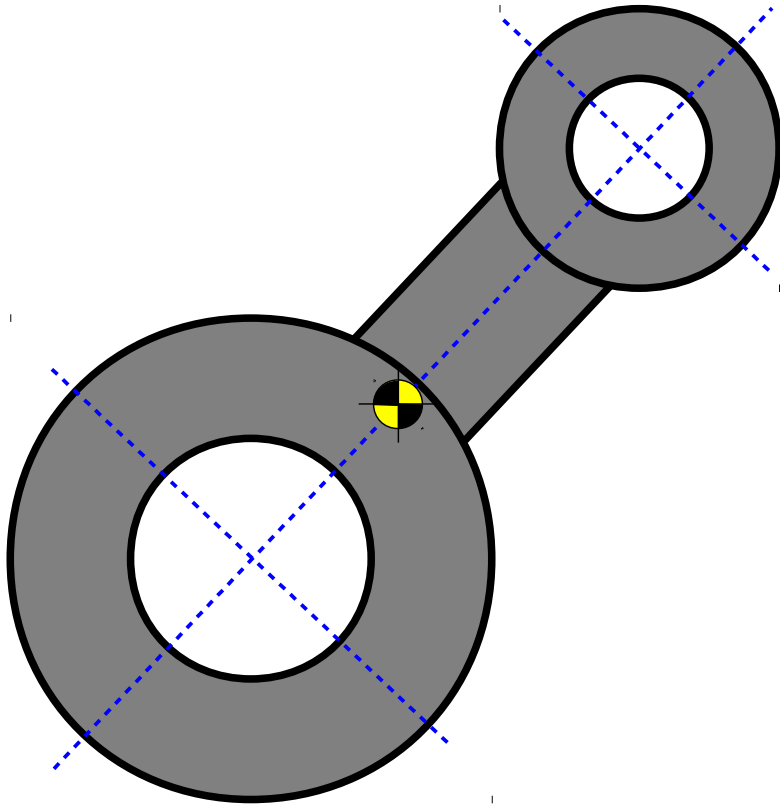

For a planar mechanism member represented by a rigid body:

- mass
- location of a center of a mass
- mass moment of inertia wrt the axis perpendicular to the motion plane in center of a mass
- location of connection points

Dynamics of planar mechanisms

Members description

Material points method

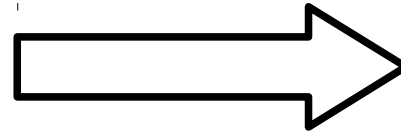
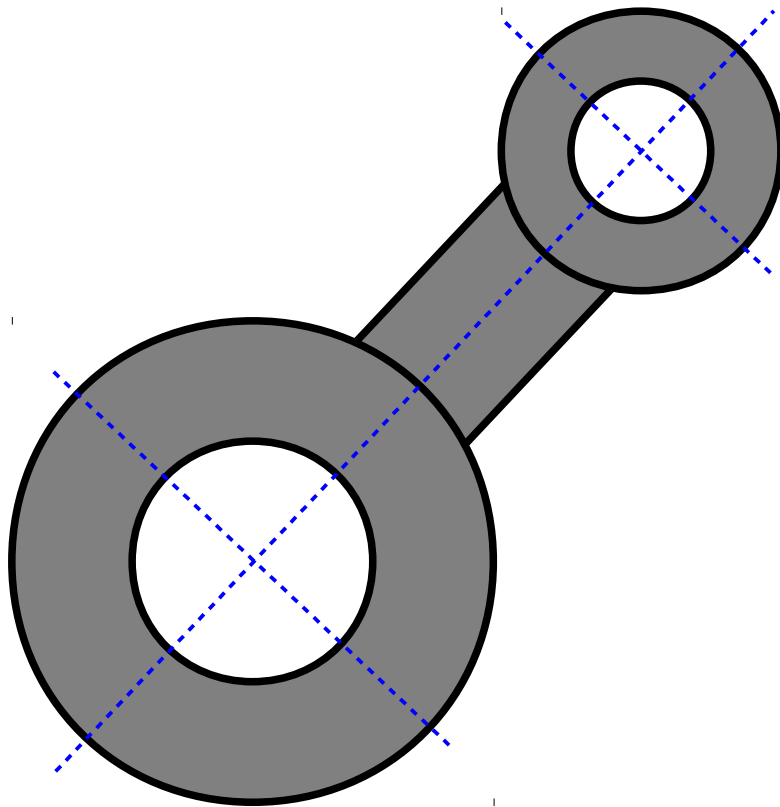

a set of material points

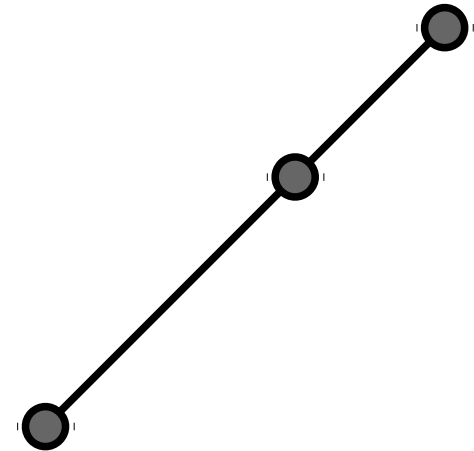

Dynamics of planar mechanisms

Members description

Material points method

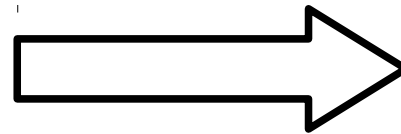
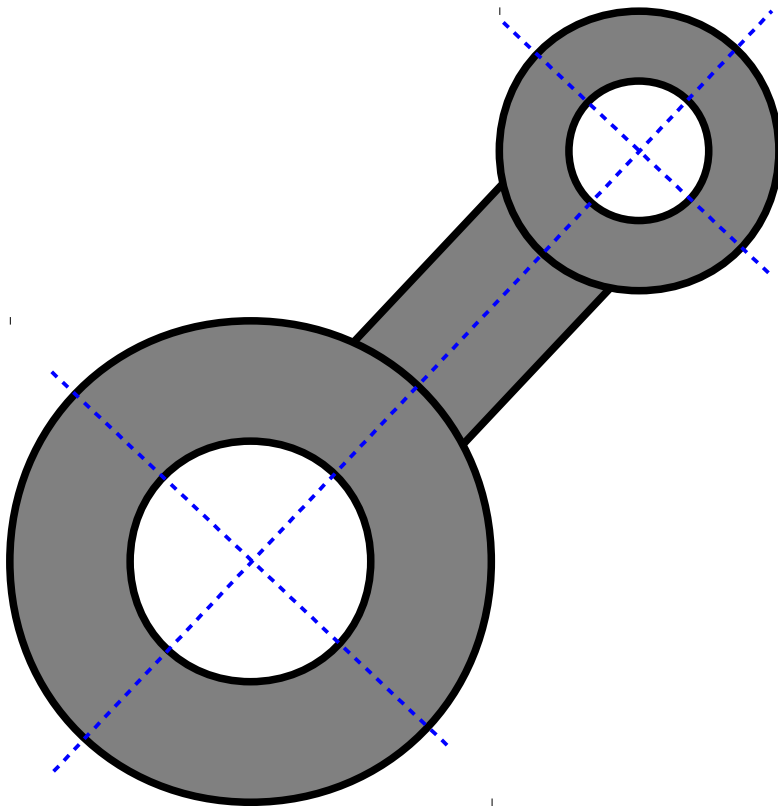

a set of material points

- same masses
- same center of mass
- same inertia

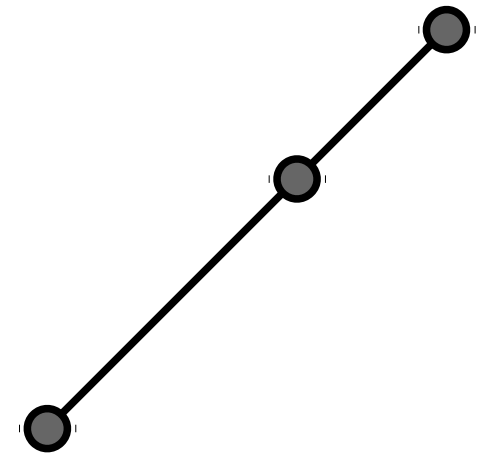

Dynamics of planar mechanisms

Members description

Material points method - example

Given:

Geometry, mass m ,
center of a mass location
(pt. C) and mass moment
of inertia I_C

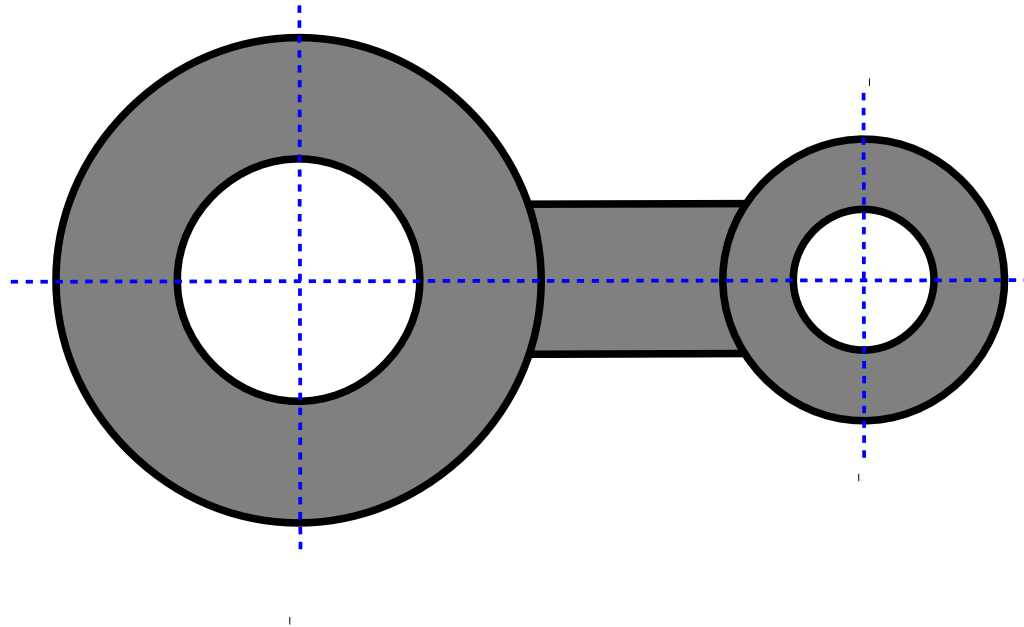

Dynamics of planar mechanisms

Members description

Material points method - example

Given:

Geometry, mass m ,
center of a mass location
(pt. C) and mass moment
of inertia I_C

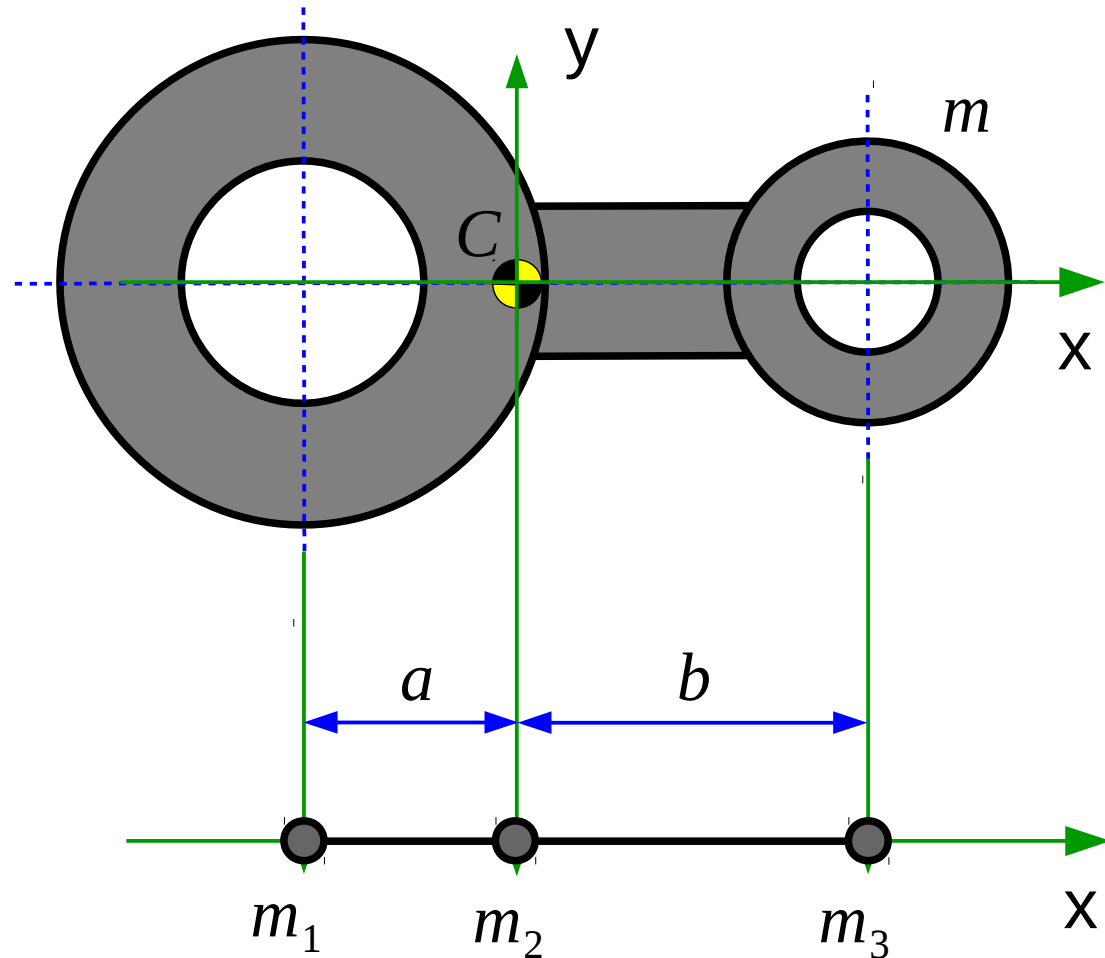

Dynamics of planar mechanisms

Members description

Material points method - example

Given:

Geometry, mass m ,
center of a mass location
(pt. C) and mass moment
of inertia I_C

$$m_1 + m_2 + m_3 = m$$

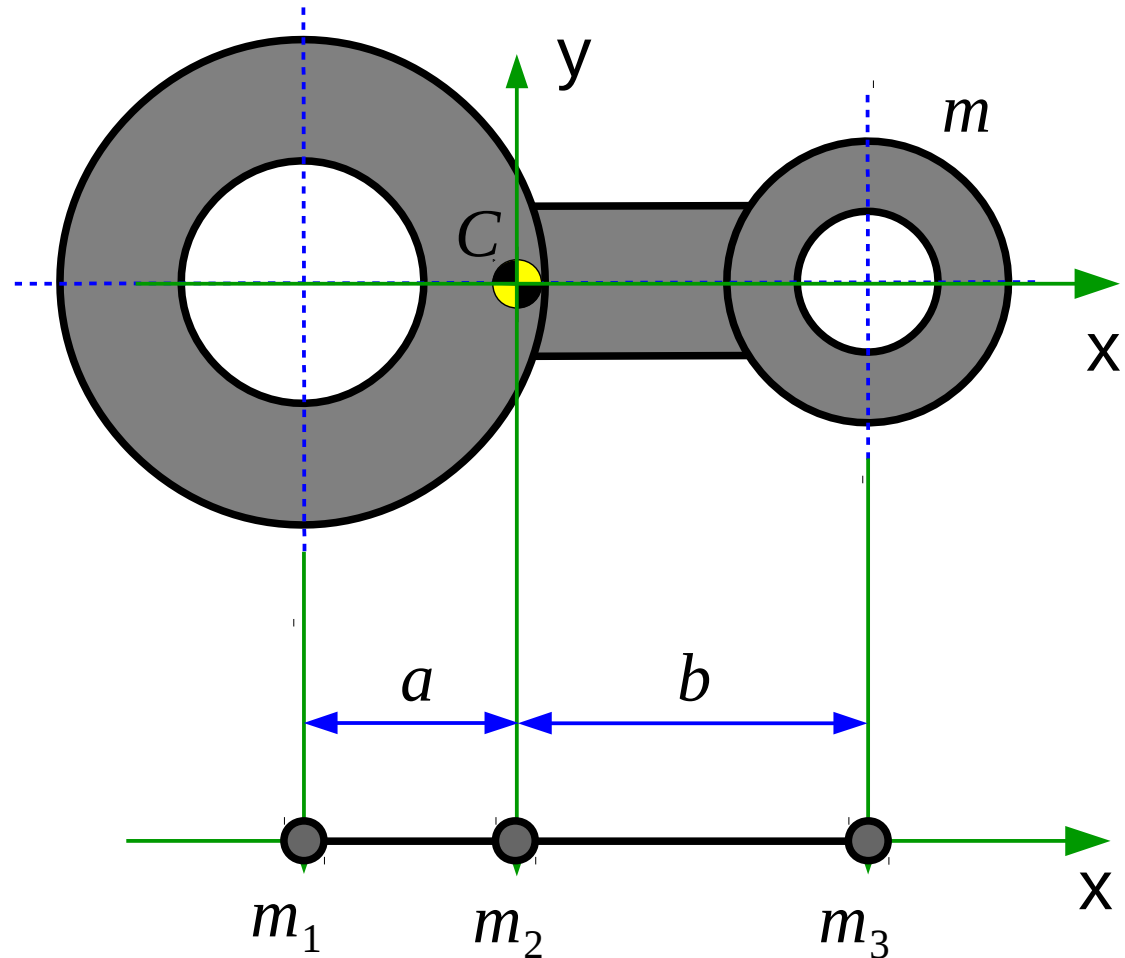

Dynamics of planar mechanisms

Members description

Material points method - example

Given:

Geometry, mass m ,
center of a mass location
(pt. C) and mass moment
of inertia I_C

$$m_1 + m_2 + m_3 = m$$

$$\frac{-a m_1 + b m_3}{m_1 + m_2 + m_3} = 0$$

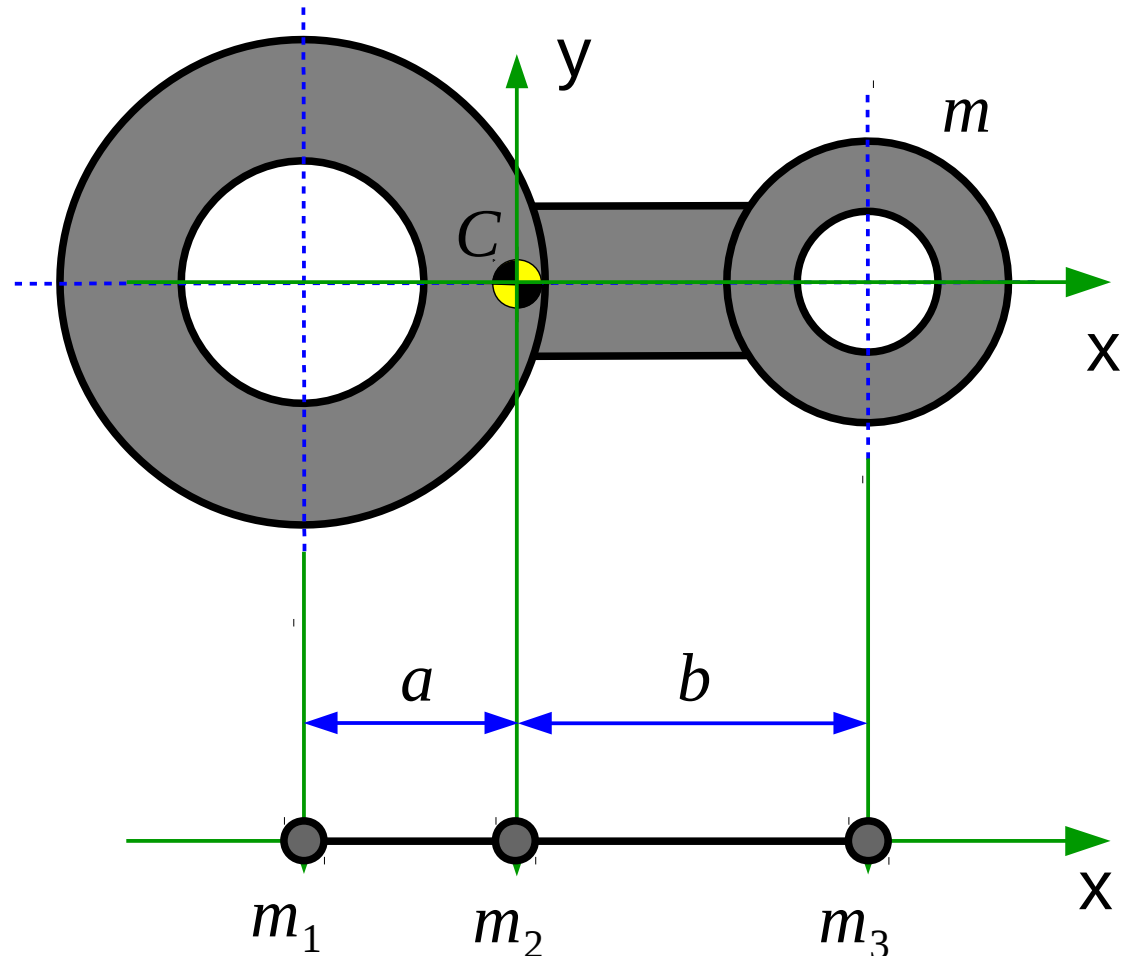

Dynamics of planar mechanisms

Members description

Material points method - example

Given:

Geometry, mass m ,
center of a mass location
(pt. C) and mass moment
of inertia I_C

$$m_1 + m_2 + m_3 = m$$

$$\frac{-a m_1 + b m_3}{m_1 + m_2 + m_3} = 0$$

$$m_1 a^2 + m_3 b^2 = I_C$$

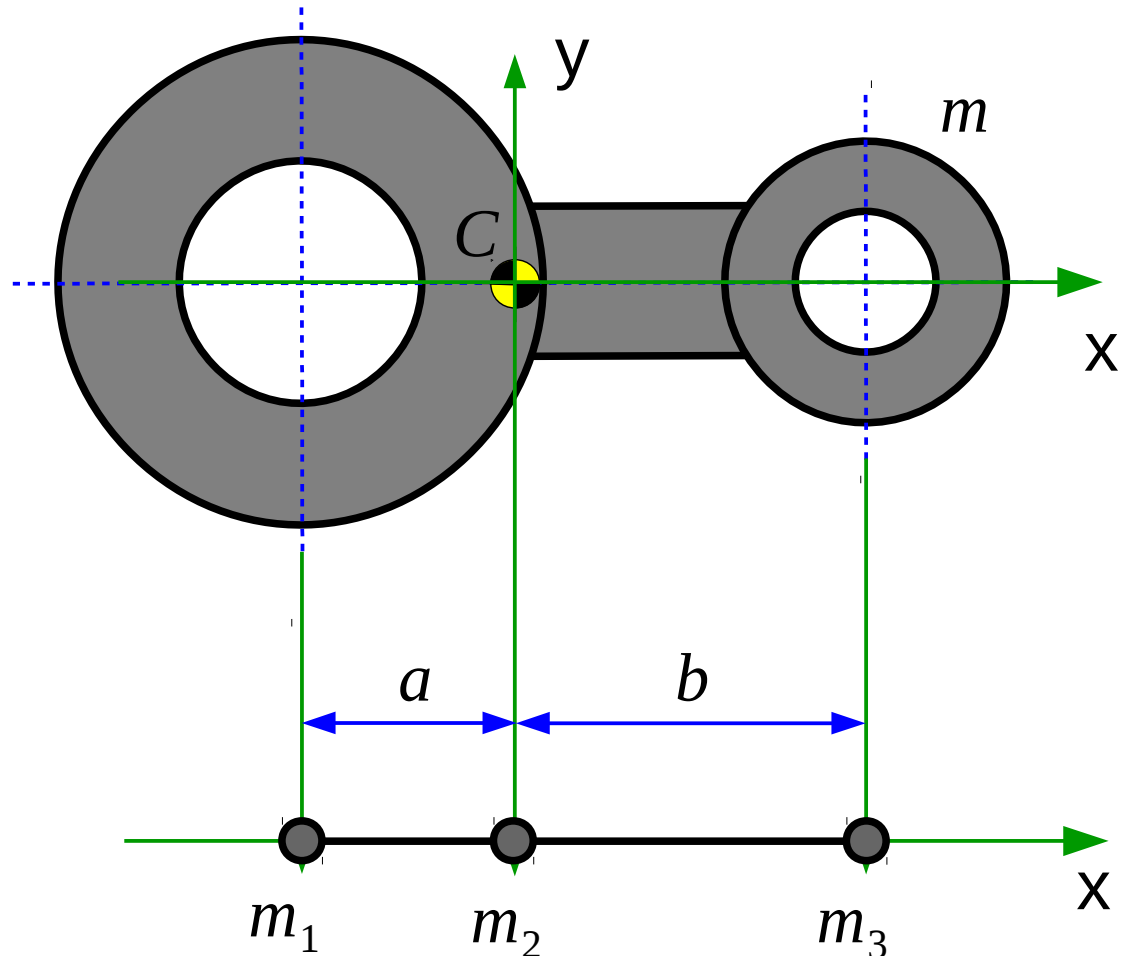

Dynamics of planar mechanisms

Inertia forces and torques

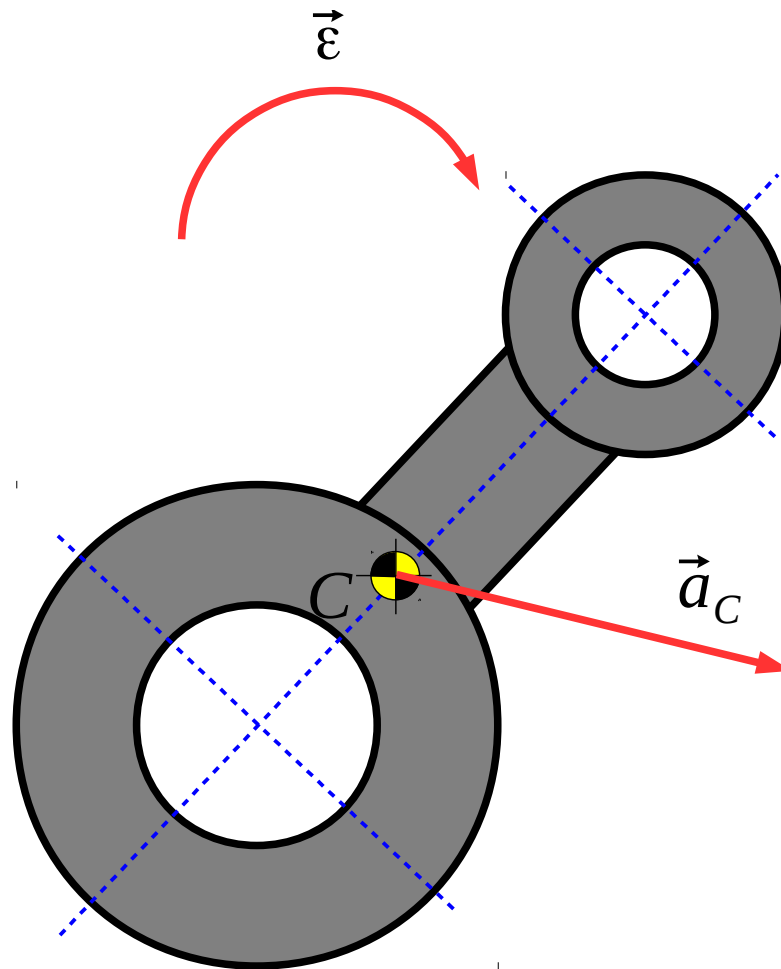

Dynamics of planar mechanisms

Inertia forces and torques

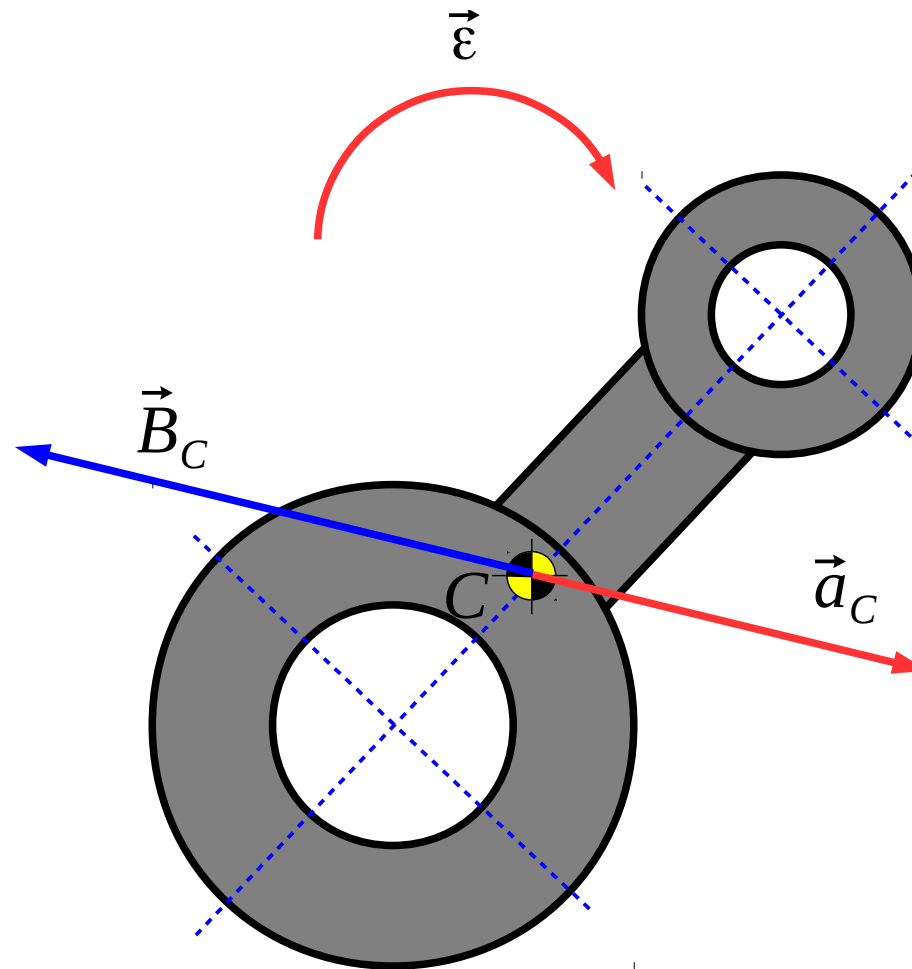

inertia force

$$\vec{B}_C = -m \vec{a}_C$$

Dynamics of planar mechanisms

Inertia forces and torques

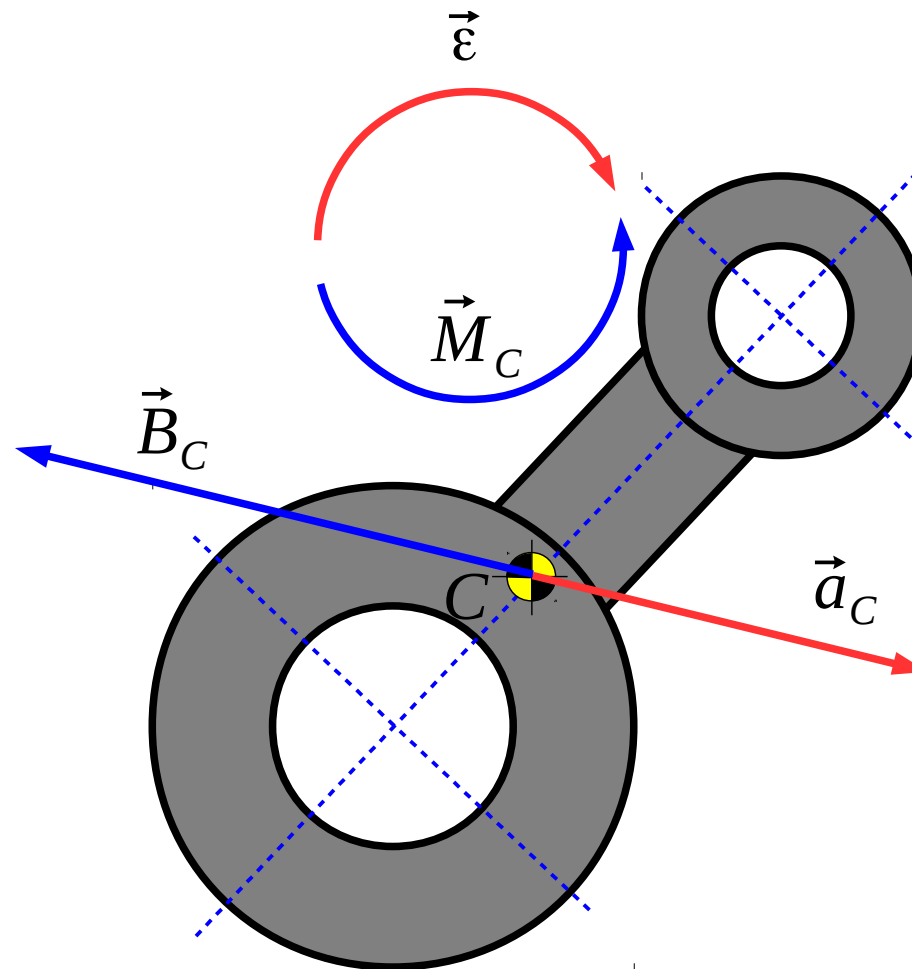

inertia force

$$\vec{B}_C = -m \vec{a}_C$$

Inertia torque

$$\vec{M}_C = -I_C \vec{\varepsilon}$$

Dynamics of planar mechanisms

Reaction forces inside a kinematic pairs (without friction)

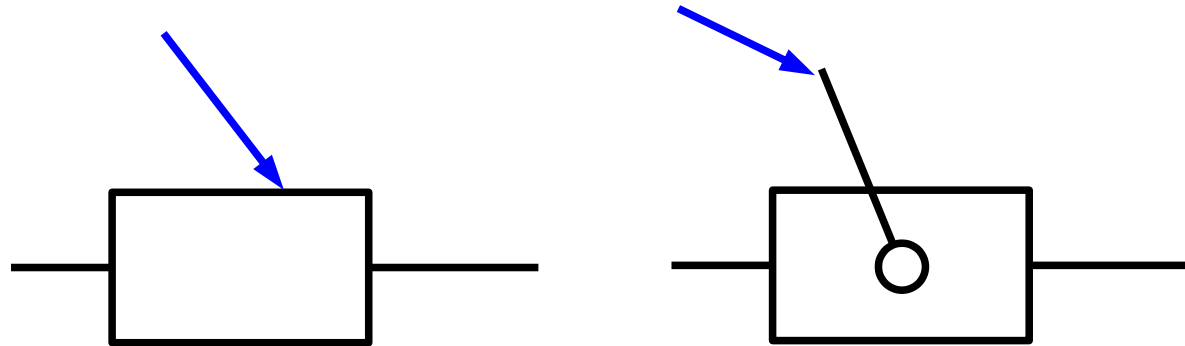

Dynamics of planar mechanisms

Reaction forces inside a kinematic pairs (without friction)

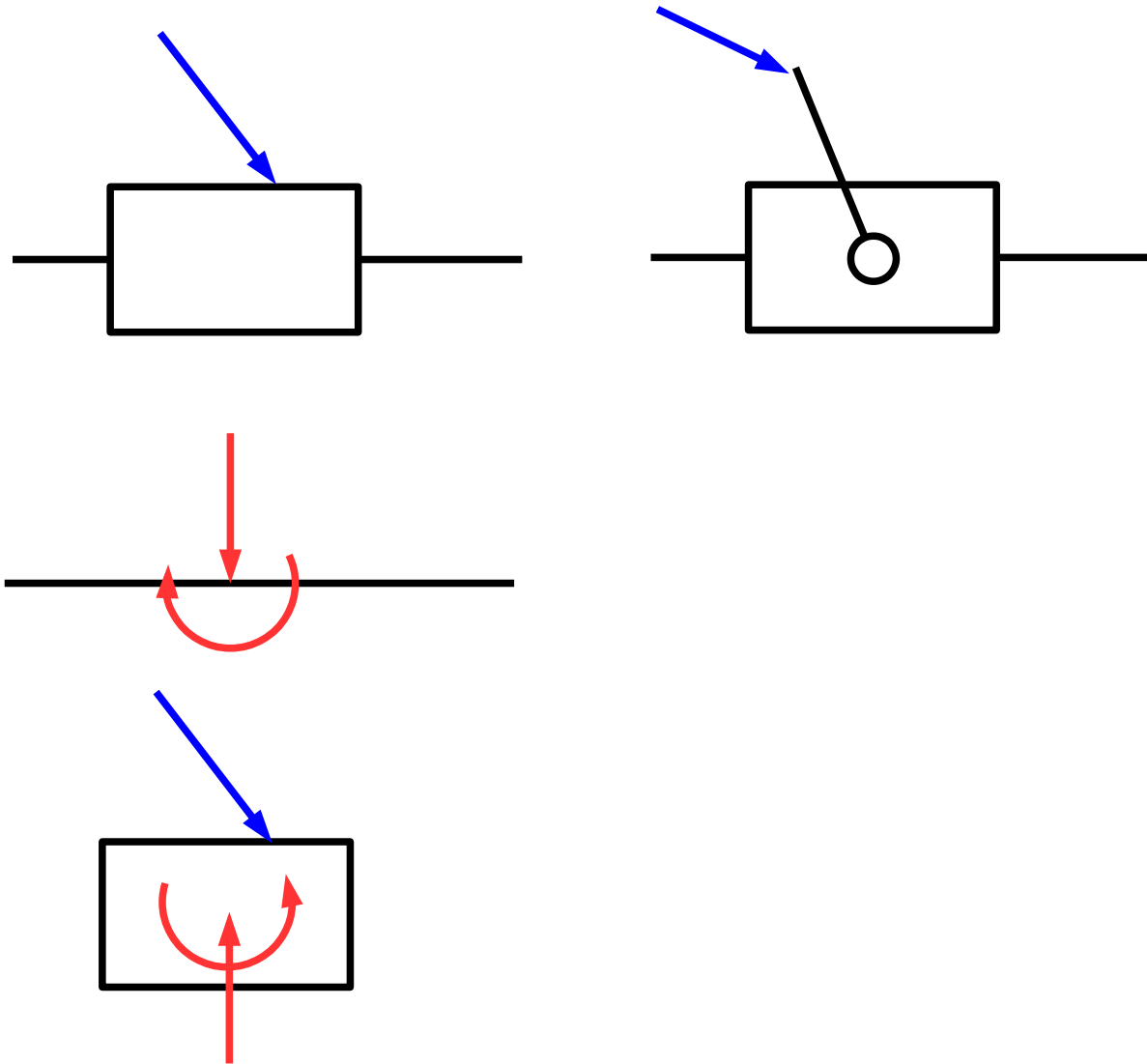

Dynamics of planar mechanisms

Reaction forces inside a kinematic pairs (without friction)

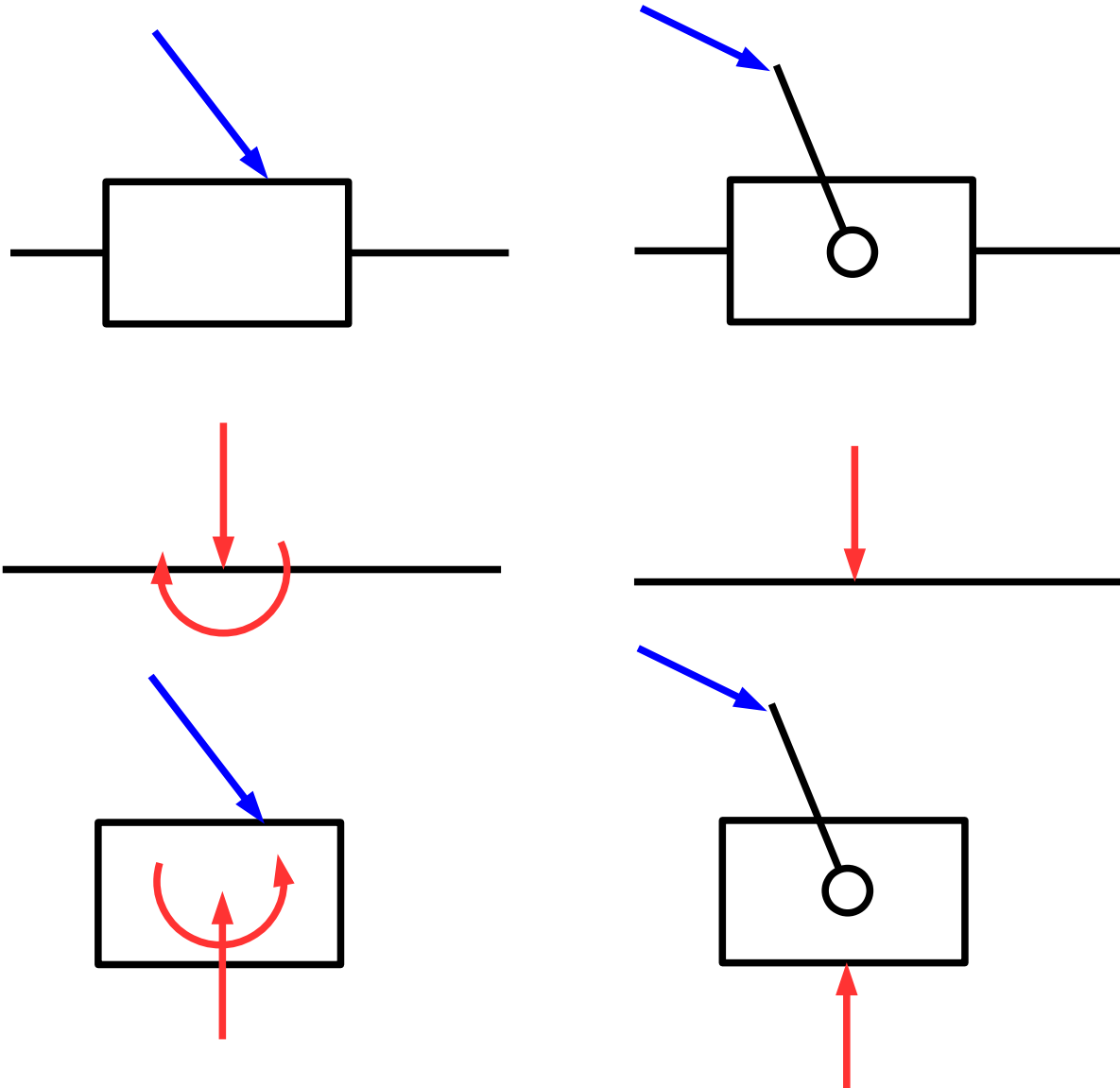

Dynamics of planar mechanisms

Reaction forces inside a kinematic pairs (without friction)

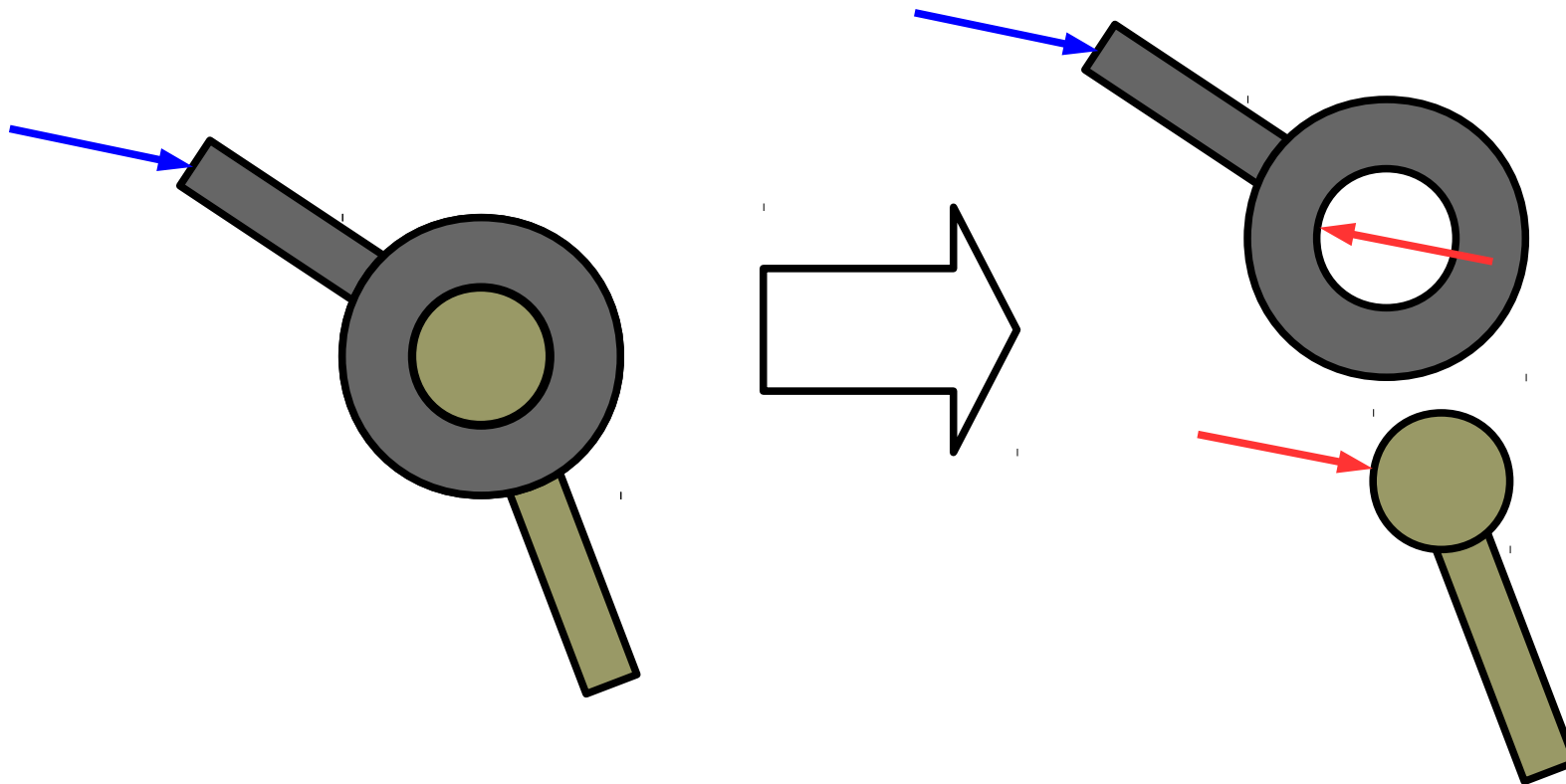

Dynamics of planar mechanisms

Reaction forces inside a kinematic pairs (without friction)

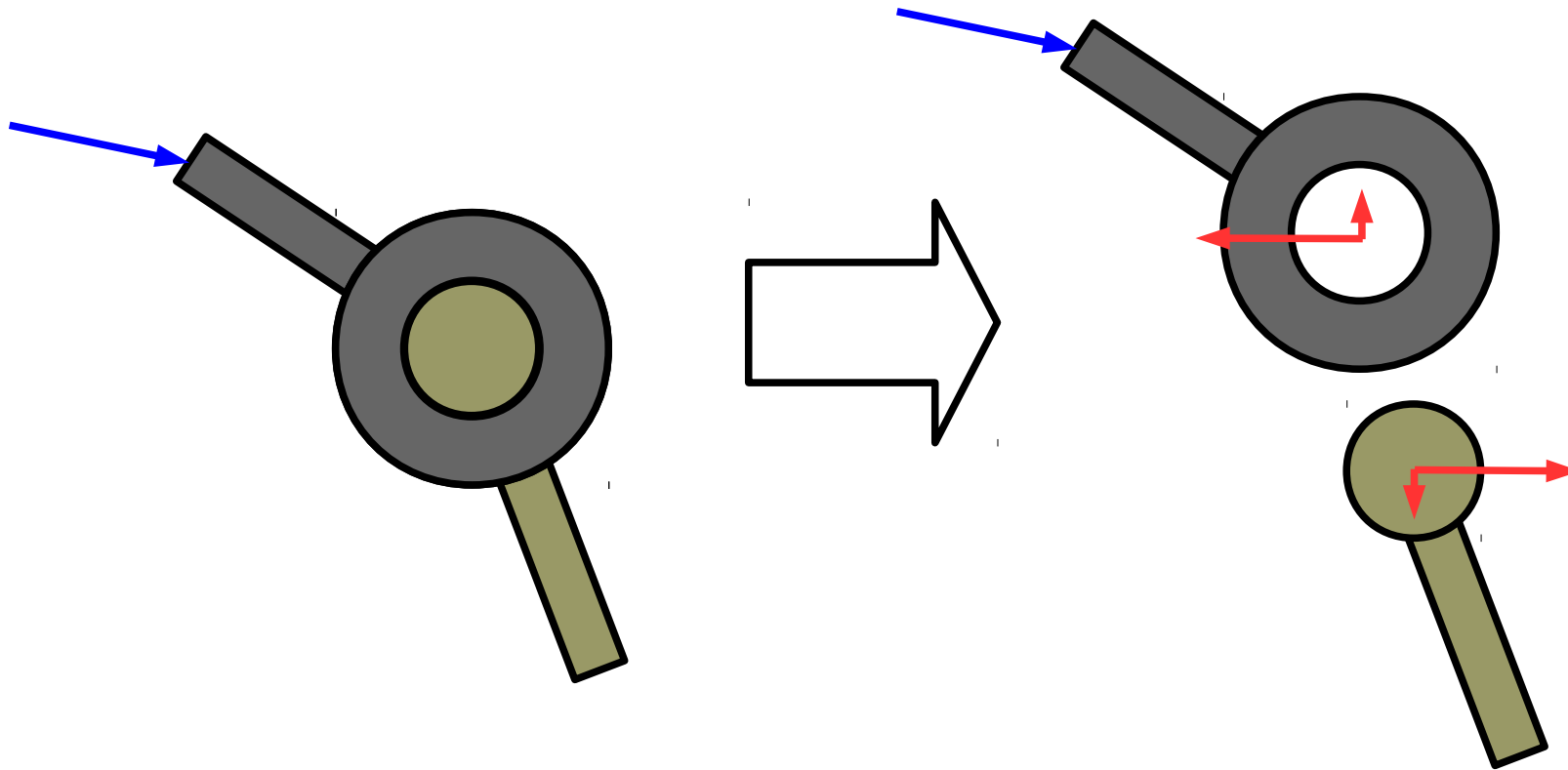

Dynamics of planar mechanisms

Driving and operating forces/torques

Dynamics of planar mechanisms

Driving and operating forces/torques

example – compressor

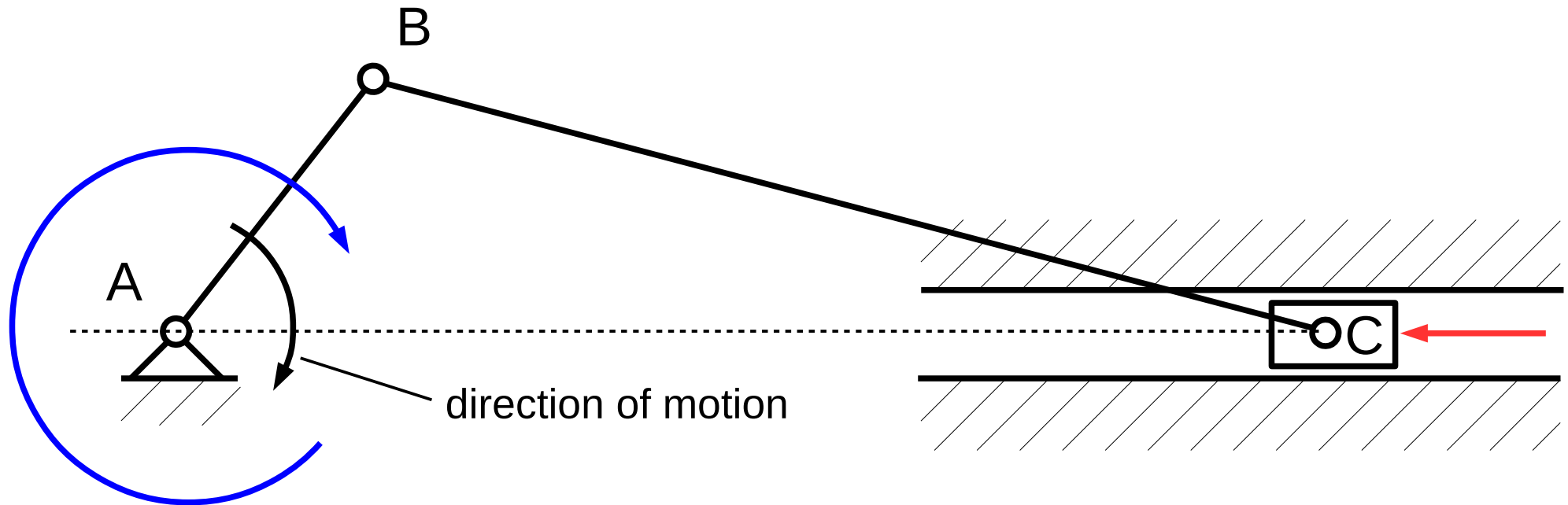

Dynamics of planar mechanisms

Driving and operating forces/torques

example – compressor

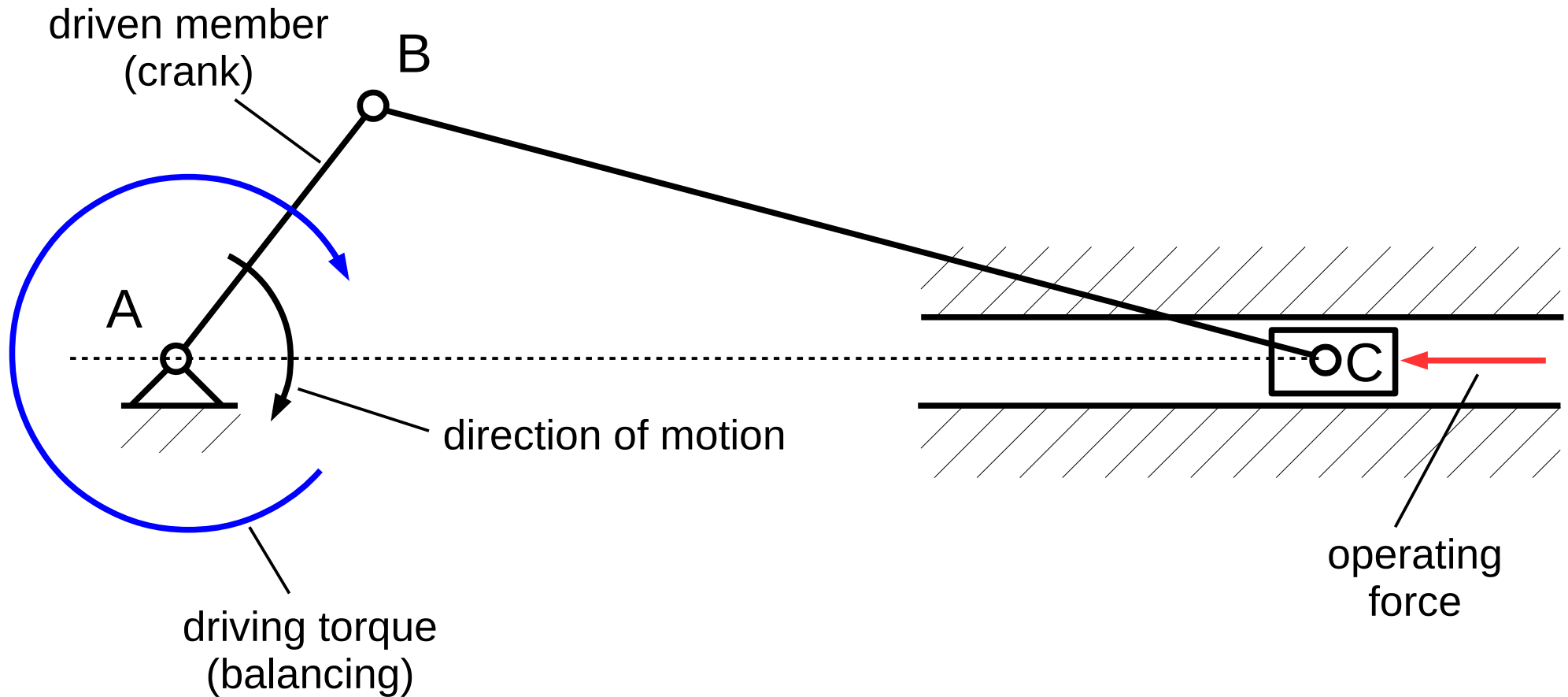

Dynamics of planar mechanisms

Driving and operating forces/torques

example – engine

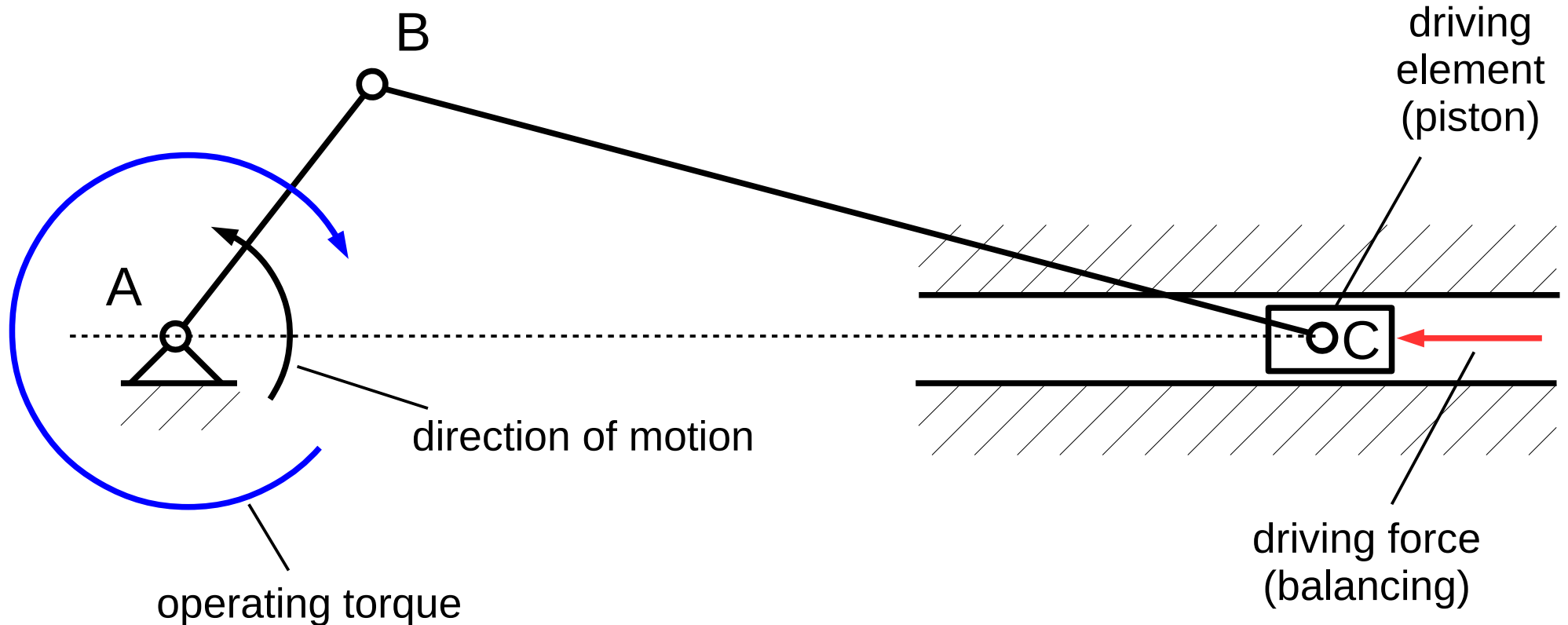

Dynamics of planar mechanisms

Inverse dynamics problem – calculation of forces and torques that cause given motion of a mechanism.

Direct dynamics problem – calculation of mechanism's motion caused by external forces and torques.

Dynamics of planar mechanisms

Inverse dynamics problem

Calculation of forces and torques that cause given motion of a mechanism (kinetostatics)

0. Mechanism and its geometry, driving and operating forces/torques, displacement, velocity and acceleration functions are given.
1. Calculation of inertia forces and torques acting moving members of the mechanism.
2. Decomposition of the mechanism with reaction disclosure.
3. Write down vector sums of external forces, reactions and inertia forces (d'Alembert equations).
4. Solve the equations with graphical and/or analytical method.

Dynamics of planar mechanisms

Inverse dynamic problem – example

Given:
geometry, mass, center of a mass locations, mass moments of inertia for all mechanism members, constant angular velocity ω of a driven element, operating force P .

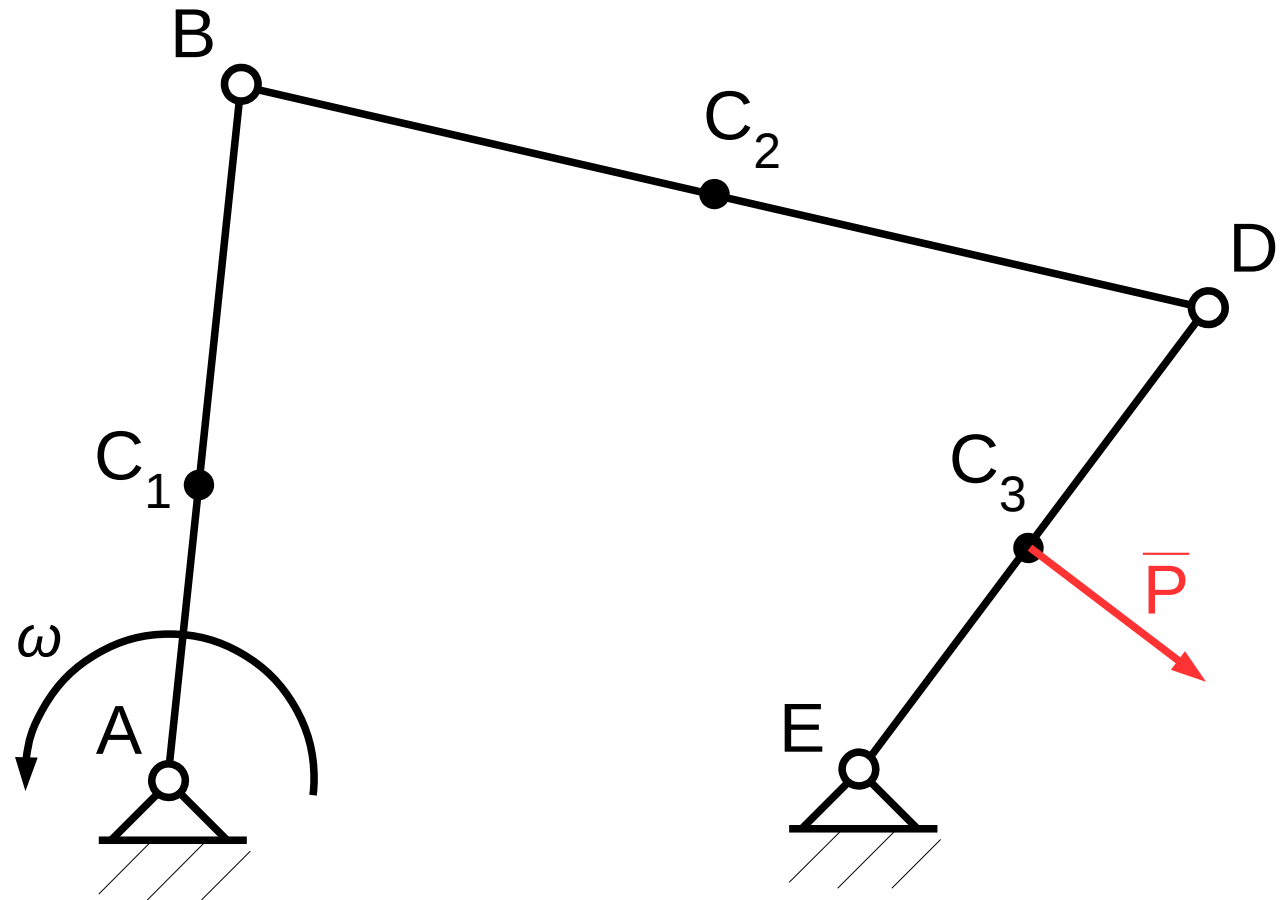

Dynamics of planar mechanisms

Inverse dynamic problem – example

velocity scheme

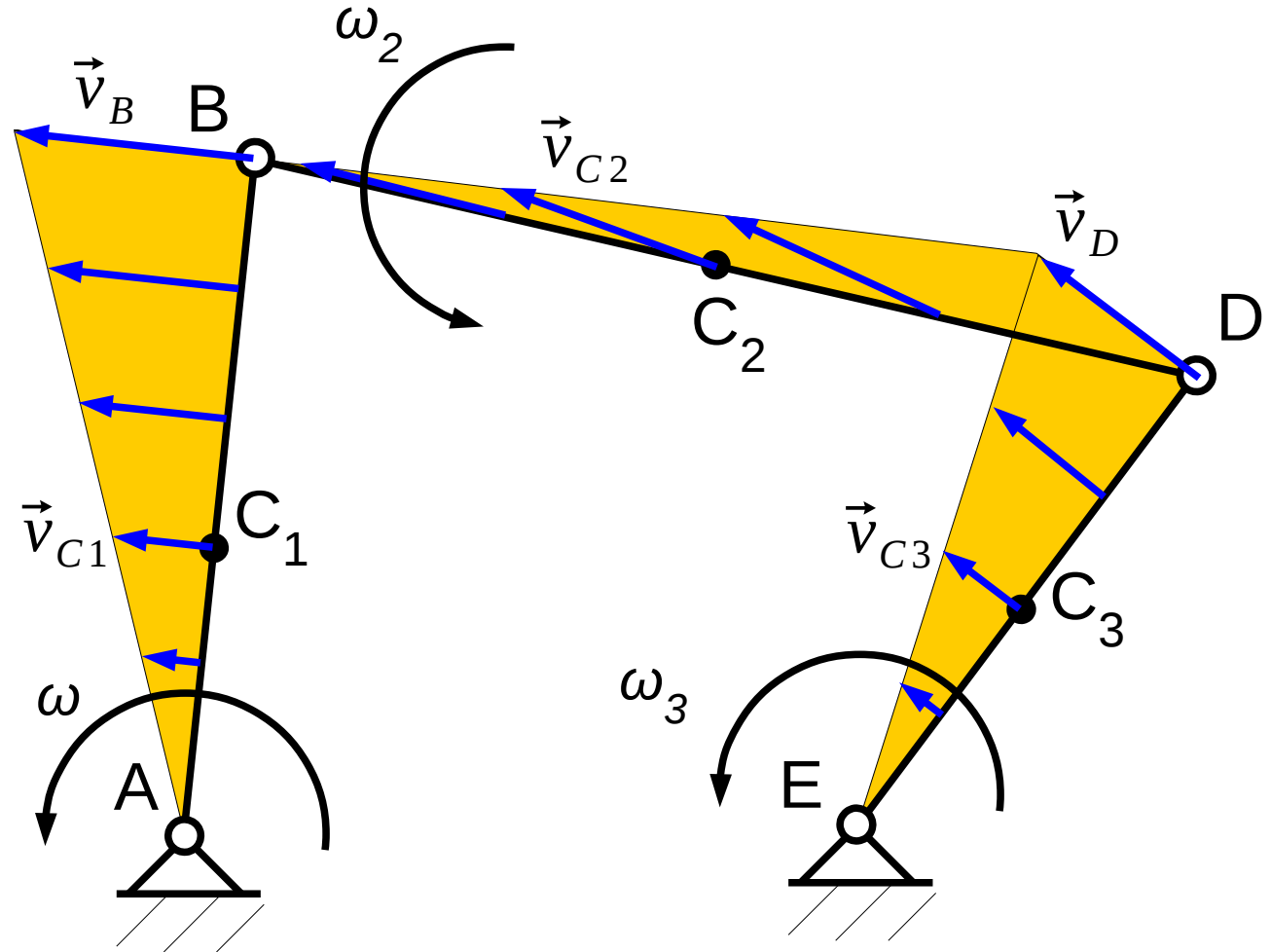

Dynamics of planar mechanisms

Inverse dynamic problem – example

acceleration scheme

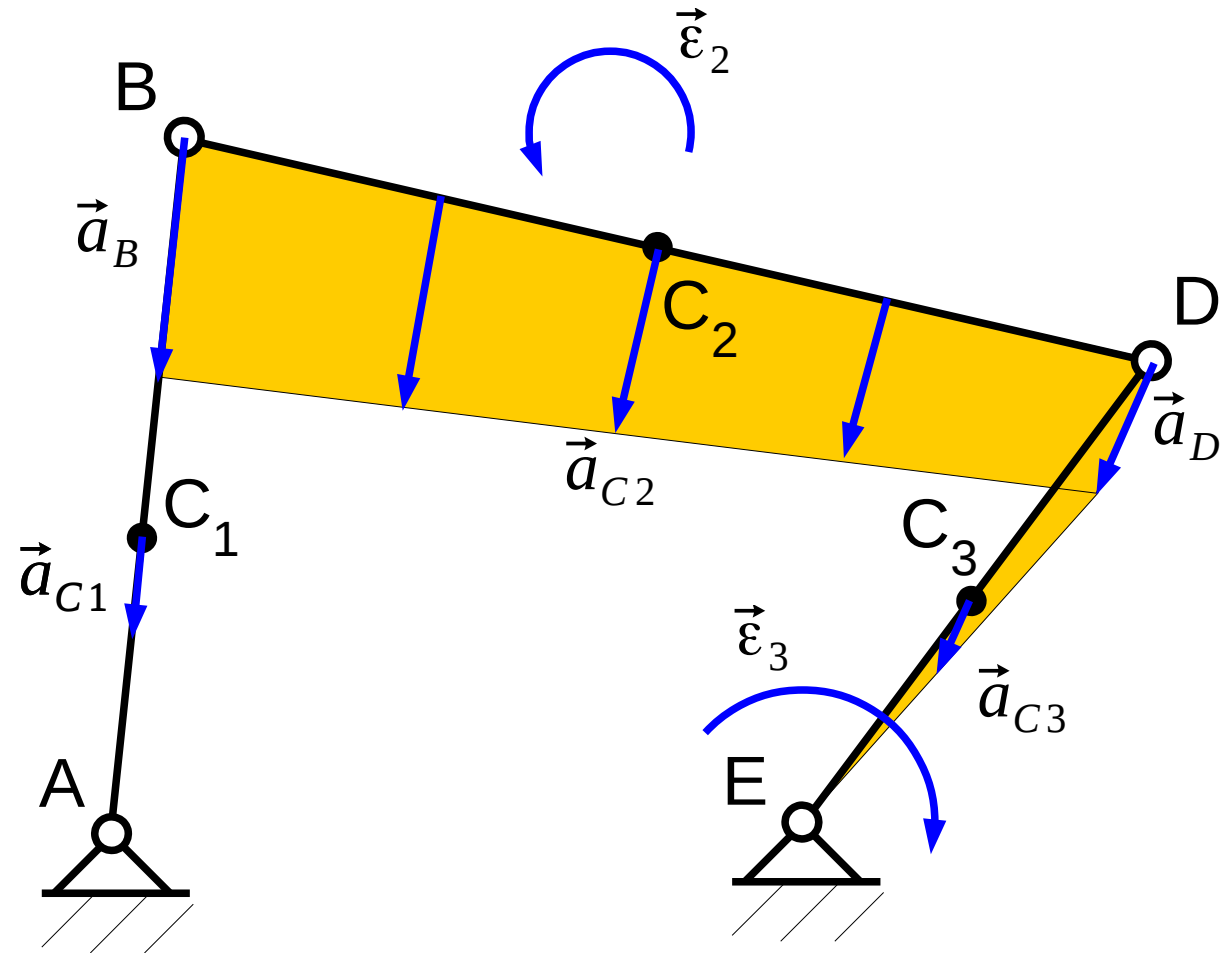

Dynamics of planar mechanisms

Inverse dynamic problem – example

inertial forces and torques

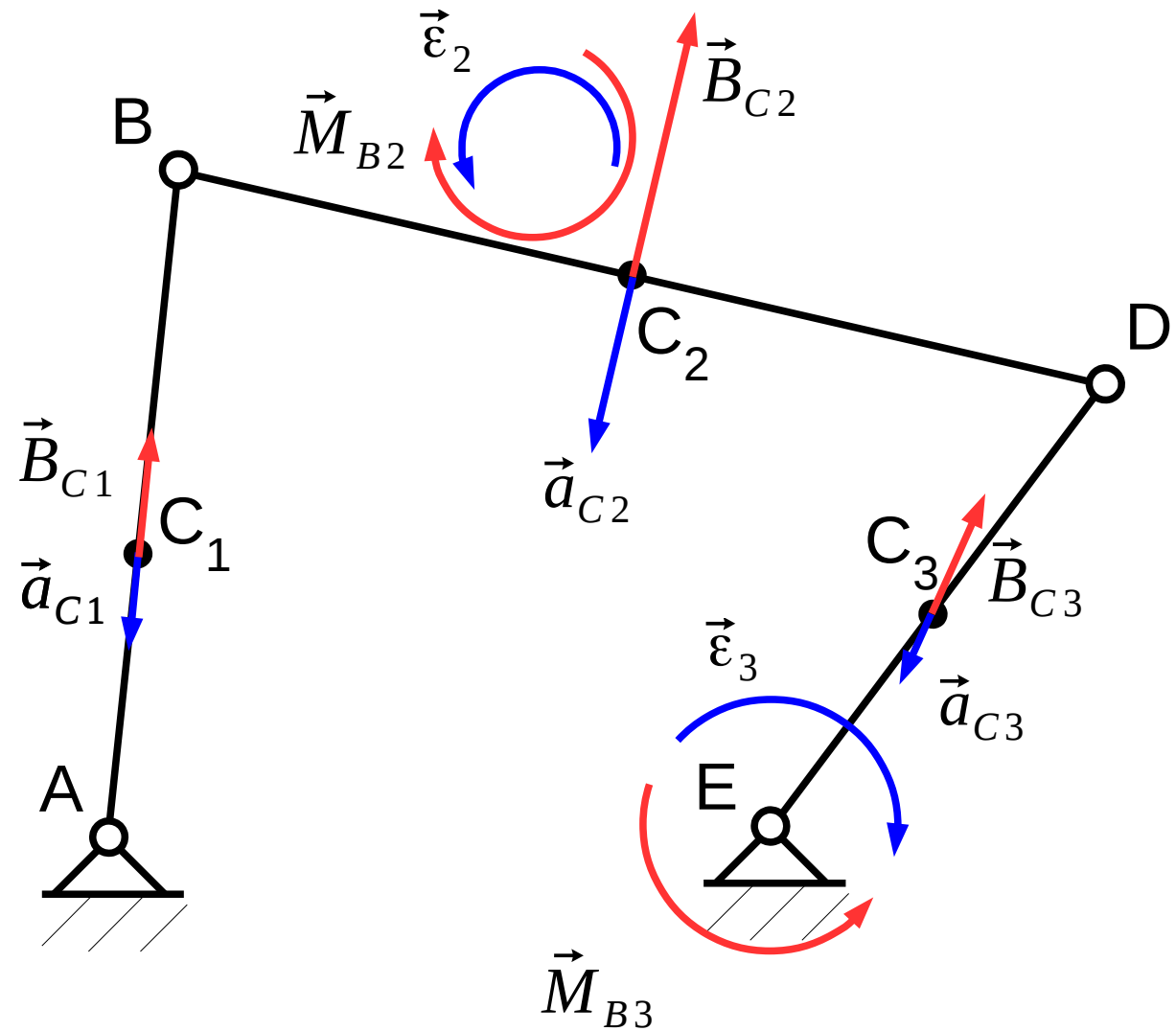

Dynamics of planar mechanisms

Inverse dynamic problem – example

inertial forces and torques

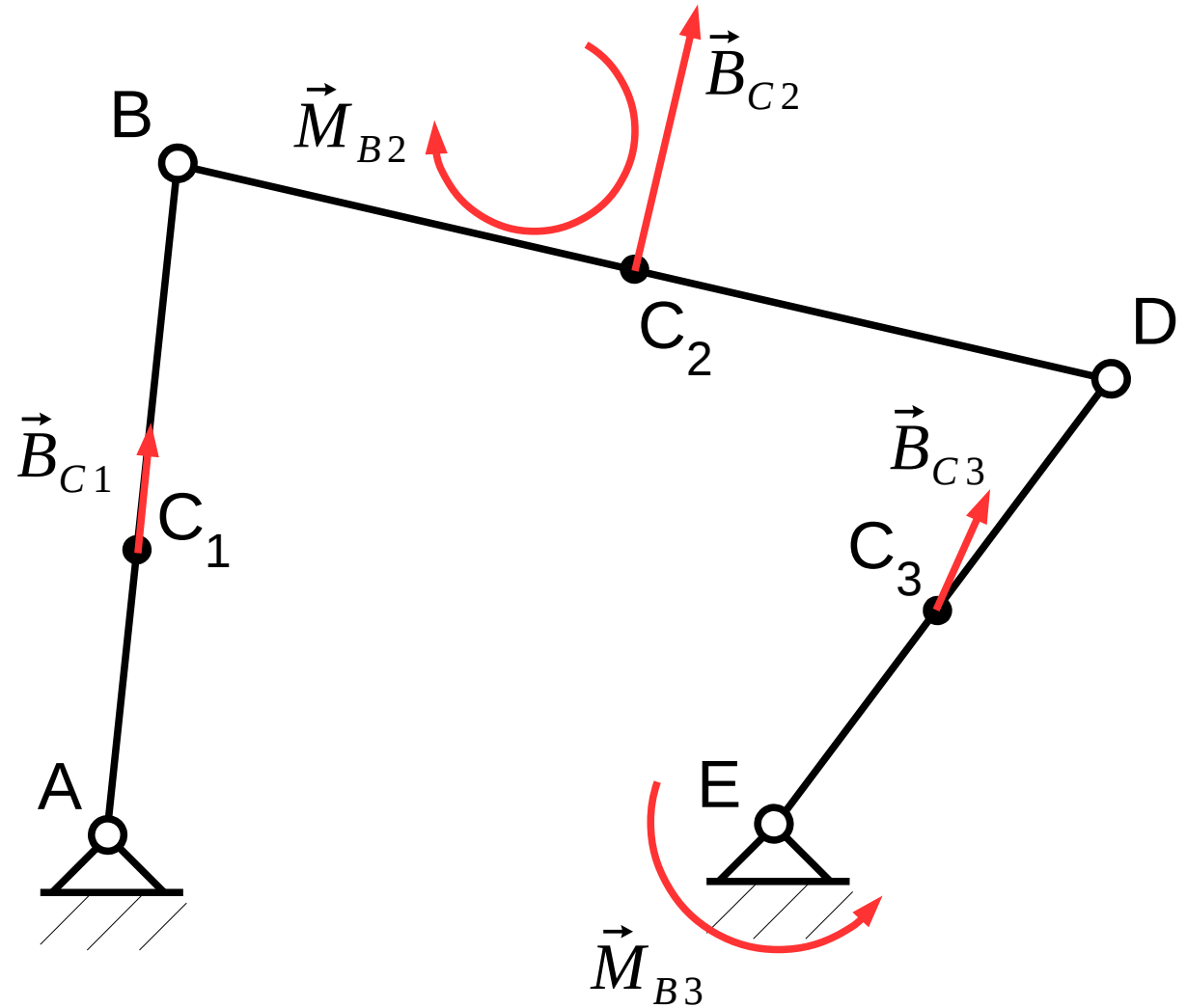

Dynamics of planar mechanisms

Inverse dynamic problem – example

inertial forces and torques
+
external and operating forces and torques

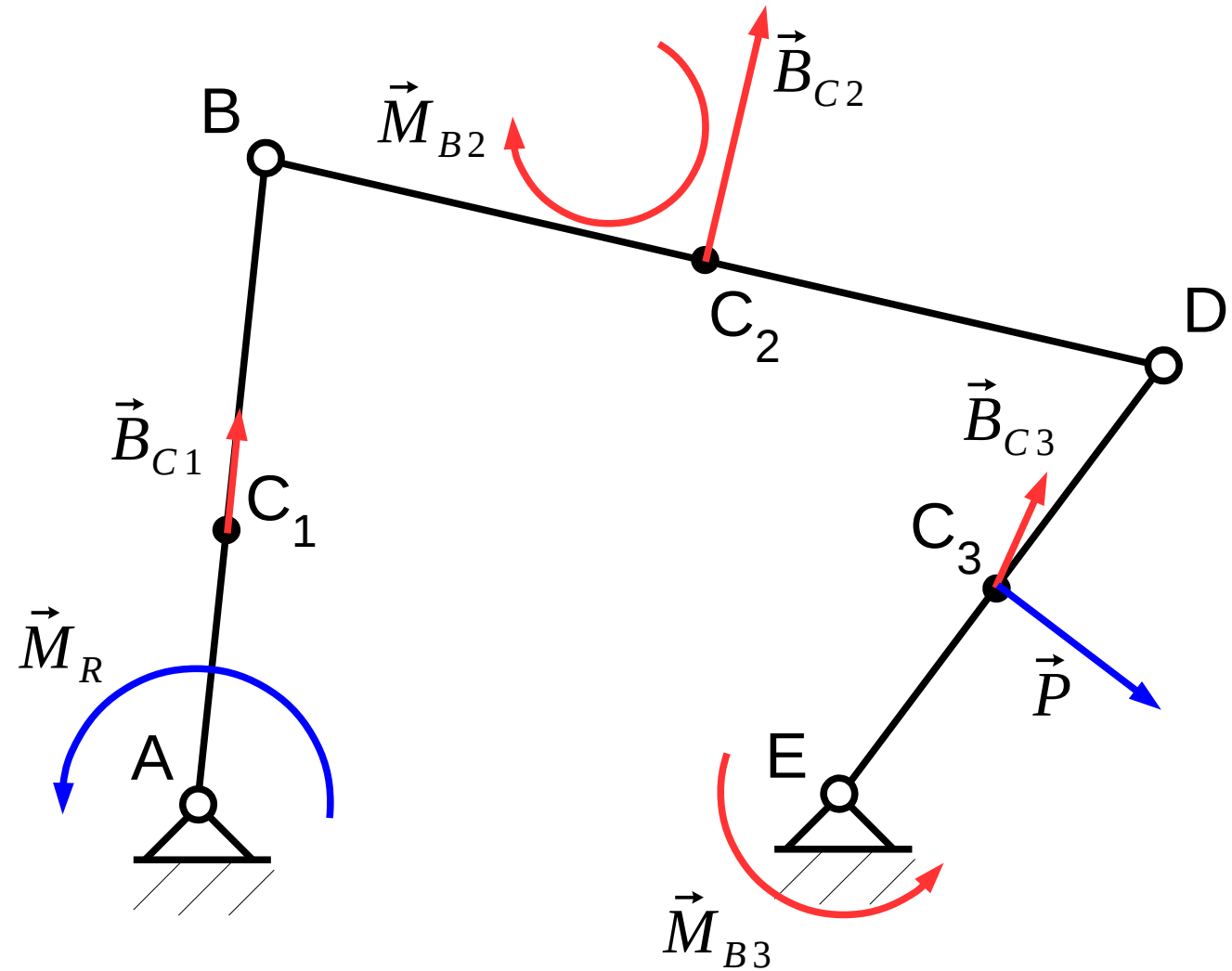

Dynamics of planar mechanisms

Inverse dynamic problem – example

Structural decomposition

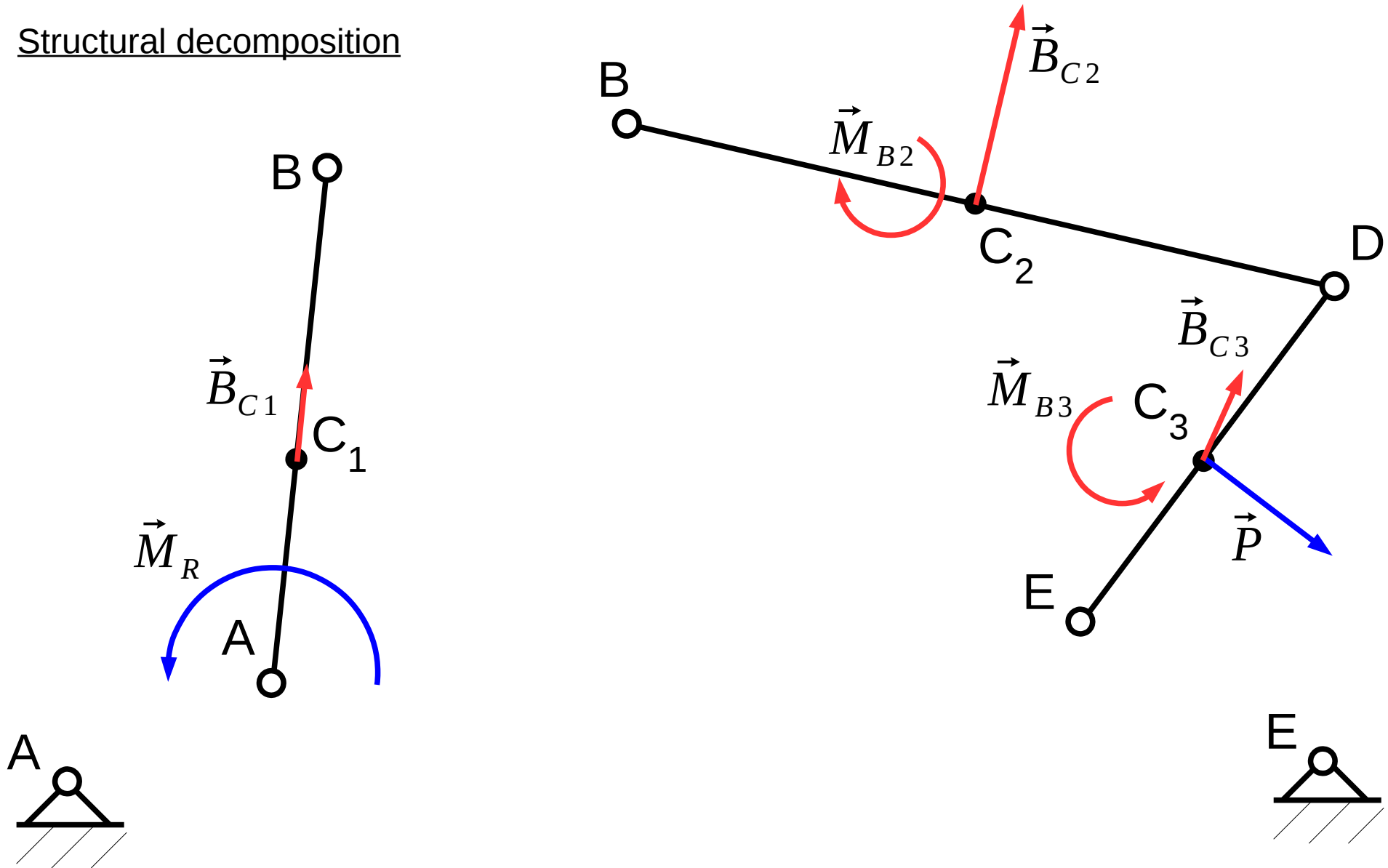

Dynamics of planar mechanisms

Inverse dynamic problem – example

Unknown
reaction forces

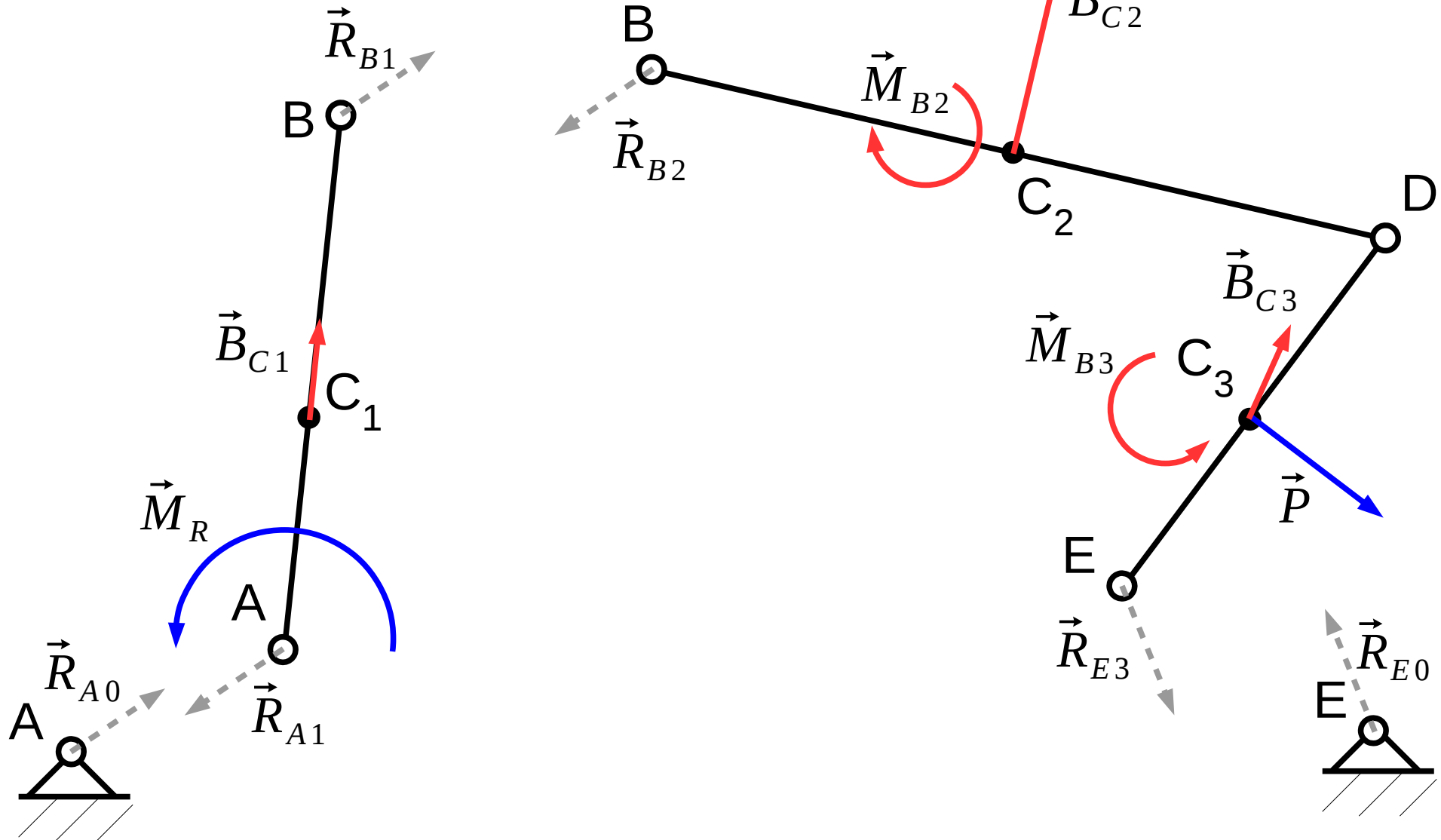

Dynamics of planar mechanisms

Inverse dynamic problem – example

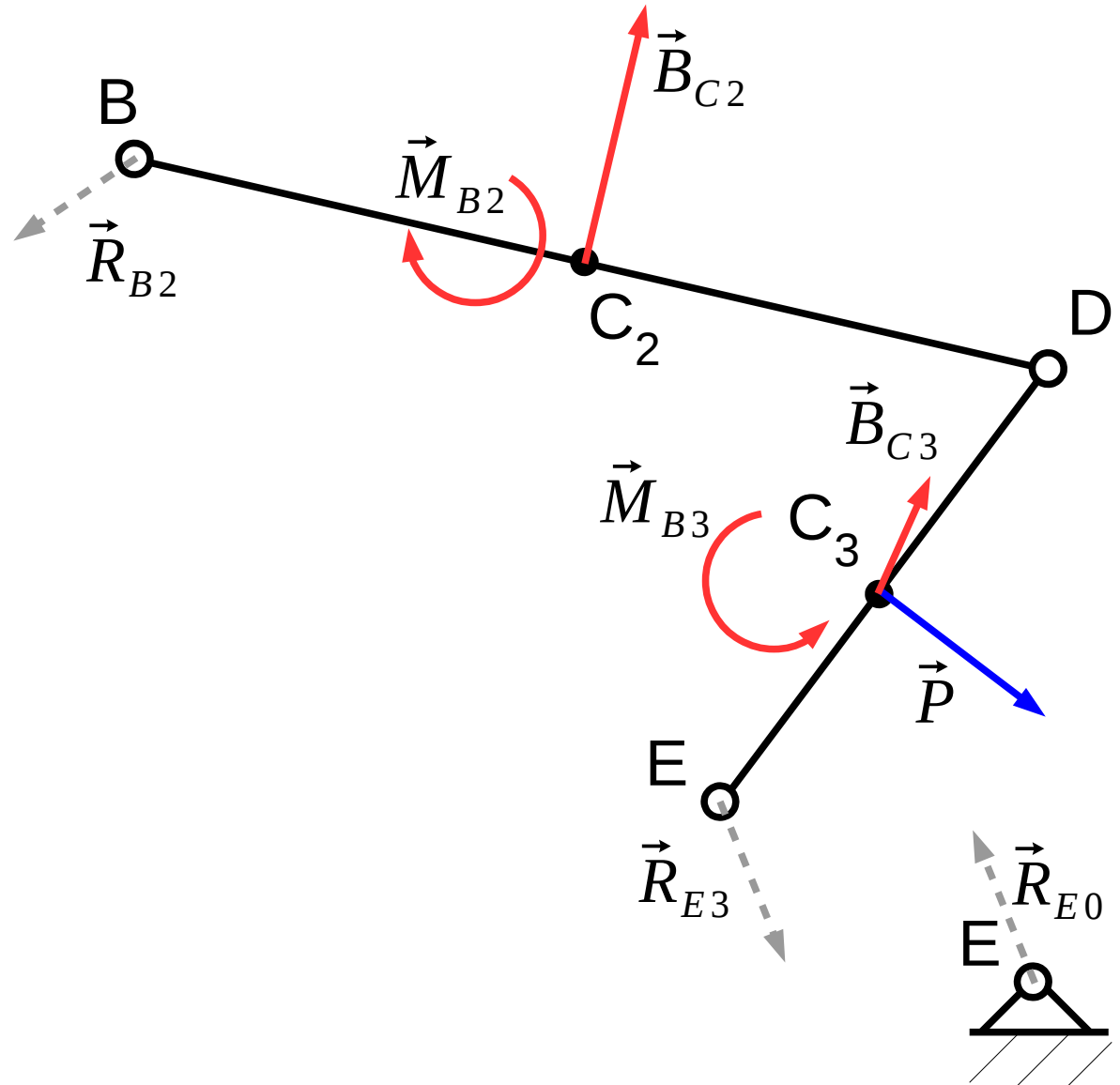

$$\vec{R}_{B2} + \vec{B}_{C2} + \vec{B}_{C3} + \vec{P} + \vec{R}_{E3} = 0$$

Dynamics of planar mechanisms

Inverse dynamic problem – example

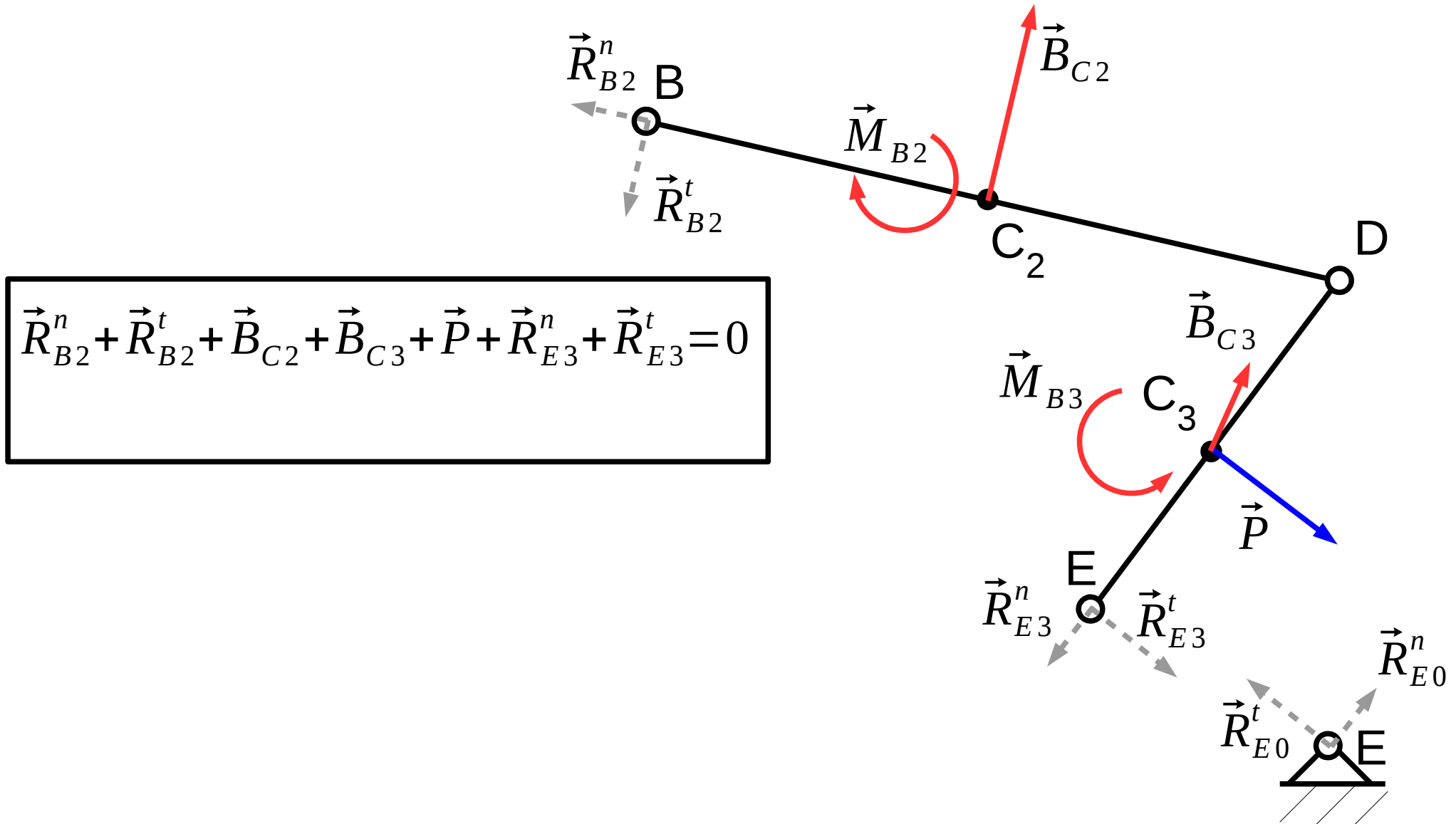

$$\vec{R}_{B2}^n + \vec{R}_{B2}^t + \vec{B}_{C2} + \vec{B}_{C3} + \vec{P} + \vec{R}_{E3}^n + \vec{R}_{E3}^t = 0$$

Dynamics of planar mechanisms

Inverse dynamic problem – example

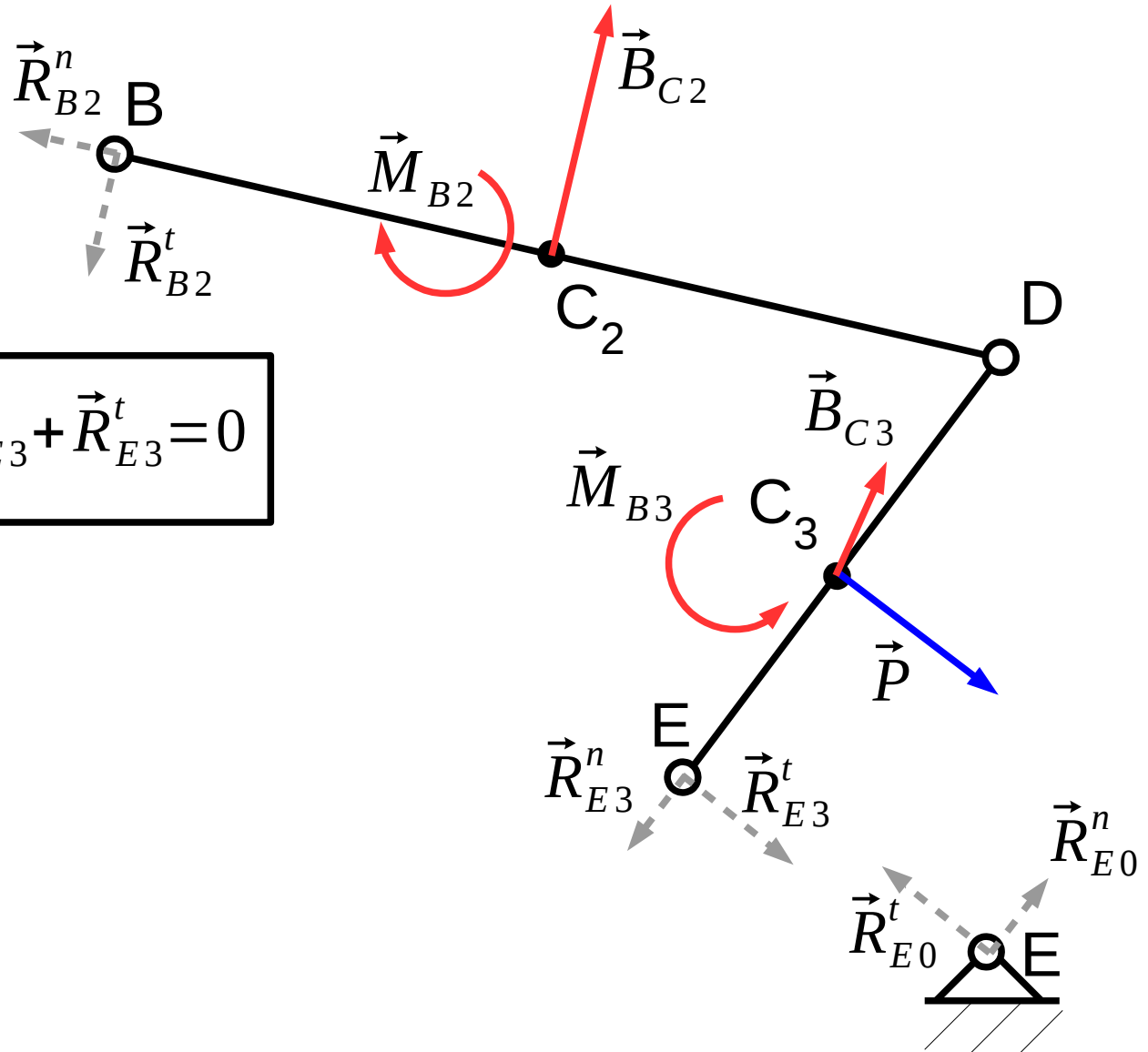

$$\vec{R}_{B2}^n + \vec{R}_{B2}^t + \vec{B}_{C2} + \vec{B}_{C3} + \vec{P} + \vec{R}_{E3}^n + \vec{R}_{E3}^t = 0$$

part BD: $\sum M_D : \dots$

$$\vec{R}_{B2}^t = \dots$$

part ED: $\sum M_D : \dots$

$$\vec{R}_{E3}^t = \dots$$

Dynamics of planar mechanisms

Inverse dynamic problem – example

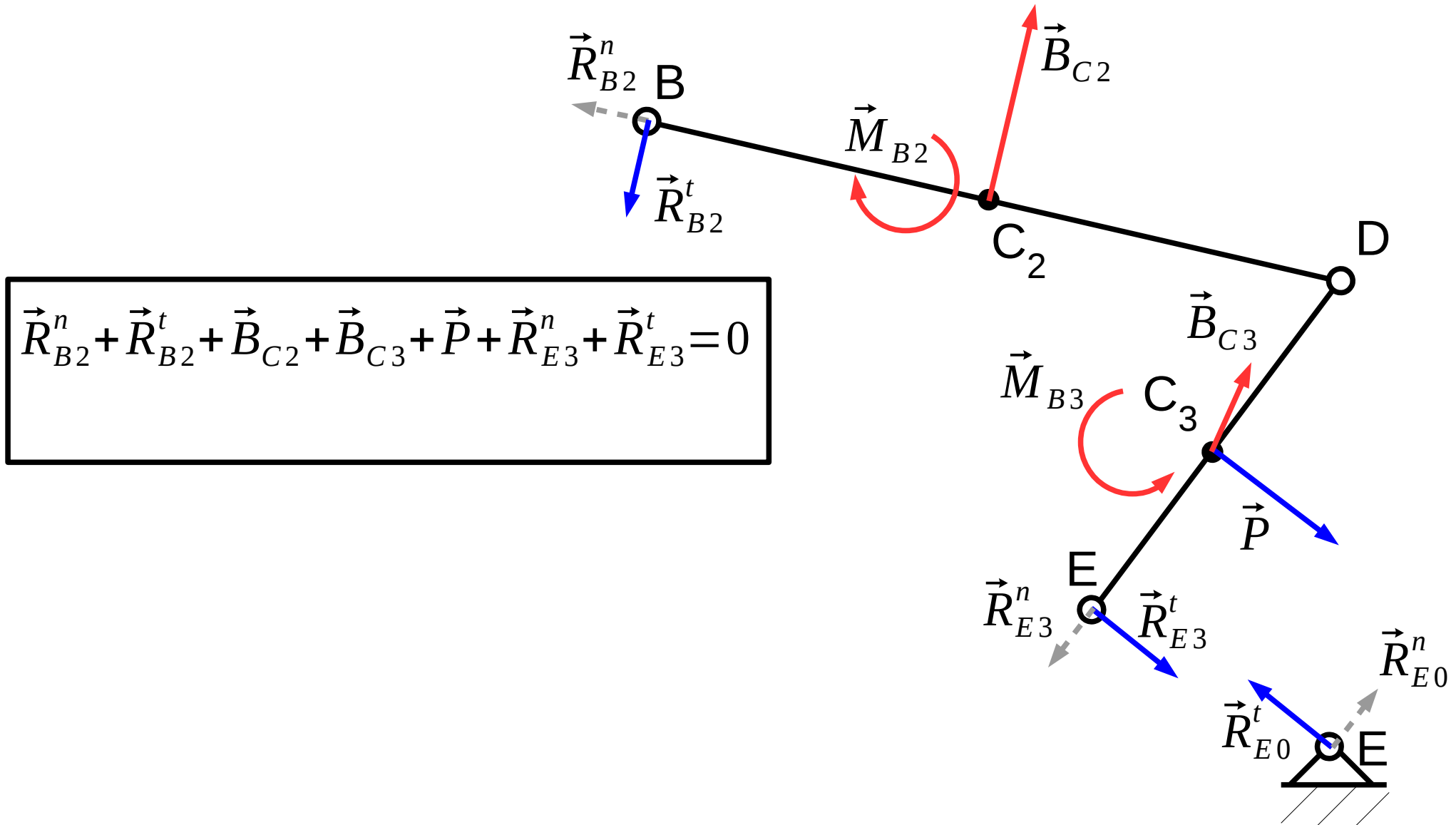

Dynamics of planar mechanisms

Inverse dynamic problem – example

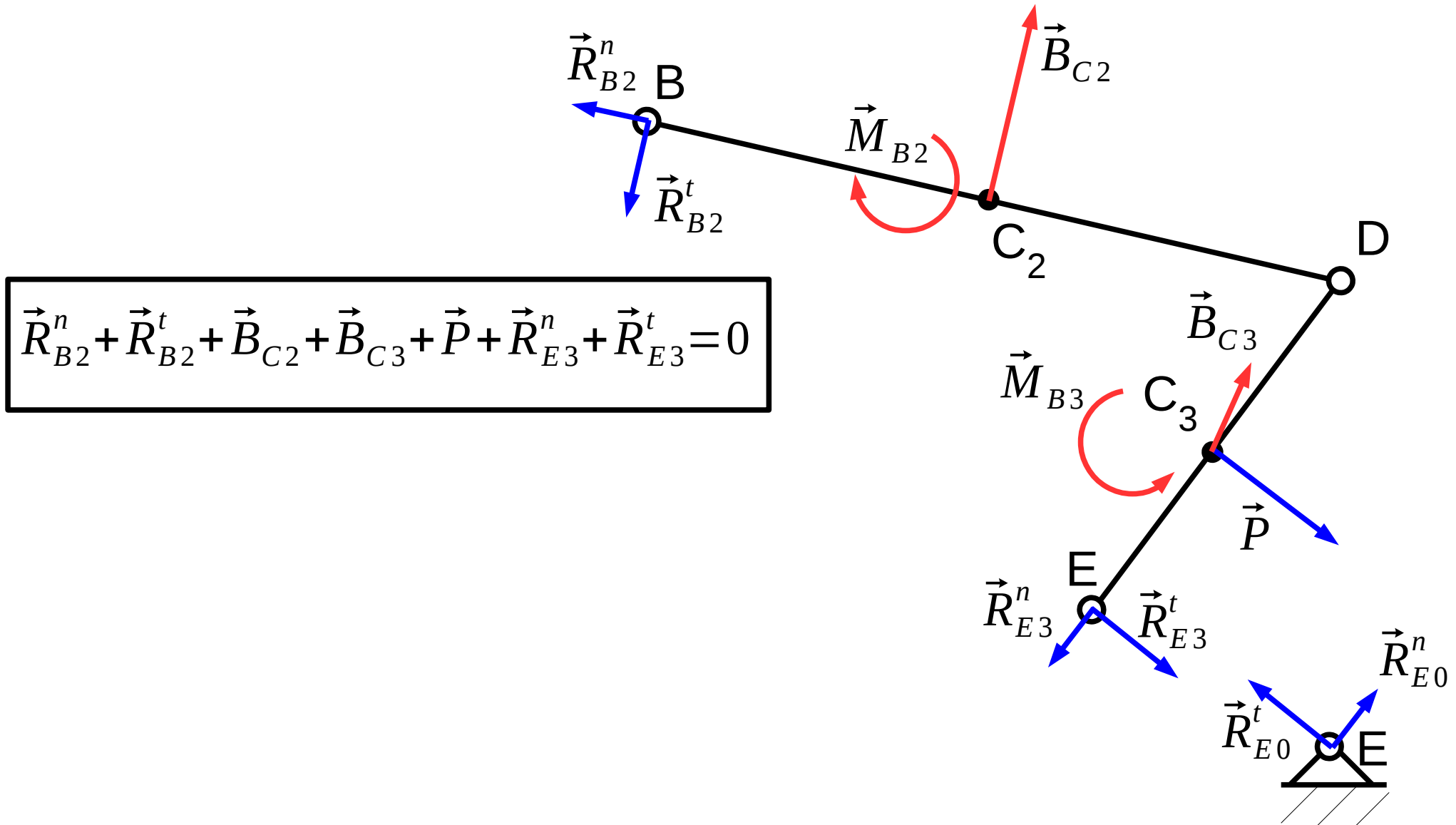

$$\vec{R}_{B2}^n + \vec{R}_{B2}^t + \vec{B}_{C2} + \vec{B}_{C3} + \vec{P} + \vec{R}_{E3}^n + \vec{R}_{E3}^t = 0$$

Dynamics of planar mechanisms

Inverse dynamic problem – example

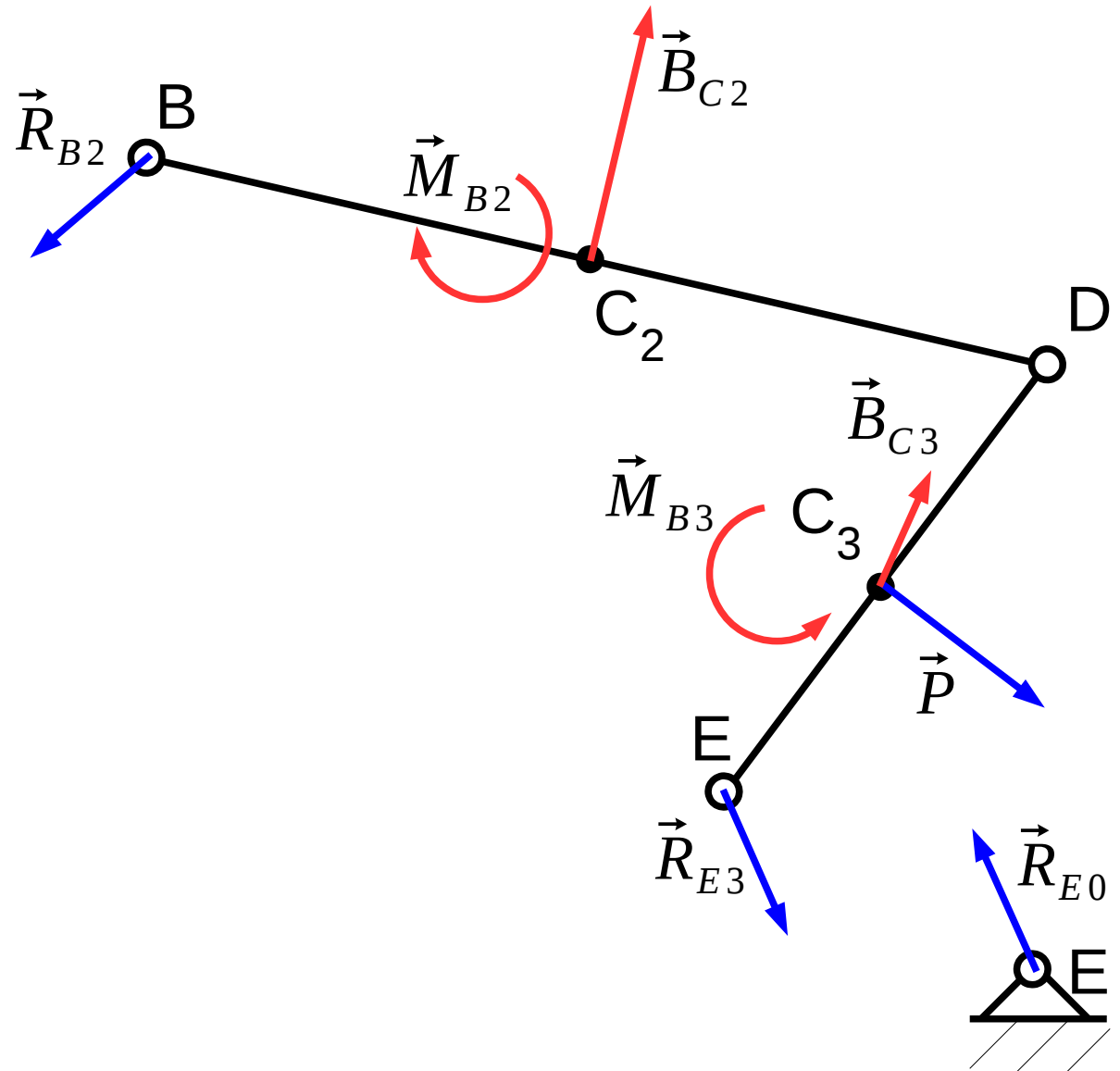

Dynamics of planar mechanisms

Inverse dynamic problem – example

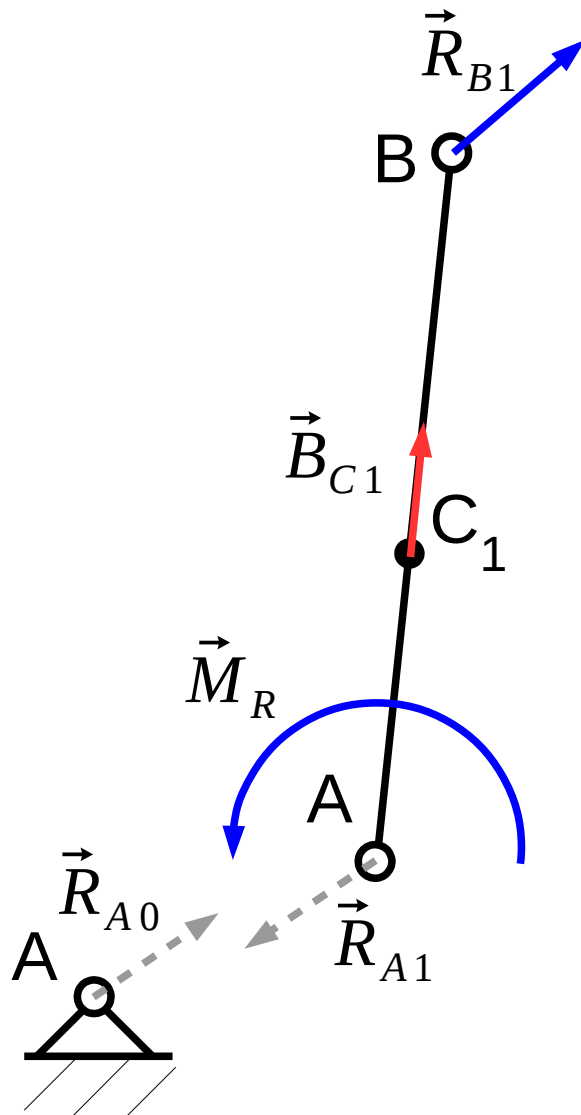

$$\text{part } AB: \vec{R}_{A1} + \vec{B}_{C1} + \vec{R}_{B1} = 0$$

Dynamics of planar mechanisms

Inverse dynamic problem – example

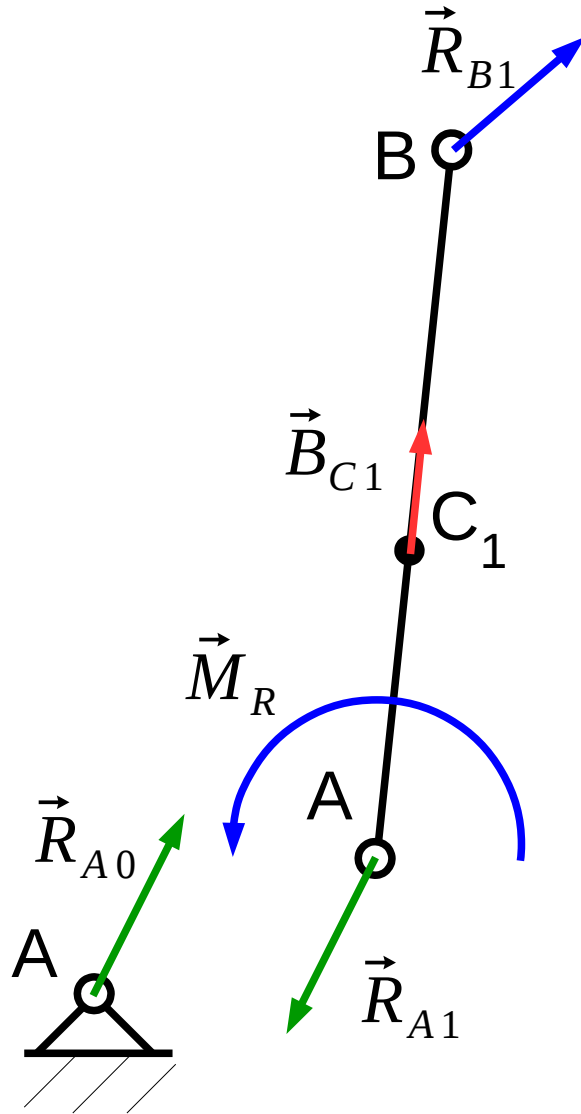

$$\sum M_A : \dots$$

$$M_R = \dots$$